

UNIFLOW-200 MFC



Flow Computer

for closed conduit and open channel flow measurement

Instruction Manual

Process Control Kft.
H -2142 Nagytarcsa Déri Miksa utca 10. A/7.
Phone: 36 20 945 2477
E-mail: info@processcontrol.hu
Web: www.processcontrol.hu

Revision tracking sheet

October 2023

This manual may be revised periodically to incorporate new or updated information. Listed below are the revision dates:

Revision	Date	Firmware version
Initial issue	Jun 2008	
Rev.1	Jan 2010	
Rev.2	Jan 2011	
Rev.3	Jun 2013	
Rev.4	July 2015	150619
Rev.5	June 2019	190702 and above
Rev.5a	July 2019	190702 and above
Rev.5b	December 2019	190702 and above
Rev.5c	February 2020	200213 and above
Rev.5d	February 2020	200213 and above
Rev.5e	April 2020	200213 and above
Rev.5f	October 2020	201020 and above
Rev.6	April 2021	210401 and above
Rev.6a	June 2021	210608 and above
Rev.6b	October 2021	210608 and above
Rev.6c	November 2021	211123 and above
Rev.6d	January 2022	220121 and above
Rev.6e	April 2022	220404 and above
Rev.6f	July 2022	220711 and above
Rev.6g	October 2022	221017 and above
Rev.6h	November 2022	221112 and above
Rev.7	December 2022	221207 and above
Rev.7a	May 2023	230519 and above
Rev.7b	July 2023	230519 and above
Rev.7c	October 2023	231030 and above

While information in this Instruction Manual is presented in good faith and believed to be accurate, Process Control Kft. does not guarantee satisfactory results from reliance upon such information. *Nothing contained herein is to be construed as a warranty or guarantee, express or implied, regarding the performance, merchantability, fitness or any other matter with respect to the products.* Process Control Kft. reserves the right, without notice, to alter or improve the designs or specifications of the products described herein.

Table of Contents

1	About this manual	14
2	Introduction.....	15
3	Technical specification.....	17
3.1	General features	17
3.2	Technical data	17
3.3	Accessories.....	20
4	Plug-in boards and hardware operation.....	21
4.1	Plug-in boards	21
4.2	Hardware operation.....	23
5	Installation, wiring and start-up	25
5.1	Installation.....	25
5.2	Wiring	25
5.3	Start-up.....	27
5.4	Start and stop metering streams	27
6	Basic operation.....	28
6.1	Keypad	28
6.1.1	Numeric keys	28
6.1.2	Editing keys.....	28
6.1.3	Function keys	29
6.2	Display	29
6.2.1	Navigating the display.....	31
6.3	Data security	31
6.3.1	Hardware write lock switch.....	31
6.3.2	Enabling write lock switch.....	33
6.3.3	Software security levels	34
6.4	The menu system.....	35
6.5	Entering data	41
6.5.1	Changing numeric data.....	41
6.5.2	Changing selection	41
6.6	Data pages	42
7	Maintenance and troubleshooting	43
8	Support.....	44
8.1	U200ToolBox.....	44
8.1.1	UNISetup	44
8.1.2	UNIArchive.....	44
8.1.3	UNIUpdate	44
9	Detailed operation – The menu tree	45
9.1	Flow	45
9.1.1	Stream data.....	45
9.1.1.1	Summary display 1, 2, 3 and 4	45
9.1.1.2	Periodic totals	46

9.1.1.3	Flow rates	46
9.1.1.4	Cumulative totals.....	47
9.1.1.5	Premium totals.....	48
9.1.1.6	Fault totals	48
9.1.1.7	Process data	49
9.1.1.7.1	Flow meter data.....	49
9.1.1.7.2	Fluid data	51
9.1.1.7.3	Gas composition related data pages	53
9.1.2	Plant I/O	54
9.1.3	Archive data	58
9.1.3.1	Archived periodic totals.....	58
9.1.3.2	Archived batch data.....	59
9.1.4	Modbus registers	60
9.1.5	Data transfer.....	60
9.1.6	Extra summary display.....	62
9.1.7	Batches.....	63
9.1.7.1	Tank loading batch	63
9.1.7.2	Pipeline interface batch	64
9.1.8	Flow meter serial test and flow computer calibration	65
9.1.8.1	Flow meter serial test.....	65
9.1.8.2	Flow computer calibration.....	67
9.1.9	PID	70
9.2	Parameters.....	71
9.2.1	I/O signal setup	72
9.2.1.1	Analogue (4-20 mA) input channel.....	72
9.2.1.2	PRT/RTD input channel.....	75
9.2.1.3	Pulse input channel.....	76
9.2.1.4	Pulse output channel.....	82
9.2.1.5	Digital input channel	83
9.2.1.6	Digital output channel	85
9.2.1.7	Analogue (4-20 mA) output channel	90
9.2.1.8	HART signal input channel.....	91
9.2.1.9	Modbus signal channel.....	94
9.2.2	Stream setup.....	96
9.2.2.1	Physical stream setup	96
9.2.2.1.1	Fluid selection.....	96
9.2.2.1.2	Flow meter selection.....	125
9.2.2.1.3	Stream setup.....	140
9.2.2.1.4	Premium limits.....	175
9.2.2.1.5	Limits	176
9.2.2.2	Virtual stream setup.....	177
9.2.2.2.1	Virtual stream setup	178

9.2.2.2.2	Virtual stream Premium limits	179
9.2.2.2.3	Virtual stream Limits	180
9.2.2.3	Premium mode setup	181
9.2.2.4	Fault mode setup.....	182
9.2.2.5	Barometric pressure.....	182
9.2.2.6	Averaging	183
9.2.2.7	Totals format	184
9.2.3	General data	185
9.2.3.1	Date and time.....	185
9.2.3.2	Timezone.....	185
9.2.3.3	Periods setting	186
9.2.3.4	User defined setup	187
9.2.3.4.1	Display	187
9.2.3.4.2	Reports	191
9.2.3.4.3	Trends	195
9.2.3.5	Password setup	195
9.2.3.6	Reset	196
9.2.3.6.1	Totals reset	196
9.2.3.6.2	General reset	197
9.2.3.7	Version control	198
9.2.3.8	Company data.....	198
9.2.3.9	LCD settings.....	199
9.2.3.10	Character type.....	200
9.2.4	Interfaces.....	201
9.2.4.1	Serial ports.....	201
9.2.4.2	Ethernet port.....	204
9.2.4.3	USB	205
9.2.5	Operator parameters	205
9.2.5.1	Keypad & limits	205
9.2.5.2	Keypad values	206
9.2.6	Restore	208
9.2.7	PID Control.....	209
9.2.7.1	Operation of the PID control	209
9.2.7.1.1	Single loop controller.....	209
9.2.7.1.2	Dual loop controller	209
9.2.7.2	Calculation algorithm of the controller.....	213
9.2.7.3	Set up the PID control	214
9.2.7.3.1	General set up.....	214
9.2.7.3.2	Output	215
9.2.7.3.3	Operation.....	216
9.2.7.3.4	Fault handling	219
9.2.7.3.5	Tuning	219

9.2.7.4	Operation of the PID control	220
9.2.7.4.1	Operation of single loop controller	221
9.2.7.4.2	Operation of dual loop controller	222
9.2.7.5	Modbus register map of the PID control parameters	225
9.3	Alarms and events system	228
9.3.1	I/O channel alarms	229
9.3.1.1	Analog input channel (4-20 mA) alarms	229
9.3.1.2	PRT/RTD (Pt100) channel alarms	229
9.3.1.3	Pulse input channel (flow pulse signal) alarms	229
9.3.1.4	Pulse input channel (flow frequency signal) alarms	230
9.3.1.5	Pulse input channel (density frequency signal) alarms	230
9.3.1.6	Analog output (4-20 mA) channel alarms	231
9.3.1.7	Pulse output channel alarms	231
9.3.1.8	Modbus (serial communication) channel alarms	231
9.3.2	Metering stream alarms	232
9.3.2.1	Calculation alarms	232
9.3.2.2	Stream fault alarm	232
9.3.3	Common alarm and status output	232
9.3.3.1	Status output	233
9.3.4	Alarm list	233
9.3.5	Events list	235
9.3.6	Download log	235
9.4	Tests	237
9.4.1	Tests – ANI4PT2 board	237
9.4.2	Tests – ANI8 board	238
9.4.3	Tests – PT4 board	238
9.4.4	Tests – AODIO484 board	239
9.4.5	Tests – PDIO484 board	239
9.4.6	Tests – PITC4641 board	240
9.4.7	Tests – Com port monitor	241
9.4.8	Tests – Modbus TCP monitor	243
9.5	Calibration	244
9.5.1	Rosemount 3095 calibration	244
9.6	Help	247
9.7	Language/Nyelv/Язык/Limba	248
10	Communication	249
10.1	Serial link setup	250
10.2	Ethernet link setup	250
10.3	Communication device address	250
10.4	Protocol implementation	252
10.4.1	Implemented Modbus command codes	252
10.4.1.1	Read multiply registers (code: 3)	252

10.4.1.2	Write multiply registers (code: 16).....	252
10.4.2	Calculation of CRC check sum.....	253
10.4.3	Data types in the Modbus registers.....	254
10.4.3.1	8 bit binary unsigned integer.....	254
10.4.3.2	16 bit binary unsigned integer.....	254
10.4.3.3	32 bit binary signed integer.....	254
10.4.3.4	Floating point number.....	254
10.5	Standard Modbus register map (2 byte/register).....	255
10.5.1	Accessing periodic totals.....	265
10.5.2	Accessing batch data.....	267
10.5.2.1	Accessing batch data in case of “Tank loading/unloading” batch.....	267
10.5.2.2	Accessing batch data in case of “Pipeline product interface” batch.....	268
10.5.3	Accessing flow meter serial test data.....	269
10.6	Daniel Modbus register map (4 byte/register).....	272
10.6.1	Registers for system date and time modification via Modbus link.....	272
10.6.2	Registers for totals.....	272
10.6.3	Registers for other measured data.....	275
10.7	Register maps of the Modbus Slave devices.....	278
10.7.1	Register map of Caldon LEFM 380Ci ultrasonic meter.....	278
10.7.2	Register map of Daniel ultrasonic meter (Mark III electronics).....	281
10.7.3	Register map of Flexim Fluxus ultrasonic meter.....	283
10.7.4	Register map of Sick-Maihak Flowsic-600 ultrasonic meter.....	283
10.7.5	Register map of Krohne Altosonic V12 ultrasonic meter.....	285
10.7.6	Register map of Panametrics GC868 ultrasonic meter.....	287
10.7.7	Register map of Instromet QSonic Uniform ultrasonic meter.....	288
10.7.8	Register map of Instromet QSonicPlus ultrasonic meter.....	288
10.7.9	Register map of RMA Ecosonic12 ultrasonic meter.....	290
10.7.10	Register map of RMG USZ08 ultrasonic meter.....	292
10.7.11	Register map of Siemens 1010GCGDN ultrasonic meter.....	294
10.7.12	Register map of Sick FLOWSIC-600XT ultrasonic meter.....	295
10.7.13	Register map of FMC MPU Series B ultrasonic meter.....	299
10.7.14	Register map of ABB NGC820X gas chromatograph.....	300
10.7.15	Register map of ABB2 gas chromatograph.....	301
10.7.16	Register map of Daniel Danalyzer C6+ gas chromatograph.....	302
10.7.17	Register map of Daniel Danalyzer C9+ gas chromatograph.....	303
10.7.18	Register map of Yamatake HGC gas chromatograph.....	303
10.7.19	Register map of Yokogawa gas chromatograph.....	304
10.7.20	Register map of Elster EnCal3000 gas chromatograph.....	305
10.7.21	Register map of Emerson 3095FB multiparameter transmitter.....	307
10.7.22	Register map of Krohne MFC300 mass flow meter transmitter.....	307
10.7.23	Register map of Emerson Micromotion mass flow meter.....	308
Annex A.	Reports.....	310

Annex B. User report editor	320
1. Connecting UNIFLOW-200 to PC.....	321
2. Selecting the report for editing.....	322
3. Report settings.....	323
3.1. Report refresh rate.....	324
3.2. Report archiving period.....	324
3.3. Date format	324
4. Defining report items	324
4.1. Machine.....	326
4.2. Date	326
4.3. Table	326
4.4. Stream data (M01...M12).....	329
4.4.1. Stream name.....	329
4.4.2. Actual/Previous period data	330
5. Accessing user defined reports.....	331
5.1. Saving reports to PC by UNIArchive.....	332
5.2. Saving reports to flash drive.....	334
5.3. Printing reports to serial printer	334
5.4. Printing reports to serial printer when the report generated	334
6. Sample user defined report.....	335
Annex C User Modbus editor	341
1. Adding User Modbus table to parameter project	341
2. Editing User Modbus table.....	341
3. Assigning User Modbus table to communication ports.....	346
4. Checking User Modbus register content on the display	347
Annex D. Application notes for HTI4x15 I/O board	349
Annex E. Drawings	350

Table of Figures

Figure 4-1 I/O board locations	23
Figure 5-2 Backplane connectors.....	26
Figure 6-3 Front panel.....	28
Figure 6-4 Menu page.....	30
Figure 6-5 Data page.....	30
Figure 6-6 Hardware write lock switch.....	31
Figure 6-7 Write lock switch status.....	32
Figure 6-8 Write lock message on display	33
Figure 6-9 Write lock message on ToolBox	33
Figure 6-10 Write lock switch status by default.....	34
Figure 6-10 Enabling write lock switch	34
Figure 6-10 Main menu page	35
Figure 6-11 Main menu – Flow	37
Figure 6-12 Main menu - Parameters.....	40
Figure 6-13 Main menu – Alarm and events, Tests, Calibration, Help, Language	41
Figure 7-14 Fuses.....	43
Figure 9-15 The default summary display	45
Figure 9-16 Periodic totals	46
Figure 9-17 Flow rates	47
Figure 9-18 Cumulative totals.....	47
Figure 9-19 Premium totals.....	48
Figure 9-20 Fault totals	49
Figure 9-21 Process data menu page.....	49
Figure 9-22 Flow meter data for differential pressure devices (orifice, nozzle, Venturi tube)	50
Figure 9-23 Flow meter data for pulse output flow meters (turbine meter, Vortex meter, etc.).....	50
Figure 9-24 Flow meter data (Flowsic-600 US meter, serial communication)	51
Figure 9-25 Fluid data for natural gas.....	52
Figure 9-26 Fluid data for crude oil and refined products.....	52
Figure 9-27 Fluid data for ethanol.....	52
Figure 9-28 Fluid data for general liquid	53
Figure 9-29 Fluid data for liquid mixture.....	53
Figure 9-30 Fluid data for water steam	53
Figure 9-31 In-use gas composition data for natural gas	54
Figure 9-32 Externally received gas composition data for natural gas	54
Figure 9-33 Keypad gas composition data for natural gas	54
Figure 9-34 I/O board <i>n</i> data page for ANI8 board.....	55
Figure 9-35 I/O board <i>n</i> data page for ANI4PT2 board	55
Figure 9-36 I/O board <i>n</i> data page for PDIO484 board.....	56
Figure 9-37 I/O board <i>n</i> data page for AODIO484 board	56
Figure 9-38 Modbus signal data page	57
Figure 9-39 Archive data data page	58
Figure 9-40 Archive batch data page	59
Figure 9-41 Modbus registers data page	60
Figure 9-42 Data transfer data page	61
Figure 9-43 Extra summary display	62
Figure 9-44 Tank loading/unloading system with batch measurement	63
Figure 9-45 Batch display for tank loading/unloading.....	63
Figure 9-46 Batch display for pipeline interface batch	64
Figure 9-47 Flow meter serial test measurement	65
Figure 9-48 Meter serial test display in Master (left) and Slave (right)	66
Figure 9-49 Flow computer calibration.....	68
Figure 9-50 Meter serial test display, flow computer calibration.....	69
Figure 9-51 Analogue (4-20 mA) input channel data page	72
Figure 9-52 Error curve data page for flow rate signal	73
Figure 9-53 PRT/RTD input channel data page.....	75
Figure 9-54 Pulse input channel (signal type = flow pulse) data page.....	77
Figure 9-55 Error curve data page (signal type = flow pulse).....	78
Figure 9-56 Pulse input channel (signal type = flow check pulse) data page.....	79

Figure 9-57 Pulse input channel (signal type = flow frequency) data page	79
Figure 9-58 Error curve data page (signal type = flow frequency)	81
Figure 9-59 Pulse input channel (signal type = density frequency) data page	81
Figure 9-60 Pulse output channel data page.....	83
Figure 9-61 Digital input channel (signal type = dual state) data page	83
Figure 9-62 Digital input channel (signal type = pulse) data page.....	84
Figure 9-63 Digital output channel (signal type = pulse) data page.....	85
Figure 9-64 Digital output channel (signal type = STR FR alarm) data page.....	86
Figure 9-65 Digital output channel (signal type = STR fault alarm) data page.....	87
Figure 9-66 Digital output channel (signal type = Analog input alarm) data page	87
Figure 9-67 Digital output channel (signal type = Digital input alarm) data page.....	88
Figure 9-68 Digital output channel (signal type = Common alarm) data page	88
Figure 9-69 Digital output channel (signal type = Time base) data page.....	89
Figure 9-70 Digital output channel (signal type = Batch control) data page.....	89
Figure 9-71 Analogue (4-20 mA) output channel data page.....	90
Figure 9-72 HART input channel data page	91
Figure 9-73 Error curve data page for flow rate signal	92
Figure 9-74 Modbus channel data page	95
Figure 9-75 Stream selection data page	96
Figure 9-76 Natural gas data page (metric example)	97
Figure 9-77 Natural gas data page (imperial example)	97
Figure 9-78 Natural gas detailed gas composition menu page.....	99
Figure 9-79 Natural gas composition selection data page.....	99
Figure 9-80 Natural gas keypad composition data page	99
Figure 9-81 Natural gas Modbus registers data page	100
Figure 9-82 Natural gas limited gas composition data page	101
Figure 9-83 Natural gas plausibility limits data page.....	101
Figure 9-84 Coke oven gas composition data page.....	113
Figure 9-85 Blast furnace gas composition data page.....	114
Figure 9-86 Predefined pure gas data page	115
Figure 9-87 General gas data page.....	115
Figure 9-88 Water steam data page for superheated and saturated steam.....	116
Figure 9-89 Water data page.....	117
Figure 9-90 Crude oil and product data page	118
Figure 9-91 Ethanol data page	121
Figure 9-92 General liquid data page.....	122
Figure 9-93 Liquid mixture data page.....	123
Figure 9-94 Orifice plate meter data page.....	126
Figure 9-95 Nozzle data page	128
Figure 9-96 Venturi tube data page.....	130
Figure 9-97 Segmental orifice plate data page.....	131
Figure 9-98 V-Cone meter data page	132
Figure 9-99 Compact/conditioning orifice plate data page	133
Figure 9-100 Annubar data page.....	134
Figure 9-101 Verabar data page.....	136
Figure 9-102 Accelabar data page.....	137
Figure 9-103 Gas turbine meter, Liquid turbine meter, Vortex meter, Mass flow meter, Ultrasonic meter, Rotameter, Electromagnetic meter, CVOL flow meter, Stream data page.....	138
Figure 9-104 Flow meter with power characteristic data page	139
Figure 9-105 Stream flow meter definition in Stream setup menu	140
Figure 9-106 Stream setup data page, fluid: natural gas, flow meter: orifice meter	144
Figure 9-107 Stream disabling and transmitter calibration data page.....	144
Figure 9-108 Stream setup data page, fluid: natural gas, flow meter: turbine meter.....	151
Figure 9-109 Stream setup data page, fluid: natural gas, flow meter: ultrasonic meter	156
Figure 9-110 Stream setup data page, fluid: crude oil, flow meter: liquid turbine.....	162
Figure 9-111 Stream setup data page, fluid: crude oil, flow meter: mass flow meter.....	168
Figure 9-112 Stream setup data page, fluid: electric power, flow meter: electrical power meter	173
Figure 9-113 Premium limits data page	176
Figure 9-114 Limits data page	176
Figure 9-115 Virtual stream selection data page.....	177

Figure 9-116	Virtual stream setup data page.....	178
Figure 9-117	Virtual stream premium limits data page.....	180
Figure 9-118	Virtual stream limits data page.....	180
Figure 9-119	Premium mode setup data page.....	181
Figure 9-120	Fault mode setup data page.....	182
Figure 9-121	Barometric pressure data page.....	183
Figure 9-122	Averaging setup data page.....	184
Figure 9-123	Totals format setup data page.....	184
Figure 9-124	Date and time data page.....	185
Figure 9-125	Time zone data page.....	185
Figure 9-126	Time periods data page.....	186
Figure 9-127	Summary display setup data page.....	187
Figure 9-128	Display editing data page, General display.....	188
Figure 9-129	Display editing data page, Previous month display.....	189
Figure 9-130	Display editing data page, Current month display.....	190
Figure 9-131	Extra summary display setup data page.....	191
Figure 9-132	User defined report selection data page.....	192
Figure 9-133	User report editing data page for User report 1 and 2.....	192
Figure 9-134	User report editing data page for User reports 3 to 10.....	193
Figure 9-135	Password setup data page.....	195
Figure 9-136	Totals reset data page.....	196
Figure 9-137	Pre-set cumulative totals.....	197
Figure 9-138	General reset data page.....	197
Figure 9-139	Version control data page.....	198
Figure 9-140	User data data page.....	199
Figure 9-141	LCD settings data page in different colours.....	200
Figure 9-142	Character size selection data page.....	200
Figure 9-143	Serial ports data page.....	201
Figure 9-144	Ethernet port data page.....	205
Figure 9-145	Operator data - limits data page.....	206
Figure 9-146	Keypad values data page.....	207
Figure 9-147	Restore data page.....	208
Figure 9-148	Single variable control loop.....	209
Figure 9-149	Dual loop controller with outlet pressure control.....	210
Figure 9-150	Dual loop controller with inlet pressure control.....	211
Figure 9-151	Dual loop controller for bidirectional flow.....	213
Figure 9-152	PID control loop general setup.....	214
Figure 9-153	PID control loop general setup, parameter group selection.....	215
Figure 9-154	PID control loop setup, output.....	215
Figure 9-155	PID control loop setup, analogue output.....	216
Figure 9-156	PID control loop setup, operation, single loop.....	216
Figure 9-157	PID control loop setup, operation, dual loop.....	217
Figure 9-158	PID control loop setup, fault handling.....	219
Figure 9-159	PID control loop setup, tuning.....	220
Figure 9-160	Accessing PID control operation screen.....	221
Figure 9-161	PID control operation, control loop inactive screen.....	221
Figure 9-162	PID control operation, single loop controller.....	221
Figure 9-163	PID control operation, dual loop controller.....	222
Figure 9-164	PID control operation, dual loop controller, PIC loop.....	223
Figure 9-165	PID control operation, dual loop controller, FIC loop.....	224
Figure 9-166	Tests – main menu page.....	237
Figure 9-167	Tests – ANI4PT2 board data page.....	237
Figure 9-168	Tests – ANI8 board data page.....	238
Figure 9-169	Tests – PT4 board data page.....	238
Figure 9-170	Tests – AODIO484 board data page.....	239
Figure 9-171	Tests – PDIO484 board data page.....	240
Figure 9-172	Tests – PITC4641 board data page.....	240
Figure 9-173	Tests – Com port monitor, setup.....	241
Figure 9-174	Tests – Com port monitor, traffic.....	241
Figure 9-175	Tests – Com port monitor, scrolling.....	242

Figure 9-176 Tests – Modbus TCP port monitor, setup	243
Figure 9-177 Transmitter calibration display	244
Figure 9-178 Sensor calibration display	245
Figure 9-179 DP sensor offset calibration display	245
Figure 9-180 DP sensor offset calibration finished display	245
Figure 9-181 DP sensor slope calibration display	246
Figure 9-182 DP sensor slope calibration finished display	246
Figure 9-183 DP sensor damping display	246
Figure 9-184 DP sensor damping finished display	247
Figure 9-185 DP sensor calibration finished display	247
Figure 9-186 Calibration finished display	247
Figure 9-187 Language change display	248

Table of Tables

Table 4-1 I/O board types	21
Table 4-2 Communication interfaces	22
Table 9-3 Natural gas properties modes.....	109
Table 9-4 Ranges of gas mixture characteristics for compression factor calculation from detailed gas composition	111
Table 9-5. Ranges of gas mixture characteristics for compression factor calculation from limited set of gas composition.....	112
Table 9-6 Coke oven gas composition	113
Table 9-7 Blast furnace gas composition	113
Table 9-8 CTL and CPL modes, base temperature and base pressure options for liquid hydrocarbons	119
Table 9-9 Default values of the calorific value and CO ₂ emission factors	120
Table 9-10 Type of steels in GOST standards	128
Table 9-11 Unit of measurements for volume, mass and energy	143
Table 9-12 Stream data for general summary display.....	189
Table 9-13 Stream data for previous month summary display.....	190
Table 9-14 Stream data for current month summary display	191
Table 9-15 Modbus register map of the PID control parameters	227
Table 10-16 Communication device addresses	251

1 About this manual

This manual introduces the UNIFLOW-200 multifunction flow computer. It describes the installation procedure and shows how to operate the system including entering and modifying data. Basic maintenance and troubleshooting information is also provided. The information in this manual is arranged as follows:

Section 2 – Introduction provides an overview of the UNIFLOW-200 including the list of metering standards, fluids and flow meters available in the flow computer for configuration.

Section 3 – Technical specification contains a complete list of physical, performance, and environmental specifications of the UNIFLOW-200.

Section 4 – Plug-in boards and hardware operation provides the list of I/O boards available for selection together with their I/O channel capabilities. This section consists of the short description of the hardware operation of the flow computer.

Section 5 – Installation and wiring provides instruction on installing the UNIFLOW-200. It describes the field wiring configurations.

Section 6 – Basic operation shows how to use the UNIFLOW-200. This includes keypad functions, screen displays, system initialization, display navigation, data entry, and printing reports.

Section 7 – Maintenance and troubleshooting provides maintenance and troubleshooting information, including the basic board-level test procedures.

Section 8 – Support describes the software tools provide for the convenience of operation of the UNIFLOW-200.

Section 9 – Detailed operation – The menu tree describes in depth the menu structure of the UNIFLOW-200. It guides through the steps required to setup the UNIFLOW-200 for a particular flow measurement task. It gives the full list of options available for selection in the setup procedure.

Section 10 – Communication describes the communication capabilities of the UNIFLOW-200.

Annex A – Reports gives examples of the periodic reports available in the UNIFLOW-200 for uploading and printing.

Annex B – User report editor explains the operation of the user report editor available on the web server of UNIFLOW-200.

Annex C – User Modbus editor explains the operation of the Modbus editor available on the ToolBox and allowing create tailored Modbus register tables.

Annex D – Application notes for HT14x15 I/O board

Annex E – Drawings includes the drawings.

2 Introduction

UNIFLOW-200 multifunction flow computer is designed to measure flow of fluids flowing in closed conduits (gas, liquid, water and steam) and open channel (water). The flow computer performs the data processing and displaying function in the flow metering system. The flow computer calculates the volume at line and at base conditions, mass and energy flow rate of the fluid. It totalizes the volume at line and at base conditions, mass and energy for the accounting periods.

The flow computer was designed to provide cost effective solution for multi stream applications. Benefits of the flow computer allowing remarkable cost reduction comparing to the single stream flow computers:

- sharing of the transmitters between metering streams is possible;
- PRT/RTD sensors can be connected directly to the flow computer; no temperature transmitter is required;
- power supply output for transmitters is provided; no separate power supply units required;
- additional I/O modules expand the metering capability of the flow computer with moderated additional cost only;
- flexible communication capabilities allow easy system integration.

The manufacturer Process Control Kft. provides support for the end users to integrate the flow computer into metering systems and into data acquisition and process visualization systems. The manufacturer also can provide complete solution for flow metering task, including the design, manufacturing and implementation if required.

Flow meters that can be selected in the flow computer and the standards related

- pressure differential devices;
 - orifice plate, nozzle, Venturi tube (ISO 5167, edition 1991, 1998 or 2003, GOST 8.563-97, GOST 8.586-2005, AGA3 edition 1990 or 2012)
 - V-Cone meter (according to manufacturer's method);
 - Annubar (according to manufacturer's method);
 - segmental orifice plate;
 - conditioning orifice plate.
- flow meters with linear output signal;
 - turbine meter;
 - Vortex meter;
 - electromagnetic flow meter;
 - ultrasonic flow meter;
 - mass flow meter;
 - volume at base conditions flow meter.
- flow meters with nonlinear output signal;
 - rotameter;
 - flow meter with power characteristic.

Fluids that can be selected in the flow computer together with fluid properties calculation

- hydrocarbon gas mixtures (natural gas, coke oven gas, blast furnace gas);
- pure gases (air, nitrogen, oxygen, argon, carbon-monoxide, ethylene, ammonia, propane, general gas)
- steam and hot water as energy supply fluids;
- liquids (crude oil, refined products, lubricating oil, NGL & LPG, UGC, SHL, WFLH, ethanol, general liquid, liquid mixture);

Standards and procedures for fluid properties calculation

- hydrocarbon mixtures
 - compression factor
 - AGA8 (1985 and 1992) detailed and gross methods; AGA NX19;
 - AGA8 Part 1-2017 (DC, Gross Method 0, Method 1, Method 2, Method 3)
 - AGA8 Part 2-2017
 - GERG88;
 - GOST 30319-96 (GERG91mod, NX19mod, VNIC SMV), GOST 30319-2015.
 - calorific values, relative density and base density
 - ISO 6976 (1995 and 2016), GOST 30319-96, AGA5, GPA 2172-09.
 - dynamic viscosity
 - GOST 30319-96, GOST 30319-2015

- isentropic exponent
 - ISO 20765-1, GOST 30319-96, GOST 30319-2015, AGA8 Part 1-2017, AGA8 Part 2.2017
- velocity of sound
 - ISO 20765-1, GOST 30319-96, GOST 30319-2015, AGA8 Part 1-2017, AGA8 Part 2.2017
- Joule-Thomson coefficient
 - ISO 20765-1, ISO TR 9464, AGA8 Part 1-2017, AGA8 Part 2.2017
- gas composition
 - read on-line from a gas chromatograph,
 - downloaded from a supervisory system,
 - fixed value.
- pure gases
 - compression factor, dynamic viscosity and isentropic exponent
- crude oil and refined products
 - temperature volume correction factors
 - ASTM D1250-80/API 2540 Table 23/24A,B,C, Table 53/54A,B,C
 - MPMS Chapter 11.1-2004 (2007)
 - MPMS Chapter 11.2.4-2007 (Tables 23/24E, 53/54E, 59/60E, GPA TP-27)
 - STO Gazprom 5.9 Annex B.1, B.2, B.3
 - pressure volume correction factors
 - API MPMS Chapter 11.2.1M and 11.2.2M
 - API MPMS Chapter 11.2.1 and 11.2.2
 - STO Gazprom 5.9 Annex B.1, B.2, B.3
- steam and water
 - physical properties
 - Industrial Formulation 1997 for the Thermodynamic Properties of Water and Steam (IAPWS-IF97)
- ethanol
 - physical properties
 - Council Directive 76/766/EEC
 - Horst Bettin, Frank Spieweck: A Revised Formula for the Calculation of Alcoholometric Tables. PTB-Mitteilungen 100 6/90

UNIFLOW-200 is a Gas-volume electronic conversion device complying with EN 12405 and OIML R140.

UNIFLOW-200 is approved as Calculator for Dynamic measuring system for liquids other than water according to OIML R 117-1. UNIFLOW-200 calculates the CO₂ emission for gaseous and liquid fuels according to 601/2012/EU and IPCC 1996.

UNIFLOW-200 is capable to provide flow computer function up to 8 metering streams. In other words: in one UNIFLOW-200 we have 8 independent flow computers.

In general, each metering stream has the input signals as follows:

- flow meter signal
- signals for correction (pressure, temperature, density, gas composition, etc.)

Depending on the application one single signal for correction can be assigned to several metering streams. If here is no transmitter for a particular signal for correction the flow computer will use a fixed value for that signal.

In case of signal failure, the flow computer revert to the fixed value of that signal and this value will be used in the flow calculation.

Beside the 8 physical metering streams the flow computer is capable to provide 4 virtual metering streams. The virtual metering streams are to produce data from the flow rates of the physical metering streams. The virtual streams can be configured to give sum, difference, product or ratio (or their combination) of the physical streams. It can be used to setup a simple energy balance for a small group of consumers.

The accuracy of the flow measurement is a key issue. UNIFLOW-200 high precision inputs, the implementation of the latest editions of the flow metering standards provide minimum contribution of the flow computer in the uncertainty budget of the metering system.

Utilization of the digital communication with the flow meters and transmitters can further reduce the overall uncertainty of the measurement.

3 Technical specification

3.1 General features

- high capacity 32-bits microprocessor
- modular design, up to 5 I/O boards
- up to 8 physical metering streams
- up to 4 virtual metering streams
- flow meters: orifice plate, nozzle, Venturi tube, segmental orifice plate, Annubar, Verabar, Accelabar, V-Cone meter, turbine meter, Vortex meter, ultrasonic meter, electromagnetic meter, mass flow meter, rotameter, meter with power characteristic
- fluids: gas, liquid and water steam
- mode of operation: metering mode, configuration mode, test mode
- configuration: from keypad and via Ethernet link
- password protected parameters, audit trail log
- parameters and totals integrity protection: nonvolatile memory
- archiving: hourly, shift, daily, multi-day and monthly totals and averages for 400 days
- operator interface: alphanumerical and graphical display
- up to 8 RS232/RS485/RS422 serial ports, 10/100 Ethernet and USB interface
- stream independent signal processing
- high reliability, no battery, no potentiometers
- support: **U200ToolBox** configuration and remote archive uploader software

3.2 Technical data

Analog inputs

- symmetrical inputs with galvanic isolation
- input range 0-20 mA / 4-20 mA (operator selectable)
- accuracy +/- 0,02 %
- potential drop on input 5,4 V max. per 20mA(100 Ω + protection)
- equivalent input impedance 270 ohm (100 Ω + protection)
- potential diff. among inputs 50 V max.

PRT/RTD inputs

- sensor type 100 ohms PRT standard (50, 500 or 1000 ohms PRT optional)
- sensor calibration CVD coefficients for individually calibrated sensors accepted
- connection 4-wire
- accuracy +/- 0,03 °C
- maximum loop resistance 3 kohms
- excitation current 1 mA

Pulse/frequency inputs

- Signal type (operator selectable)
 - open collector, potential-free contact - powered from UNIFLOW-200, 12 V/3 mA
 - active signal (externally powered) – square, unipolar
 - 5 V – max. 5 V, signal level change min. 2 V
 - 15 V – max. 15 V, signal level change min. 5 V
 - NAMUR
 - powered from UNIFLOW-200, 8,2 V,
 - input impedance 1 k Ω ,
 - signal level change, min. 1,5 mA.
- frequency range 0...10000 Hz
- signal form square, unipolar
- signal counting without loss of pulses
- Uncertainty of frequency measurement 0.001 % max.

Digital inputs

- potential-free contacts, open collector inputs (transistor) or 24 VDC inputs accepted and used as:
 - static inputs, or
 - pulse inputs (frequency: 100 Hz max., 50 % fill in ratio)
- internal power supply for potential-free inputs: 12 VDC, 6,8 kohm

Analog outputs

- output channels with individual galvanic isolation
- current range 0-20 mA / 4-20 mA (operator selectable)
- resolution 12 bits
- load 500 ohm max.

Digital outputs

- galvanically isolated open collector (transistor), overvoltage- and overcurrent-protected outputs
- type of outputs
 - dual state static signal
 - flow rate limits
 - analog input limits
 - repeating dual state input signal with negation/delay
 - common alarm output
 - pulse signal
 - pulse output proportional to totals
 - time base
 - Max. frequency: 50 Hz,
 - On/off time duration min. 10 msec
- load 100 mA, 40 Vdc max.

High frequency (HF) pulse output

- repeats pulses from one of the selected high frequency pulse inputs (transmitting input pulses to prover computer)
- open collector (transistor), overvoltage- and overcurrent-protected output, 50 mA, 40 V max. (external supply)
- frequency range: 0 ... 10 000 Hz
- pulse repeating without pulse losses

Digital communication

- serial links overvoltage- and overcurrent-protected
 - mode RS232/RS485/RS422 (operator selectable)
 - baud rate 1200...38400 baud (operator selectable)
 - protocol Modbus ASCII and RTU
 - maximum cable length

RS232	15 m
RS485/RS422	1200 m
- 10/100 Ethernet protocol: Modbus TCP

- USB 1.1 port standard-A receptacle, for data saving to flash drive
flash drive shall be formatted for FAT32 file system

Hot/stand-by interface

- flow computer status output (to stand-by unit)
change-over voltage-free contact, maximum load: 100 V, 100 mA
 - operating closed contact (NO)
 - fault opened contact (NC)
- flow computer status input (from hot unit)
potential-free contact, open collector inputs (transistor) or 24 VDC input
 - sense sensing input

Keyboard

- foil protected membrane keyboard

Display

- 3,5" QVGA (320 x 240) backlit TFT color LCD

Performance specification

Maximum Permissible Error (MPE)

- +/- 0,03 % OIML R117, Class 0,3
- +/- 0,2 % EN 12405
- +/- 0,05 % OIML R140

Operating conditions

- operating temperature -10...+60 °C
- operating humidity 10...90 % non-condensing
- EMC complies with EU EMC regulation
- storage temperature -25...+70 °C

Power requirements

- power supply 230 VAC +10 %/-15 %, 50 Hz +/-3 Hz
24 VDC nominal, 20 VDC ... 35 VDC
- power consumption 25 VA max. (depending on the number and type of IO boards fitted)
- transmitter power (output) 1 x 24 Vdc, 200 mA max.

Case and mounting

Panel mounted version

- front panel 196 mm W x 110 mm H
- case depth 272 mm
- minimum cabinet depth 320 mm
- panel cutout 186 mm W x 91 mm H
- weight 4.3 kg
- protection IP20
- prepared for sealing
- plug-in connectors
 - 230 V power supply IEC60320 C14 chassis plug
 - 24 VDC plug-in screw terminal
 - input/output signals 25-pin DSUB connector (female)
 - serial links 9-pin DSUB connector (male)
 - 10/100 ethernet RJ45 UTP
 - USB host and device Standard-A receptacle
 - flow computer status plug-in screw terminal

Protection against electrical shock Class I (EN 61140)

Certificates

- MID certificate (including EMC conformance) issued by: Government Office of the Capital City Budapest, Metrological and Technical Supervisory Department, Section of Mechanical Measurements, Hungary

- for fuel gases (natural gas)
EU type-examination Certificate
TH-8543/8/2021 (EN 12405-1:2005+A2:2010)
TH-8543/5/2018 (EN 12405-1:2005+A2:2010)
- for liquids other than water (crude oil, refined product, lubricating oil, NGL/LPG, alcohol)
Evaluation Certificate
TH-8614/8/2021 (OIML R 117-1:2007 Class 0,3)

3.3 Accessories

List of accessories supplied with UNIFLOW-200

25-pin DSUB connector (male)	1 .. 5*
9-pin DSUB connector (female)	1 .. 3**
230 V power cord (2 meters)	1
Fastener for mounting	4
Fastener screw	4
Fuse	1 set
Instruction manual	1

* Depends on the number of I/O boards fitted

** Depends on the number of serial links fitted

4 Plug-in boards and hardware operation

The modular design of the flow computer allows flexible combination of the I/O boards to suit different applications.

The flow computer consists of the modules as listed below:

- mother board part of the base unit
- front panel with keypad and display part of the base unit
- power supply unit part of the base unit
- CPU board part of the base unit
- I/O boards application dependent
- serial extension module application dependent

The maximum number of I/O boards that can be installed is five. The maximum number of metering streams (8) can be defined only if the total number of input and output channels is covered by the properly selected five I/O boards. Otherwise more than one UNIFLOW-200 should be installed.

The base unit provides communication interfaces as listed below:

- serial link (RS232/RS485/RS422) 1
- USB host 1
- 10/100 Ethernet 1

4.1 Plug-in boards

The available I/O boards listed in the table below:

I/O board name	Number of channels	Signal	Remark
ANI8	8 1	4-20 (0-20) mA current input 24 VDC/200 mA transmitter power	selectable
ANI4PT2	4 2 1	4-20 (0-20) mA current input 100 ohms PRT/RTD input 24 VDC/200 mA transmitter power	selectable 4-wire connection
PT4	4	100 ohms PRT/RTD input	4-wire connection (50, 500, 1000 ohms optional)
PDIO484 (obsolete, replacement type PITC4641)	4 8 4	pulse/frequency input digital (contact) input digital (open collector) output	high level (active or passive) static or pulse static or pulse
AODIO484	4 8 4	4-20 (0-20) mA current output digital (contact) input digital (open collector) output	selectable static or pulse static or pulse
PITC4641	4 6 4 1	pulse/frequency input digital (contact) input digital (open collector) output raw pulse output	high level (active or passive) static or pulse static or pulse repeats selected HF pulse input for prover computer
HTI4x15	32	HART communication input in multidrop or broadcast mode 4 independent loops, 15 PV per loops	The loops are isolated if external power supply is used
Any I/O board can be fit into any I/O slot. Software recognizes the type of the fitted I/O boards automatically.			

Table 4-1 I/O board types

The available communication interfaces listed in the table below:

Communication module	Type	Remark
Com1 port	universal serial port	part of the base unit on the CPU board RS232/RS485/RS422 – selectable
SE module*	serial extension module	additional com2 and com3 ports RS232/RS485/RS422 – selectable Does not occupy I/O board slot.
CX5*	5-channel serial extension board	additional com4 to com 8 ports RS232/RS485/RS422 – selectable Occupy No.5 I/O board slot.
10/100 port	10/100 baseT Ethernet interface	part of the base unit on the CPU board
USB port	USB 1.1 host	part of the base unit on the CPU board
(*) Optional items. None, one of them or both can be installed, depending on the number of ports required. CX5 board can be fit into I/O slot No.5 only.		

Table 4-2 Communication interfaces

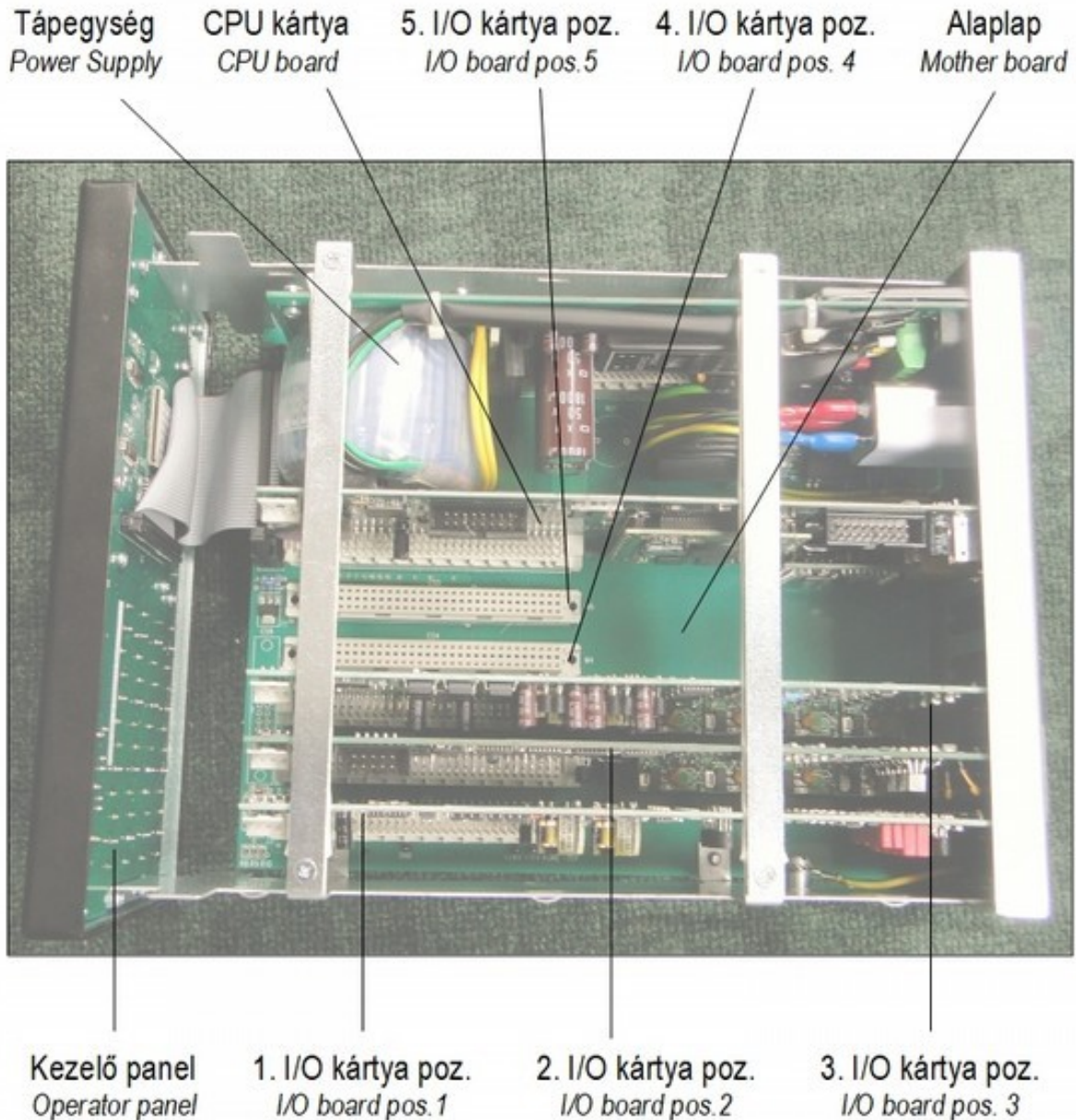

Figure 4-1 I/O board locations

4.2 Hardware operation

The flow computer is built on the basis of the ATMEL ATSAMA5D31 microprocessor.

The application software of the flow computer runs under the UX200 operating system.

The operating system, the application software and the archived data are stored in the Micro SD flash memory, min. 32 GB (PCMCIA device).

All the parameters, calculation data and archive data are stored in flash memory so that the data are retained in case of power failure.

The working memory of the flow computer is 512 MB SDRAM.

The real time clock chip (DALLAS DS3234) provides the time and date for the operation. It provides also 500 ms interrupts for the processor to synchronize the calculation cycles. The clock chip has its own built-in lithium battery providing independent operation from the external power.

The human – machine interface of the flow computer is the 320x240 dots backlit colour LCD and the foil protected membrane keyboard.

There are three LEDs on the front panel.

The POWER LED indicates the presence of power supply.

The RUN LED indicates the normal operation of the flow computer.

The ALARM LED indicates the alarm status.

The Com1 ... Com8 serial ports provide asynchronous communication links to external devices. All of them can be configured as RS23 or RS485 or RS422 port. The parameters of the ports (baud rate, data bits, stop bits, parity) are operator selectable.

The 10/100 BaseT Ethernet port allows to connect the flow computer to the LAN or WAN. The parameters of the Ethernet port (IP address, subnet mask, default gateway) are operator selectable. The Ethernet port can be configured to provide DHCP function.

The USB port is provided for easy transfer of the archive data files to flash drive.

The flow computer can accommodate up to five I/O boards for field signal connection. It is recommended to install the I/O boards in the numbered slots starting from one. The type of the I/O boards is recognized automatically by the CPU board.

The status of the flow computer (normal operation or in error) is signalled with a dual state double pole voltage free contact. The state of the contact and the state of the RUN LED are synchronized. See details in the section [9.3.3](#)

The power supply unit provides two independent groups of voltages for the flow computer operation. The voltages are isolated by DC/DC converters for high noise immunity. The voltages are:

- TTL level voltage
 - +5 V (Vcc) to supply the digital circuits
 - prediction of power failure to provide
 - smooth program stopping and
 - finishing the data saving process
- voltage for analogue circuits
 - +24 V for transmitter power supply
 - +/-15 V to supply the analogue circuits

The I/O boards include also DC/DC converters to isolate the field input signals and the communication interfaces from the internal circuits.

The flow computer can be powered from:

- 230 V 50 Hz or
- 24 V DC

power source. Both power sources can be connected simultaneously. If power exists on both power inputs then the flow computer takes power from the 230 V 50 Hz inputs. If the power fails on this input then the flow computer automatically switch to the 24 VDC power input. The power switch over will not affect the operation of the flow computer.

To assure high reliability and low maintenance no potentiometers and no batteries are installed in the flow computer.

5 Installation, wiring and start-up

UNIFLOW-200 flow computer is designed for panel mounting. Its outer case is made of painted welded steel list to provide magnetic screening.

The mechanical structure of the flow computer is constructed in such a way that after loosening the two fixing screws on the back side of the unit the complete internal can be pulled out from the front. The terminals and the sockets for the signal connections and the fuse holders are located on the backplane of the unit.

The base unit consists of 4 PCBs, the mother board, the front panel, the power supply and the CPU. The front panel connects to the mother board with flat ribbon cable. The CPU board and the power supply are connected to the mother board with multi-pin sockets. There are 5 off 64-pin sockets on the mother board to accommodate the I/O boards for field signals. The field signals are connected to the 25-pin DSUB sockets located at the rear edge of the I/O boards.

5.1 Installation

Installation of the UNIFLOW-200 must conform to all applicable local codes and regulations. All installation procedures should be in accordance with normal practices of good workmanship.

The UNIFLOW-200 panel mount is designed for use within the control room and should be placed in a position that provides ease of use, comfort, and safety for operators and maintenance personnel. The optimum height for viewing and using the display and keypad is at operator eye level.

CAUTION

Where one or more units are installed in a confined space or with other heat producing equipment, special attention should be given to the combined heating effect. This combined heat could increase the environmental temperature beyond its acceptable threshold impacting performance.

Prepare the requested cut out in the panel for mounting. Refer to the drawing in the Annex B. Panel thickness should be at least 3 mm to prevent distortion.

Carefully slide the UNIFLOW-200 into the cut out. Secure the unit in the panel by means of the four fasteners supplied with the unit.

5.2 Wiring

All local wiring practices and regulations should be observed performing the wiring.

The connectors and terminals accepting external wiring are located on the backplane of the flow computer as shown on the figure below.

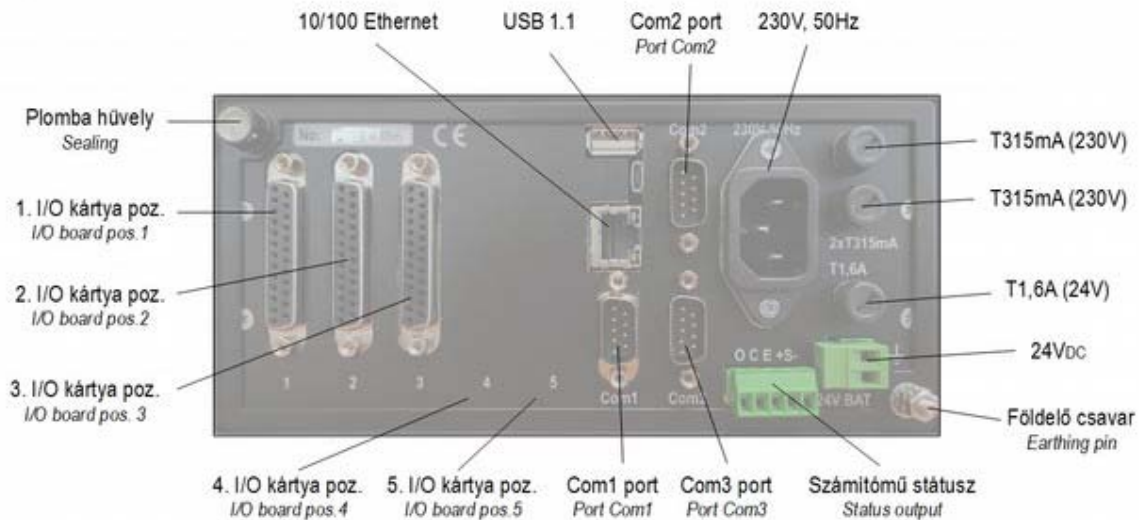

Figure 5-2 Backplane connectors

Power supply

Two different power supply inputs are available on the UNIFLOW-200. Both power supply input can be connected at the same time.

230 V 50 Hz power supply is connected via IEC60320 C14 chassis plug.

CAUTION

UNIFLOW-200 shall be connected to the power supply system with protective ground.

24 VDC power supply connection is made by a plug-in screw terminal. The terminal is labeled 24 V BAT.

Serial ports

Three communication ports are provided on the backplane of the flow computer.

The ports use 9-pin DSUB male connectors and are labeled COM1, COM2 and COM3.

The pin assignments of the connectors in case of RS232/RS485/RS422 configuration see in the Appendix B.

Ethernet port

This port is for high-speed communications using Ethernet local area network architecture.

The speed of data transfer is 10/100 Mb/sec using a 10baseT twisted pair. The port uses an RJ45 connector.

USB port

USB port is for file transfer from the flow computer to flash drive device. The port uses a standard-A receptacle.

Status output and Sense input

A single pole, double throw relay with Normally Open or Normally Closed terminals provides the status (operating and error) of the flow computer. A flow computer failure causes the relay to de-energize. Connection is made by plug-in screw terminals. Contact is rated at 100 mA, 100 volts and is a Form "C" contact.

The terminals are marked:

O	operating
C	common
E	fault

The Sense input accepts potential-free contact, open collector inputs (transistor) or 24 VDC input from other flow computer working in pair in hot/stand-by mode.

The terminals are marked:

+S	+ signal
S-	- signal

I/O board connectors

The backplane has one 25-pin female D-type connectors for field wiring for each I/O board.

See the pin assignment of the connector for each type of the boards in the Annex B

5.3 Start-up

After the UNIFLOW-200 has been wired for power and external devices, it may be activated by energizing the external power supply. When power is applied, the unit displays the message **Load in progress... Please be patient.**

After about 1 minute the operating system of the unit starts testing the internal parameters and displays messages indicating whether the parameters pass or fail the test. If some of the parameters are missed or damaged the default parameters are activated.

After the tests the blinking message **Restarted!** appears on the display together with the date and time of the restart and with the current date and time.

There is also a message informing operator if the test of parameters was successful or the test failed and default parameters were activated.

After pressing any key the main menu appears on the display.

If after the start-up the unit displays messages **Parameters are damaged!** and **Check parameters!** then it is necessary to enter the Parameters menu and set the parameters required for the particular application. Before setting up the proper parameters the unit will not start the normal operation, i.e. will not start to perform the measurement.

See the setup procedure in the Section 9.

If after the start-up the unit displays messages **Parameters are OK!** then it starts the normal operation, i.e. it will perform the measurement even if the blinking message **Restarted!** is seen on the display.

CAUTION

If the operating conditions and the parameters of the application were not provided to the manufacturer then UNIFLOW-200 is supplied from the factory with all the input and output channels inactive and all the metering streams are disabled.

It is part of the start-up procedure to setup the unit for the particular application. See the setup procedure in the Section 9.

5.4 Start and stop metering streams

Once the metering stream is properly configured it starts the flow calculation and never stops.

When operator modifies any parameter and leaves the Parameters menu the flow calculation is interrupted for few calculation periods while the new parameters are checked.

The metering stream operation can be suspended if in the parameter setup the fluid or the flow meter set to None (see section 9).

6 Basic operation

The operation of the UNIFLOW-200 is accomplished through an operator interface comprising an LCD display and a keypad. The layout of the front panel is shown in figure below.

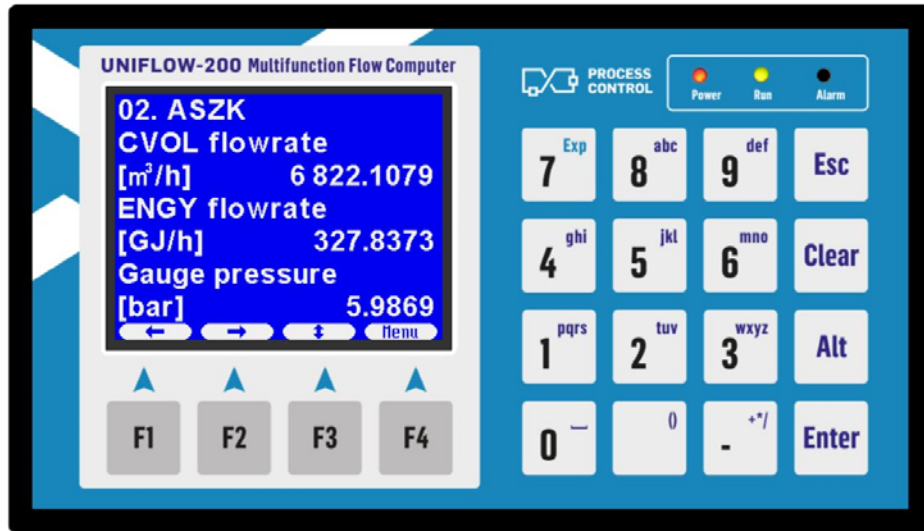

Figure 6-3 Front panel

6.1 Keypad

There are 20 keys located on the keypad grouped into 3 functional groups.

6.1.1 Numeric keys

The numeric keys offer the full number set (0 - 9), decimal point (.), and a minus (-) key. They used to enter or change data.

Each numeric key has secondary characters assigned to them.

They are as follows:

Numeric 1 to 8 – alphabetic letters from A to Z and from А to Я (Cyrillic letters)

Numeric 0 – space ()

Numeric 7 – Exponent (Exp)

Decimal point (.) – opening (()) and closing ()) bracket

Minus sign (-) – plus (+), multiply (*) and divide (/) sign

The secondary characters activated by repeated key press.

For example, pressing the key 9 repeatedly the characters in the input field appears in the following order: 9 D E F É d e f é Д Е Ж 3 д е ж 3. Both uppercase and lowercase letters can be entered this way.

Letters and special characters are used to

- enter text information (e. g. the name of the metering stream)
- enter equation in virtual stream definition (see Section 9.)

Exponent key is used to enter quantities in scientific notation. The exponent field is activated by pressing Alt key then Exp key. Letter “e” appears in the input field indicating that the exponent part of the number to be entered.

Exponent key available only for the parameters which value in decimal notation exceeds the space available in the input fields.

6.1.2 Editing keys

Esc key

- pressing Esc key while editing any data entry field causes the editing stopped, the entered numbers or the selection mode is ignored and the original value of the field is restored;

- pressing Esc key while data page is displayed (and no any data entry field is being edited) causes exit from data page to the parent menu. All the modifications done after the last pressing of the Save key will be ignored and the original values of the data fields will be restored.

Clear key

- pressing Clear key while editing any data entry field causes the last character entered is cleared.

Alt key

- Alt key is used in conjunction with the Exp key to enter number in exponential format.

Enter key

- Enter key is used to finish the data entry and data selection in the data entry fields. Pressing Enter do not causes the entered data is activated. To activate the data the Save key shall be pressed and the Parameters menu item shall be left. Exiting from parameter menu the flow computer shows message Parameter update in progress. The modified parameters will be used in flow calculation after the message disappears.

6.1.3 Function keys

There are four function keys located below the display and marked with F1, F2, F3 and F4.

The function keys have no one single particular function. They are multi-functional keys. The valid functions of the keys at each particular display page are indicated in the bottom line of the display.

The function keys are to navigate in the menu tree and select parameters or data items to view, change or save.

The functions of the keys are as follows:

⇐ left arrow

- move to the previous (upper) level of menu tree or return to the parent menu from the data page

⇒ right arrow

- move to the next (lower) level of menu tree
- enter into data page if there is no more menu tree level

↑ up arrow

- move by one item up in the menu list (on the menu page) or data list (on data page)

↓ down arrow

- move by one item down in the menu list (on the menu page) or data list (on data page)

⇅ up-down arrow

- scroll through the menu items or data pages. After the last menu item or data page the first one appears.

↔ left-right arrow

- move to the next data entry field. After the last field the cursor jumps to the first field.

Save

- save the data on the data page displayed and return to the parent menu

Change

- in the numeric entry field: clears the content of the field and enters the field for editing
- in the selection entry field: pressing Change key repeatedly the option list for the selection scrolls in the selection field. Press Enter when the desired option is displayed to make your selection.

Menu

- leaves the data page and return to the parent menu

OK

- confirm the selection of the highlighted item

6.2 Display

The 320 x 240 dots backlit TFT color LCD display offers 14 lines of information displayed as alphanumeric and graphical characters.

There are two different types of display pages available in the UNIFLOW-200:

- menu page
 The left pane of the menu page shows the menu tree levels the operator went through to arrive to the current position. The right pane shows the available menu items for selection. Press \uparrow and \downarrow key to highlight the desired menu item. Press \Rightarrow key to enter the next menu level or to data page. Press \Leftarrow to return the previous menu level. The figure below shows an example of the menu page

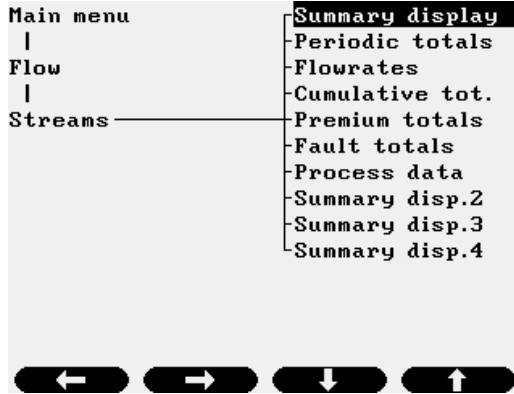

Figure 6-4 Menu page

- data page
 The data page is a list of parameters. The description, the value and the unit of measurement of the parameters are shown. Press \uparrow and \downarrow key to highlight the desired data item. Press Change key to start editing the numeric entry field. Press Change key repeatedly to scroll through the available options of the selection entry field. Press OK key to confirm the numeric value entered or the selection highlighted. Press Save key to save the new value of the parameter and return to the parent menu. Press Esc key if you want to discard the editing you have done and return to the parent menu. The figure below shows an example of the data page.

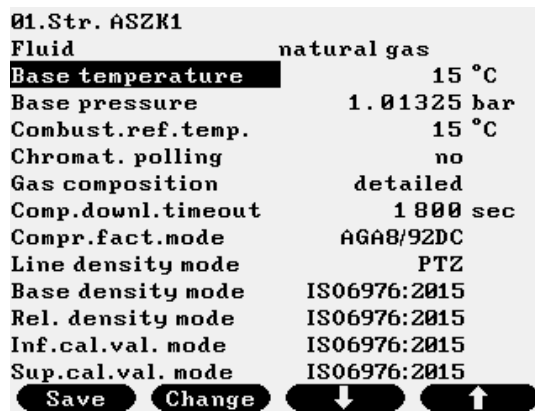

Figure 6-5 Data page

NOTE

Each page consists of 15 lines.
 First line shows the stream identifier string.
 Last line shows the function pictogram of the F1 - F4 function keys.
 13 data lines can be seen on the screen. If more than 13 data items to be displayed scroll through the data lines with \uparrow and \downarrow keys.

6.2.1 Navigating the display

From the main menu select the item you require by pressing \uparrow and \downarrow keys. Press \Rightarrow key to enter the next menu level. Select the required sub-menu item by pressing \uparrow and \downarrow keys and press \Rightarrow key to enter the next sub-menu level. Repeating this procedure, you arrive to the required data page. Navigating in the menu tree you can see the menu and sub-menu items passed on the left pane of the display.

Pressing \Leftarrow key returns to the previous menu level.

6.3 Data security

6.3.1 Hardware write lock switch

Flow computer has a hardware write lock switch.

The write lock switch located on the base plate as shown on the picture below.

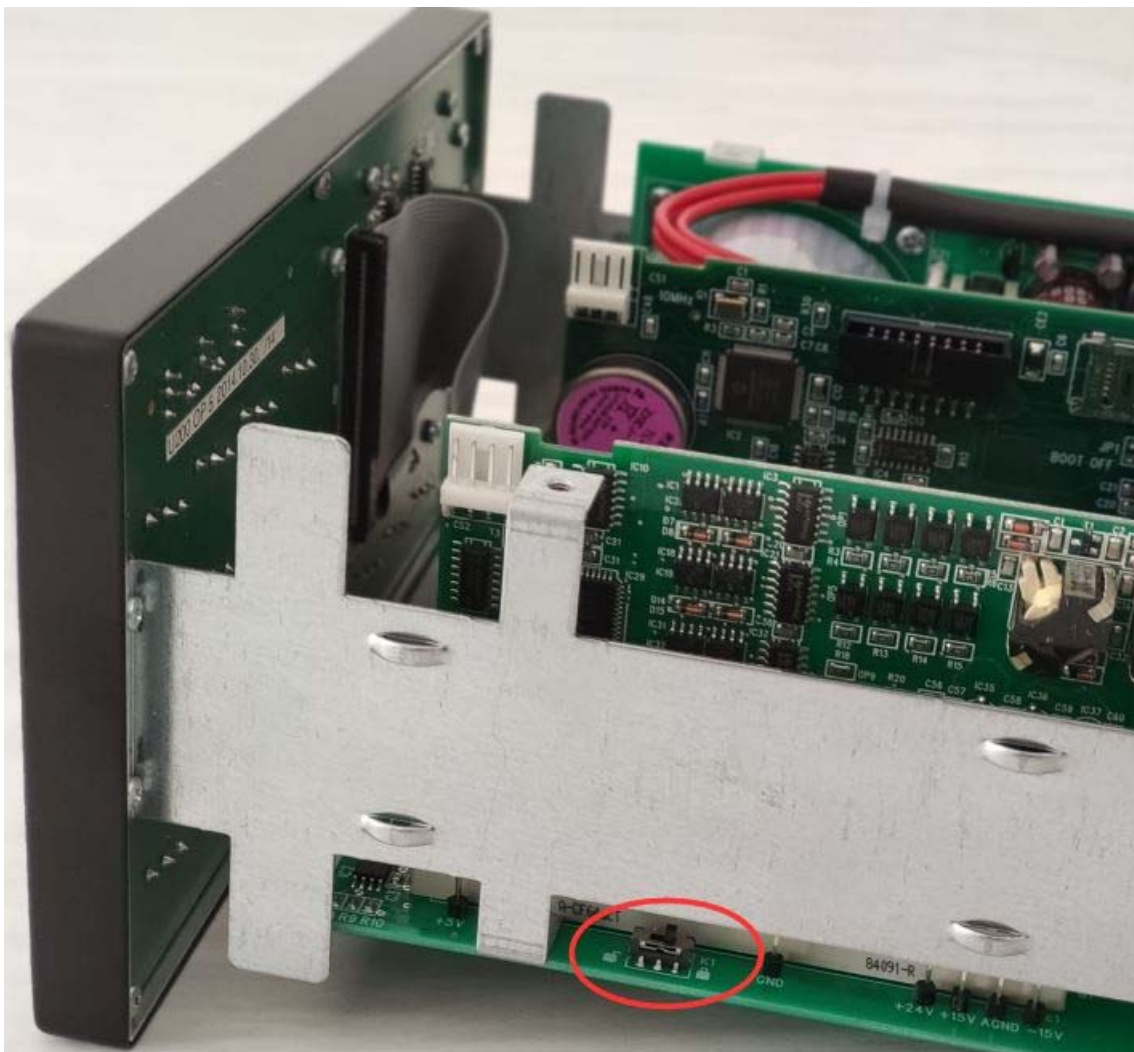



Figure 6-6 Hardware write lock switch

The write lock switch is accessible after pulling out the display from the housing together with the internal frame holding the PCBs. The housing is fixed to the internal frame by means of 2 screws on the back of the unit. Under one of the screws sealing cup is mounted. After fixing the screw the cup is filled with sealing wax (picein) and marked with the stamp of organization (authority) responsible for sealing the unit.

If the unit is sealed the write lock is accessible only after breaking the seal.

The write lock switch has two positions:

 OFF (open, inactive)

 ON (closed, active)

In open position there is no restriction on the firmware update and parameter download or modification. In closed position firmware update is not allowed, parameter project download is not allowed and parameter modification is not allowed. The parameters still can be checked on the display, like at Guest software security level and can be uploaded from the flow computer.

The status of the write lock switch can be checked on the display shown below.

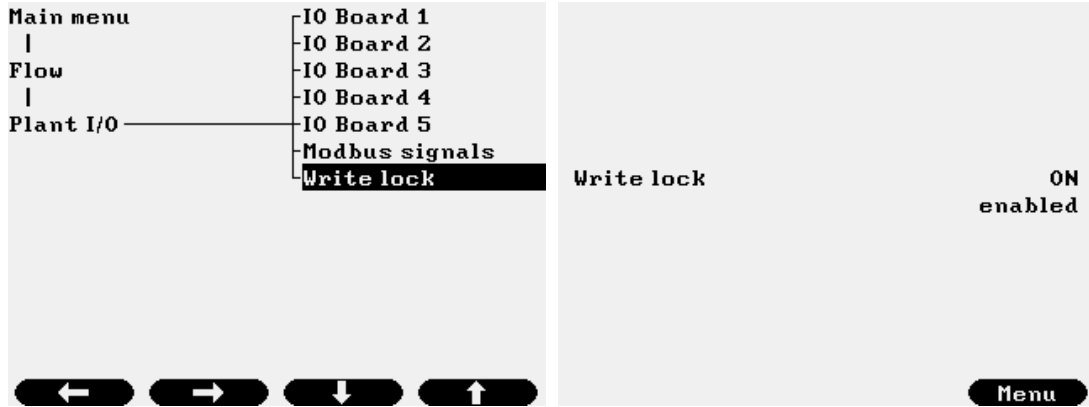

Figure 6-7 Write lock switch status

Entering Parameters menu with write lock active, message will appear on the display as shown below, warning the operator about the active write lock.

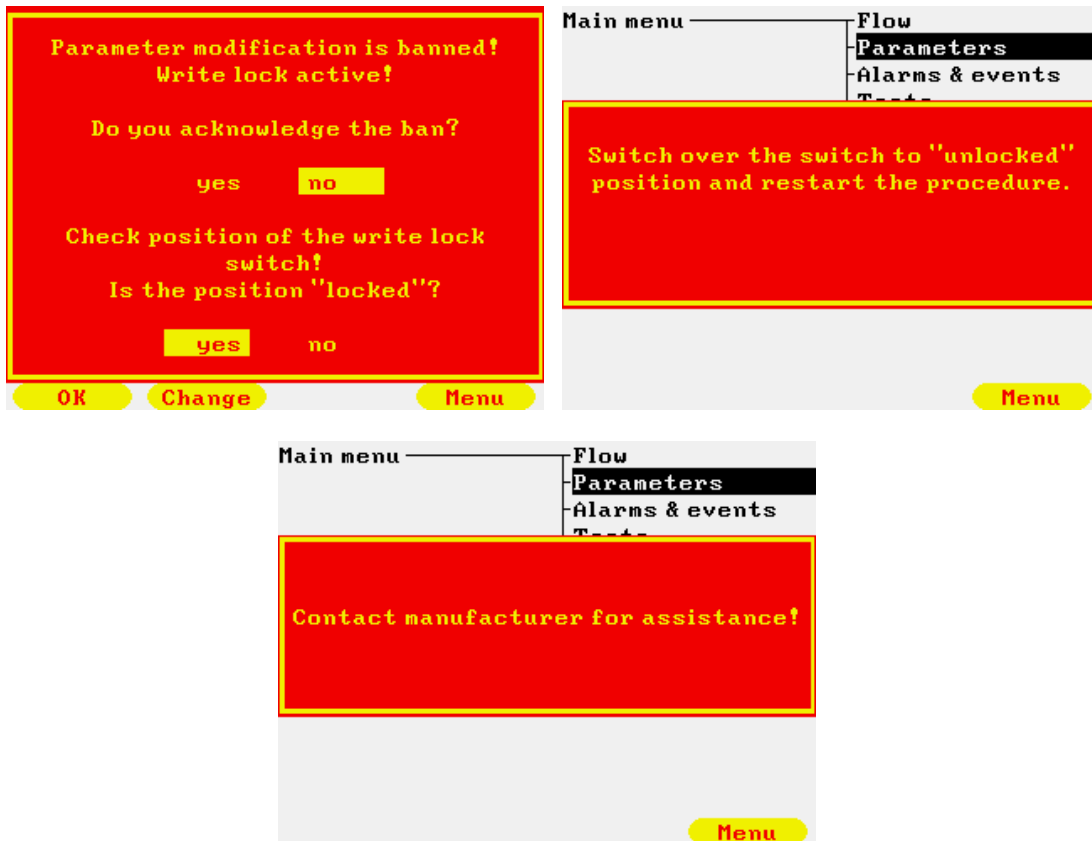

Figure 6-8 Write lock message on display

If the operator does not accept the restriction the position of the switch shall be checked.

If the write lock switch is in locked position, it shall be switched to unlock position. Modification of the parameters will be allowed after that.

If the write lock switch is in unlocked position, but the flow computer reports restriction then the manufacturer shall be contacted for assistance.

Trying to update the firmware or download parameter project via the ToolBox software warning message will appear on the ToolBox screen and the update or download will not happen.

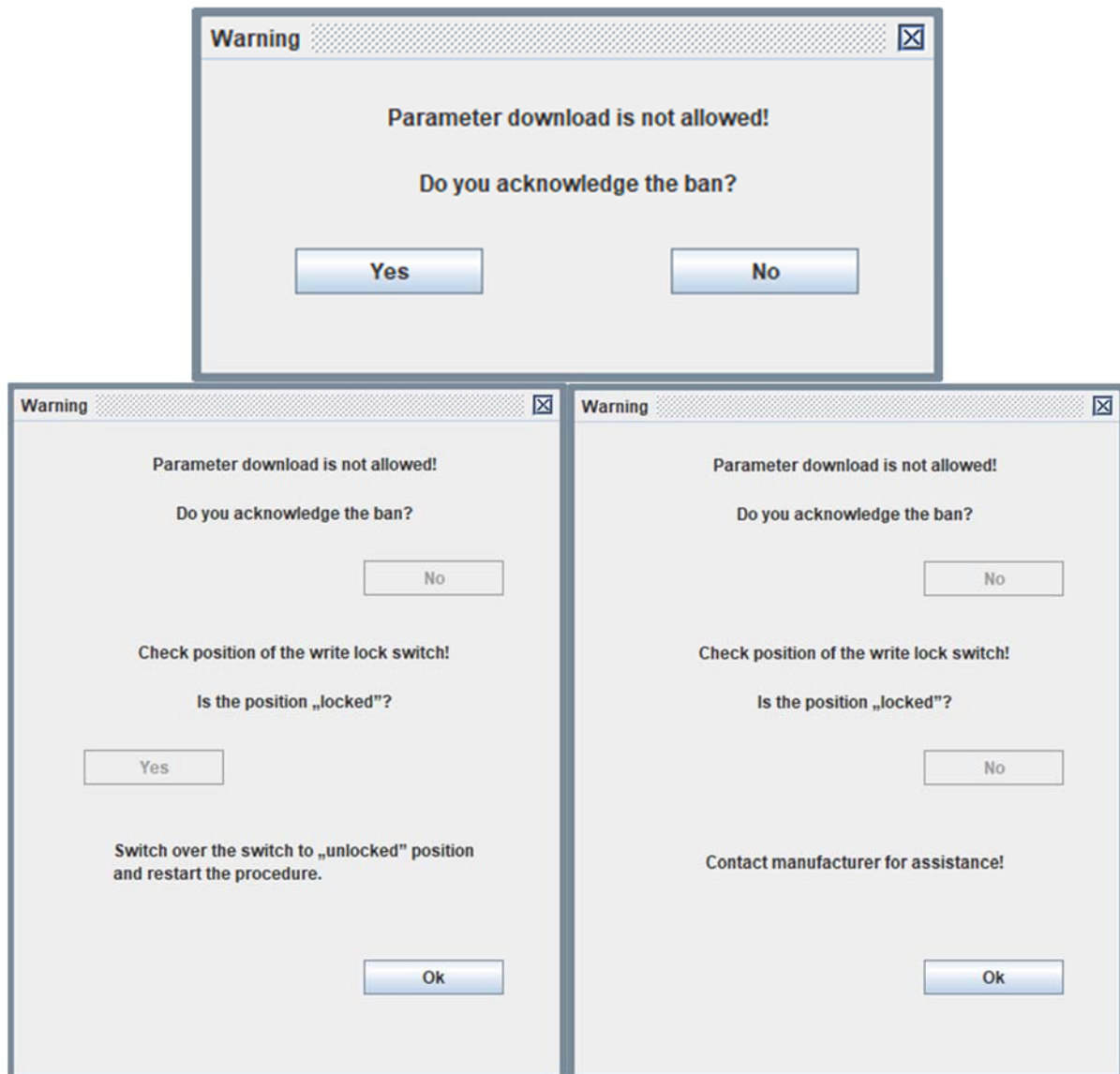

Figure 6-9 Write lock message on ToolBox

6.3.2 Enabling write lock switch

The flow computer is supplied from the factory with write lock switch disabled by default. The status will be as can be seen on the picture below-.

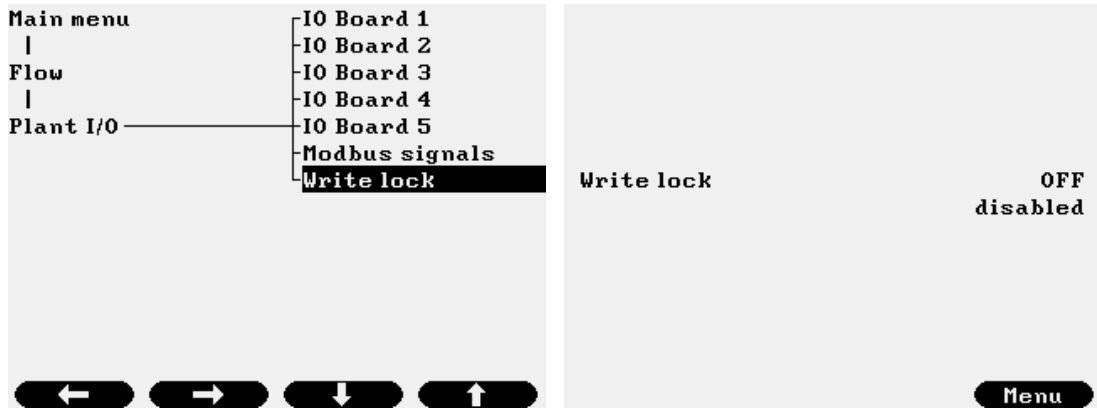
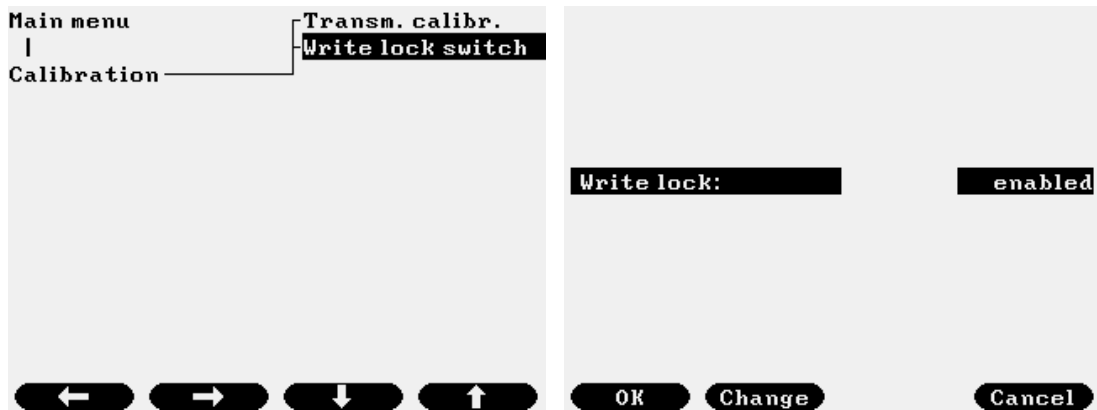

Figure 6-10 Write lock switch status by default

The write lock switch shall be enabled before it performs the function described in par. 6.3.1. To enable write lock switch navigate to the page Calibration/Write lock switch



Write lock switch will be enabled. The write lock switch cannot be disabled once is it enabled.
 UNIFLOW-200 will be write protected when the write lock switch is in ON position and will not be write protected when the write lock switch is in OFF position.

Do you want to enable the switch? yes
 Are you sure to enable the switch? yes

OK Change Cancel

Figure 6-11 Enabling write lock switch

Change the status to enabled by clicking Change button and press OK. Warning message will be displayed. After you confirm twice your intention to enable the write lock switch it will be enabled. Caution! Once the write lock switch enabled it cannot be disabled.

6.3.3 Software security levels

If the hardware write lock is open the data are still protected with password in the flow computer. There are three security levels. Each of them has its own password. Depending on the security level the operator logged in he/she has the right to modify different groups of parameters.

At Engineer level both the Operator and Engineer password can be modified.

CAUTION

The flow computer shipped with empty password list. It means that pressing Enter when the flow computer requires password you log in at Engineering level allowing modification all the parameters.

Set your own Operator and Engineering level password to protect the parameters against undesired modification. The procedure for password setting is described in Section 9.

Remember the password you entered. If you forget your password you will have to ask the assistance of the manufacturer or you have to return the unit to the manufacturer.

Guest level

At Guest level all the parameters can be reviewed at the display but no any modification is allowed.

The default password for Guest level is the Enter key. When the flow computer prompt for the password just press Enter key without entering any codes.

The Guest level password cannot be altered.

Operator level

At Operator level only the parameters listed in the Operator parameters submenu are available for modification. These parameters include the transmitter ranges, the high and low alarm limits and the keypad values.

The default password for the Operator level is Enter (no password is set).

Engineer level

At Engineer level all the parameters are available for editing.

The default password for the Engineer level is Enter (no password is set).

IMPORTANT

Once the operator logged in at Operator or Engineer level and the inactivity period (i. e. no any key is pressed) exceeds 2 minutes the flow computer automatically logs out the operator. This is to prevent accidental leaving the flow computer in the state where the parameters can be altered.

6.4 The menu system

The main menu consists of items as shown below.



Figure 6-12 Main menu page

The menu items Flow, Alarms & events, Help and language selection (Magyar/English/Русский/Română) are accessible without password.

In Flow menu the metering data are shown grouped into different submenus.

In Alarms & events menu, the list of unacknowledged and acknowledged alarms can be seen. The alarm log, event log and the downloaded gas composition log are accessible here also.

The menu items Parameters and Tests require password to enter for accessing.

The menu item Calibration is reserved for the manufacturer and for the authority calibrating the flow computer. It is accessible with special password only.

The menu item Language allows selecting the language the flow computer communicates with. Available languages are Magyar (Hungarian), English, Русский (Russian), Român (Romanian). Changing the language will change the language of the display, the alarm messages, etc. UNIFLOW-200 is a true multilingual flow computer.

The menu structure (the menu tree) shown on the figures below.

Main menu	Submenu 1	Submenu 2	Submenu 3	Submenu 4	
Flow	Streams	Summary display	data page (1.1.1)		
		Periodic totals	data page (1.1.2)		
		Flowrates	data page (1.1.3)		
		Cumulative totals	data page (1.1.4)		
		Premium totals	data page (1.1.5)		
		Fault totals	data page (1.1.6)		
		Process data	Flow meter data		data page (1.1.7.1)
			Fluid data		data page (1.1.7.2)
				(*)	
			Summary display 2	data page (1.1.8)	
		Summary display 3	data page (1.1.9)		
		Summary display 4	data page (1.1.10)		
	Plant I/O	I/O board 1	data page (1.2.1)		
		I/O board 2	data page (1.2.2)		
		I/O board 3	data page (1.2.3)		
		I/O board 4	data page (1.2.4)		
		I/O board 5	data page (1.2.5)		
		Modbus signals	data page (1.2.6)		
	Archive data	Archived periodic totals	data page (1.3.1)		
		Archived batch totals	data page (1.3.2)		
Modbus regs	data page (1.4)				
Data transfer	data page (1.5)				
Extra sum. display	Extra sum. disp. 1	data page (1.6.1)			
	Extra sum. disp. 2	data page (1.6.2)			
	Extra sum. large. 1	data page (1.6.3)			
	Extra sum. large 2	data page (1.6.4)			
Batches	Tank loading	data page (1.7.1)			
	Pipeline interface	data page (1.7.2)			
Meter serial test	data page (1.8)				
PID	PID1	data page (1.9.1)(**)			
	PID2	PIC control loop	data page (1.9.2.1)(***)		
		FIC control loop	data page (1.9.2.2)(***)		
	...				
	PID8				

(*) Depending on the selected flow meter and the fluid more data pages may exist.

(**) In case of single loop

(***) In case of dual loop

Figure 6-13 Main menu – Flow

Main menu – Parameters

Main menu	Submenu 1	Submenu 2	Submenu 3	Submenu 4
Parameters	IO signals	IO board 1	1. channel	data page (2.1.1.1)
			2. channel	data page (2.1.1.2)
			(*)	
			n. channel	data page (2.1.1.n)
		IO board 2	1. channel	data page (2.2.1.1)
			2. channel	data page (2.2.1.2)
			(*)	
			n. channel	data page (2.2.1.n)
		IO board 3	1. channel	data page (2.3.1.1)
			2. channel	data page (2.3.1.2)
			(*)	
			n. channel	data page (2.3.1.n)
		IO board 4	1. channel	data page (2.4.1.1)
			2. channel	data page (2.4.1.2)
			(*)	
			n. channel	data page (2.4.1.n)
		IO board 5	1. channel	data page (2.5.1.1)
			2. channel	data page (2.5.1.2)
			(*)	
			n. channel	data page (2.5.1.n)
		Modbus signal	1. channel	data page (2.6.1.1)
			2. channel	data page (2.6.1.2)
			(*)	
			n. channel	data page (2.6.1.n)

(Main menu - Parameters continued)

Main menu	Submenu 1	Submenu 4	Submenu 5	Submenu 6	Submenu 7
Parameters	Streams				
	Submenu 2				
	Physical stream				
	Submenu 3				
	Stream 1.				
		Fluid	Fuel gases	Natural gas	data page (2.2.1.n.1.1.1)
				Coke oven gas	data page (2.2.1.n.1.1.2)
				Blast furnace gas	data page (2.2.1.n.1.1.3)
			Pure gases	Air	data page (2.2.1.n.1.2.1)
				Nitrogen	data page (2.2.1.n.1.2.2)
				Oxygen	data page (2.2.1.n.1.2.3)
				Argon	data page (2.2.1.n.1.2.4)
				Carbon-dioxide	data page (2.2.1.n.1.2.5)
				Hydrogen	data page (2.2.1.n.1.2.6)
				Carbon-monoxide	data page (2.2.1.n.1.2.7)
				Ethylen	data page (2.2.1.n.1.2.8)
				Ammonia	data page (2.2.1.n.1.2.9)
				Propane	data page (2.2.1.n.1.2.10)
				General gas	data page (2.2.1.n.1.2.11)
			Water steam	data page (2.2.1.n.1.3)	
			Water	data page (2.2.1.n.1.4)	
			Liquid	Crude oil & product	data page (2.2.1.n.1.5.1)
				Ethanol	data page (2.2.1.n.1.5.2)
				General liquid	data page (2.2.1.n.1.5.3)
				Liquid mixture	data page (2.2.1.n.1.5.4)
			None		
			Electric power		
		Flow meter	Diff. press. dev.	Orifice plate	data page (2.2.1.n.2.1.1)
				Nozzle	data page (2.2.1.n.2.1.2)
				Venturi tube	data page (2.2.1.n.2.1.3)
				Segm. orif. plate	data page (2.2.1.n.2.1.4)
				V-Cone meter	data page (2.2.1.n.2.1.5)
				Compact orifice	data page (2.2.1.n.2.1.6)
			Annubar	Annubar	data page (2.2.1.n.2.2.1)
				Verabar	data page (2.2.1.n.2.2.2)
				Accelabar	data page (2.2.1.n.2.2.3)
			Turbine meter	Gas turbine	data page (2.2.1.n.2.3.1)
				Liquid turbine	data page (2.2.1.n.2.3.2)
			Vortex meter	data page (2.2.1.n.2.4)	
			Mass flow meter	data page (2.2.1.n.2.5)	
			Ultrasonic meter	data page (2.2.1.n.2.6)	
			Rotameter	data page (2.2.1.n.2.7)	
			El. magnet. meter	data page (2.2.1.n.2.8)	
			CVOL flow meter	data page (2.2.1.n.2.9)	
			Power char. meter	data page (2.2.1.n.2.10)	
			None		
			Electric power meter		
			Stream	data page (2.2.1.n.2.13)	
		Stream setup	data page (2.2.1.n.3)		
		Premium limits	data page (2.2.1.n.4)		
		Limits	data page (2.2.1.n.5)		
	Stream 2., ...8. (**)				

(Main menu - Parameters continued)

Main menu	Submenu 1	Submenu 2	Submenu 3	Submenu 4	Submenu 5
Parameters		Virtual stream	Stream 9	Stream setup	data page (2.2.2.m.1)
				Premium limits	data page (2.2.2.m.1)
				Limits	data page (2.2.2.m.1)
			Stream 10., 12. (**)		
		Prem. mode setup	data page (2.2.3)		
		Fault mode setup	data page (2.2.4)		
		Barometric pressure	data page (2.2.5)		
		Averaging	data page (2.2.6)		
		Totals format	data page (2.2.7)		
	General data	Date/time	data page (2.3.1)		
		Timezone	data page (2.3.2)		
		Period settings	data page (2.3.3)		
		User defined	Display	Summary display	data page (2.3.3.1.1)
				Extra sum. display	data page (2.3.3.1.2)
			Reports	data page (2.3.3.2)	
				data page (2.3.3.3)	
		Password	data page (2.3.4)		
		Reset	Totals reset	data page (2.3.5.1)	
			General reset	data page (2.3.5.2)	
		Version control	data page (2.3.6)		
		Company data	data page (2.3.7)		
		LCD settings	data page (2.3.8)		
		Character type	data page (2.3.9)		
	Interfaces	Serial ports	Serial port 1	data page (2.4.1.1)	
			Serial port 2	data page (2.4.1.2)	
			Serial port 3	data page (2.4.1.3)	
			Serial port 4****	data page (2.4.1.4)	
			Serial port 5****	data page (2.4.1.5)	
			Serial port 6****	data page (2.4.1.6)	
			Serial port 7****	data page (2.4.1.7)	
			Serial port 8****	data page (2.4.1.8)	
		Ethernet port	data page (2.4.2)		
		USB			
	Operator params.	Keypad & limits	data page (2.5.1)		
		Keypad values	data page (2.5.2)		
	Restore	Parameter project	data page (2.6.1)		
		Firmware	data page (2.6.2)		

(*) The number of channels depends on the type of the I/O board installed. See chapter 4 for details.

(**) Submenus for Stream 2, 3, ..., 8 are identical with those of Stream 1

(***) Submenus for virtual streams 10, 11, 12 are identical with those for Stream 9

(****) Appears only if CX5 serial extension board is installed

Figure 6-14 Main menu - Parameters

(Main menu continued)

Main menu	Submenu 1	Submenu 2	Submenu 3	
Alarms & events	Not acknowledged	data page (3.1)		
	Acknowledged	data page (3.2)		
	Events	Alarm log	data page (3.3.1)	
		Event log	data page (3.3.2)	
		Downloaded log	data page (3.3.3)	
Premium report		data page (3.3.4)		
Tests	IO board 1	data page (4.1)		
	IO board 2	data page (4.2)		
	IO board 3	data page (4.3)		
	IO board 4	data page (4.4)		
	IO board 5	data page (4.5)		
	IO polling	data page (4.6)		
	Modbus regs	data page (4.7)		
	IO polling	data page (4.8)		
Calibration				
Help	data page (6)			
Language	data page (7)			

Figure 6-15 Main menu – Alarm and events, Tests, Calibration, Help, Language

6.5 Entering data

There are two different data types in the UNIFLOW-200.

Numeric data can have any numeric value the operators enter (within the limit of the applicable standard).

An example of such value is the orifice bore diameter.

Selection data can have value selected from a list of options.

An example of such value is the differential pressure tapping location of the orifice meter. It can be selected from a list comprising corner, flange or D and D/2 tapping.

Changing the value of numeric data or selection of any displayed parameter is straightforward with the UNIFLOW-200.

6.5.1 Changing numeric data

Locate the parameter to be changed in the Parameters menu navigating to the appropriate data page. Entering into Parameters menu key in the password corresponding to the security level the desired parameter can be changed.

Select the parameter on the data page using \uparrow and \downarrow keys.

Press Change key and enter the new value. If necessary, you can edit the new data as you key it in. Use Clear key if you want to delete single figures or characters.

Press OK function key or Enter key to finish editing and accept the entered figures.

Pressing Esc key while editing causes the data entry process aborted and the original value of the parameter is restored.

Select the next parameter to be edited and repeat the procedure above.

When you finish the data editing on the data page press the Save function key to make your modification permanent. Pressing Save key saves the modified parameters and return to the parent menu from the data page.

If instead of Save key you press Esc key all the modification done on the data page are discarded. It causes the original values of the parameters are restored and return to parent menu.

6.5.2 Changing selection

Changing the selection is done in a similar way as changing the numeric data.

The only difference is that the list of available options for selection is scrolled through in the data entry field by pressing Change key repeatedly.

6.6 Data pages

The data pages are listed in the Section 9.

7 Maintenance and troubleshooting

In normal operating environment UNIFLOW-200 do not require any periodic maintenance. However, the real time IC (Dallas 12887) shall be replaced after 10 years of operation.

If the UNIFLOW-200 fails to start check the fuses.

There are three fuses located on the rear panel of the flow computer as shown on the figure below.

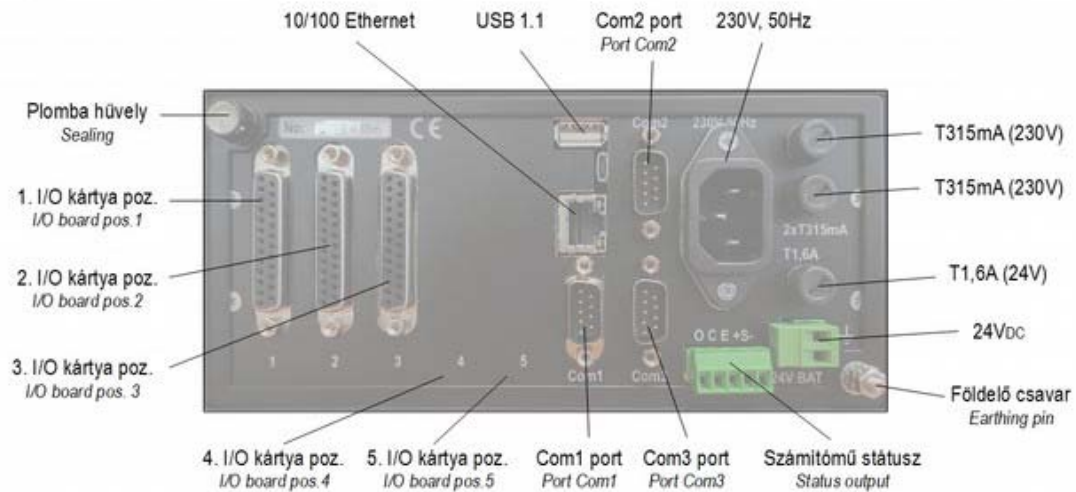

Figure 7-16 Fuses

Fuse F1 (T type 1.6 A) protects the 24 VDC power input.

Fuses F2 and F3 (T type 315 mA) protects the 230 V 50 Hz power input.

CAUTION

Disconnect both 230 V 50 Hz and 24 VDC power inputs before the fuse replacement.

Never use fuses with higher rating than it is recommended. It may cause damage of the instrument.

The signal on the input and output channels can be checked in the menu:

Main menu – Tests – I/O board n ,

where n is the number of I/O board to be tested.

The data page of the I/O boards shows:

- current in mA for current input and current output channels;
- resistance for PRT/RTD channels;
- frequency and number of pulses received for pulse input channels;
- state (open or closed) for digital input and digital output channels.

8 Support

For convenience of operation software tool is available for UNIFLOW-200.

8.1 U200ToolBox

It is a Java based application running on PC consists of three tools.

8.1.1 UNISetup

General features of the UNISetup

- connects to UNIFLOW-200 on the Ethernet port;
- uploads application parameters from UNIFLOW-200;
- generates application parameters off-line;
- edits application parameters off-line;
- saves application parameters on the disk drive of the PC;
- downloads application parameters to UNIFLOW-200.

8.1.2 UNIArchive

General features of the UNIArchive

- connects to UNIFLOW-200 on the Ethernet port;
- uploads archive data files from UNIFLOW-200;
- saves archive data file on the disk drive of the PC.

8.1.3 UNIUpdate

- updates the firmware of UNIFLOW-200;
- update file and download code supplied by manufacturer.

See installation and operating instruction of the U200ToolBox in the help file of the software.

U200ToolBox is available for download on the web site of manufacturer, www.processcontrol.hu.

9 Detailed operation – The menu tree

In this section, the data pages are described in detail. The order of data pages follows the menu structure.

9.1 Flow

In the Flow menu, the measured and calculated data can be called on the display. The data are grouped together on several submenu pages as described below.

No password is required to enter the Flow menu and to display any data.

No data modification can be initiated in the Flow menu.

However, commands required for certain mode of operation can be entered.

Such commands include:

- flow meter serial test start and stop command
- batch control start and stop command

9.1.1 Stream data

9.1.1.1 Summary display 1, 2, 3 and 4

Route in the menu tree:

Main menu	Submenu 1	Submenu 2	Submenu 3
Flow	Streams	Summary display	data page (1.1.1)
		Summary display 2	data page (1.1.8)
		Summary display 3	data page (1.1.9)
		Summary display 4	data page (1.1.10)

The summary displays collect together the most important metered and calculated data for each metering stream. The data items to be shown on the summary displays are editable. They can be edited in the menu:

Main menu	Submenu 1	Submenu 2	Submenu 3	Submenu 4	Submenu 5
Parameters	General data	User defined	Display	Summary display	data page (2.3.3.1.1)

The operator can modify the default display or build a very new one most suitable for the particular application.

There are four summary displays available in the flow computer.

Summary display 1 has the default content as shown in the figure below.

Summary display 2 shows the same data as summary display 1 but with double sized characters for better visibility. This is the default display page appearing on the display if no any key is pressed on the keypad for more then 2 minute.

Summary display 3 shows the previous month data by default.

Summary display 4 shows the current month data by default.

The operator can create his own set of displayed data here if desired.

01.Str. M1	
CVOL flowrate	4 065.8723 m ³ /h
ENGY flowrate	149.5568 GJ/h
Gauge pressure	10.1587 bar
Abs. pressure	11.1587 bar
Temperature	18.6464 °C
Temp. at '+' side	18.6464 °C
Inuse diff.press.	18.6055 mbar
Relative density	0.6357
Base density	0.7790 kg/m ³
Line density	8.6831 kg/m ³
Inf.cal.value	36.7834 MJ/m ³
Sup.cal.value	40.7191 MJ/m ³
2010.09.30. 15:42:07	
← → ↕ Menu	

Figure 9-17 The default summary display

The first line of the display identifies the metering stream as follows.

nn.Str. Stream name

where *nn* the stream number from 01 to 12

Stream name any string entered for the stream as name in the stream parameters.

Function of the F keys on the summary display data page:

- ⇐ go to the summary display of the previous metering stream
- ⇒ go to the summary display of the next metering stream
- ⇅ for Summary display 1 scrolls through data pages
 - Summary display 1
 - Summary display 3
 - Summary display 4
 - Flow rates
 - Cumulative totals
 - Cumulative premium totals
 - Cumulative fault totals
- ⇅ for Summary display 2 scrolls through data lines
- Menu** returns to the parent menu.

9.1.1.2 Periodic totals

Route in the menu tree:

Main menu	Submenu 1	Submenu 2	Submenu 3
Flow	Streams	Periodic totals	data page (1.1.2)

The periodic totals data page shows the totals for the current and the previous period of the hour, shift, day, multi day and month as shown on the figure below.

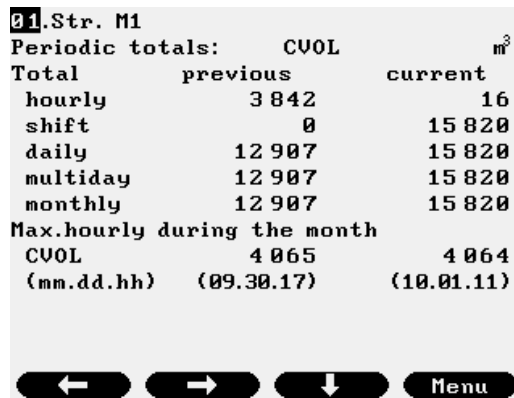

Figure 9-18 Periodic totals

The first line of the display identifies the metering stream.

Function of the F keys on the periodic totals data page:

- ⇐ go to the periodic totals of the previous metering stream
- ⇒ go to the periodic totals of the next metering stream
- ⇅ scrolls through the totals
 - CVOL (volume at base conditions)
 - MASS (mass)
 - ENERGY (energy)
 - UVOL (volume at line conditions)
 - CO2 mass (mass of CO2 emission)
 - Prem. CVOL (premium volume at base conditions)
 - Fault CVOL (fault volume at base conditions)

Menu returns to the parent menu.

9.1.1.3 Flow rates

Route in the menu tree:

Main menu	Submenu 1	Submenu 2	Submenu 3
Flow	Streams	Flow rates	data page (1.1.3)

The flow rates data page shows the instantaneous flow rates as shown on the figure below. The flow rates are displayed in per hour and per day basis as well.

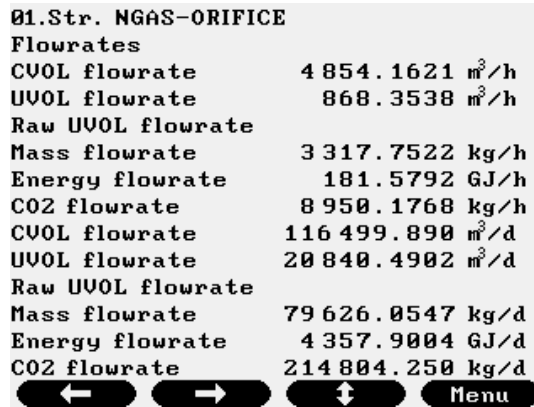

Figure 9-19 Flow rates

The first line of the display identifies the metering stream.

Function of the F keys on the flow rates data page:

- ← go to the flow rates of the previous metering stream
- go to the flow rates of the next metering stream
- ⇅ scrolls through data pages
 - Flow rates
 - Cumulative totals
 - Cumulative premium totals
 - Cumulative fault totals
 - Summary display 1
 - Summary display 3
 - Summary display 4

Menu returns to the parent menu.

9.1.1.4 Cumulative totals

Route in the menu tree:

Main menu	Submenu 1	Submenu 2	Submenu 3
Flow	Streams	Cumulative totals	data page (1.1.4)

The cumulative totals data page shows the non-resettable counters for the totals as shown on the figure below.

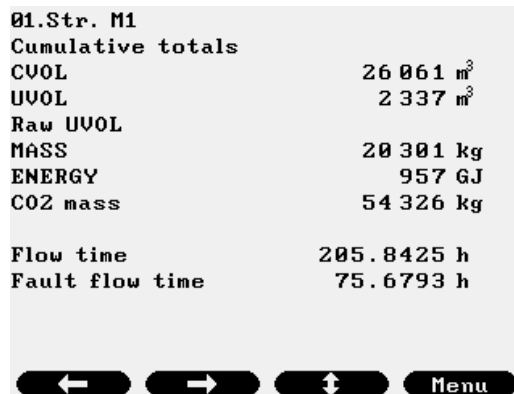

Figure 9-20 Cumulative totals

The first line of the display identifies the metering stream.

Function of the F keys on the cumulative totals data page:

- ← go to the flow rates of the previous metering stream
- go to the flow rates of the next metering stream

- ⇅ scrolls through data pages
 - Cumulative totals
 - Cumulative premium totals
 - Cumulative fault totals
 - Summary display 1
 - Summary display 3
 - Summary display 4
 - Flow rates

Menu returns to the parent menu.

9.1.1.5 Premium totals

Route in the menu tree:

Main menu	Submenu 1	Submenu 2	Submenu 3
Flow	Streams	Premium totals	data page (1.1.5)

The premium totals data page shows the counters for the premium totals measured above the set premium limit as shown on the figure below. Setting of the premium limit see in the menu:

Main menu	Submenu 1	Submenu 2	Submenu 3	Submenu 4
Parameters	Streams	Physical stream	Stream nn	Premium limits

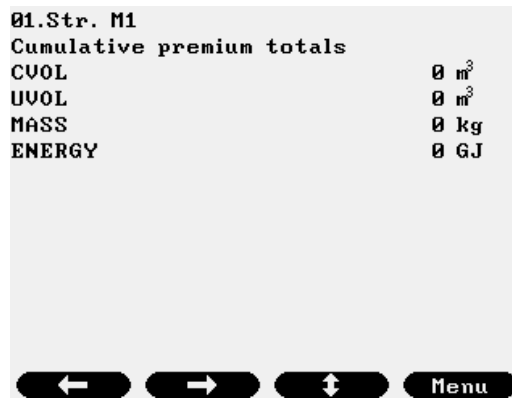

Figure 9-21 Premium totals

The first line of the display identifies the metering stream.

Function of the F keys on the premium totals data page:

- ⇐ go to the flow rates of the previous metering stream
- ⇒ go to the flow rates of the next metering stream
- ⇅ scrolls through data pages
 - Cumulative premium totals
 - Cumulative fault totals
 - Summary display 1
 - Summary display 3
 - Summary display 4
 - Flow rates
 - Cumulative totals

Menu returns to the parent menu.

9.1.1.6 Fault totals

Route in the menu tree:

Main menu	Submenu 1	Submenu 2	Submenu 3
Flow	Streams	Fault totals	data page (1.1.6)

The fault totals data page shows the counters for the fault totals measured under fault conditions as shown on the figure below. Description of the fault conditions see in the section 9.3.

02.Str. M2	
Cumulative fault totals	
CUOL	283 m ³
UVOL	25 m ³
Raw UVOL	25 m ³
MASS	223 kg
ENERGY	10 GJ

← → ↕ Menu

Figure 9-22 Fault totals

The first line of the display identifies the metering stream.

Function of the F keys on the fault totals data page:

- ⇐ go to the flow rates of the previous metering stream
- ⇒ go to the flow rates of the next metering stream
- ⇅ scrolls through data pages
 - Cumulative fault totals
 - Summary display 1
 - Summary display 3
 - Summary display 4
 - Flow rates
 - Cumulative totals
 - Cumulative premium totals

Menu returns to the parent menu.

9.1.1.7 Process data

Inside the process data menu two or more data pages may appear. The content of these data pages depends on the flow meter selected and the fluid to be measured.

The process data menu page is shown on the figure below.

03.Str. ASZK3	
Stream process data	
Flow meter data	
Flow meter diagnostics	
Fluid data	
Inuse gas composition	
Externally received gas composition	
Keypad gas composition	

Change → ↕ Menu

Figure 9-23 Process data menu page

Function of the F keys on the process data menu page:

Change change the metering stream the data to be displayed from

⇒ go to the highlighted data page

⇅ select the next data page

Menu returns to the parent menu.

9.1.1.7.1 Flow meter data

Route in the menu tree:

Main menu	Submenu 1	Submenu 2	Submenu 3	Submenu 4
Flow	Streams	Process data	Flow meter data	data page (1.1.7.1)

This data pages shows the parameters of the flow meter under line conditions and the measured and calculated data directly related to the flow meter. The content of the flow meter data pages for different flow meters shown on the figures below.

01.Str. NGAS-ORIFICE Orifice plate data Flow standard IS05167:2003 dP tappings Flange Disch.coeff.(C) 0.603467 Exp.factor (eps) 0.993963 Vel.of appr.(E) 1.032783 Reynolds number 676 414 Beta 0.499955 Corr.pipe diam. 199.9821 mm Corr.bore diam. 99.9821 mm Pressure loss 67.6369 mbar Temp. at'+ side 11.0271 C Flow velocity 12.1610 m/s		01.Str. NGAS-ORIFICE Orifice plate data Beta 0.499955 Corr.pipe diam. 199.9821 mm Corr.bore diam. 99.9821 mm Pressure loss 67.6381 mbar Temp. at'+ side 11.0271 C Flow velocity 12.1606 m/s Coeff. Kp. 0.000000 Coeff. Ksh 0.000000 Coeff. Kshf 0.000000 Coeff. KRe 0.000000 Coeff. Kt 0.000000 Coeff. Ksu 0.000000	
↑ ↓ Menu		↑ ↓ Menu	

Figure 9-24 Flow meter data for differential pressure devices (orifice, nozzle, Venturi tube)

03.Str. NGAS-TURBINE Meter data		
	Main signal	Check signal
Pulse number	187 786	187 808
Pulse increment	482	481
Frequency	963.008	963.007
K-factor	3 585.9 pls/m ³	
Bad pulses		-1
Total bad pulses		22
Flow velocity	8.5482 m/s	
Menu		

Figure 9-25 Flow meter data for pulse output flow meters (turbine meter, Vortex meter, etc.)

03.Str. ASZK3 FLOWSIC meter data UVOL flowrate 4 000.0000 m ³ /h	
Avg gas velocity	10.0000 m/s
path 1	10.0000 m/s
path 2	10.0000 m/s
path 3	10.0000 m/s
path 4	10.0000 m/s
Avg UOS	400.0000 m/s
path 1	400.0000 m/s
path 2	400.0000 m/s
path 3	400.0000 m/s
path 4	400.0000 m/s
Forward UVOL	3 322.9 m ³
↑ ↓ Menu	

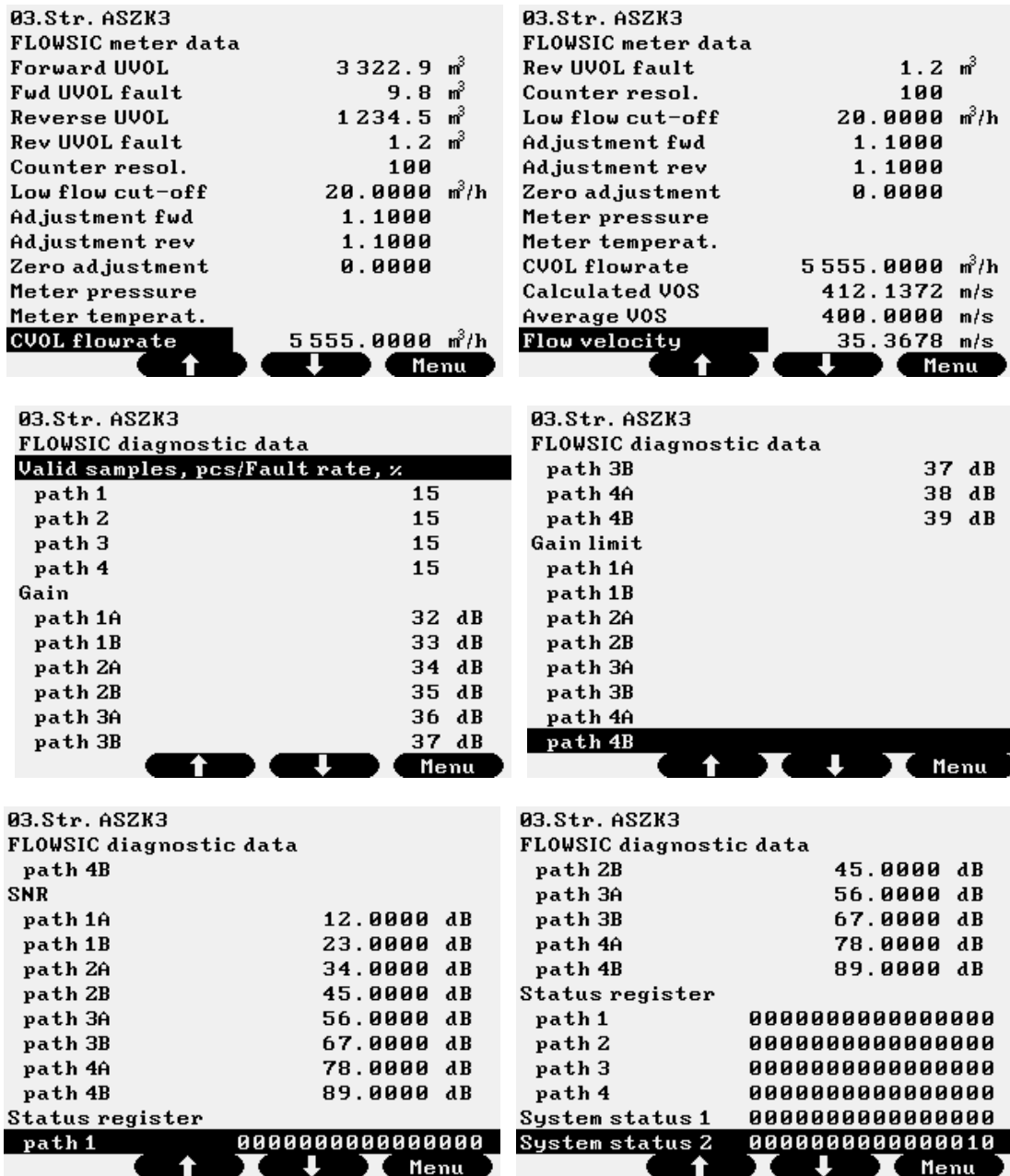

Figure 9-26 Flow meter data (Flowvic-600 US meter, serial communication)

The content of the flow meter data pages for ultrasonic flow meters depends on the type of ultrasonic meter.

Function of the F keys on the flow meter data page:

- ← returns to the Process data menu page
- ⇅ scrolls through data lines on the data page if not all the line fit on one display
- Menu** returns to the parent menu.

9.1.1.7.2 Fluid data

Route in the menu tree:

Main menu	Submenu 1	Submenu 2	Submenu 3	Submenu 4
Flow	Streams	Process data	Fluid data	data page (1.1.7.2)

The fluid data page shows the fluid properties. The content of the data page highly depends on the fluid selected. Examples of the data pages are shown on the figures below.

01.Str. ASZK1		01.Str. ASZK1	
Fluid data		Fluid data	
Fluid	natural gas	Fluid	natural gas
Dynamic viscos.	1.0685e-05 Pasec	Conversion factor	2.0131
Isentropic expon.	1.309989	Relative density	0.554797
Base compr.fact.	0.998024	Base density	0.679854 kg/m ³
Line compr.fact.	0.995852	Line density	1.368603 kg/m ³
Line/Base compr.	0.997823	Inf.cal.value	34.0156 MJ/m ³
Conversion factor	2.0131	Sup.cal.value	37.7816 MJ/m ³
Relative density	0.554797	J-T coefficient	0.4859 °C/bar
Base density	0.679854 kg/m ³	Spec.carbon cont.	0.5090 kg/m ³
Line density	1.368603 kg/m ³	Calculated VOS	437.5371 m/s
Inf.cal.value	34.0156 MJ/m ³	Methane number	108.4
Sup.cal.value	37.7816 MJ/m ³	Wobbe index(gross)	50.7240 MJ/m ³

Figure 9-27 Fluid data for natural gas

04.Str. CR.OIL-LIQ.TURBINE		04.Str. CR.OIL-LIQ.TURBINE	
Fluid data		Fluid data	
Fluid	crude oil	Fluid	crude oil
Uncor.dens.A	780.000000 kg/m ³	CtLd	1.003790
Uncor.dens.B	853.909973 kg/m ³	CpLd	1.000927
D.met.Ahous.T	0.000000 C	CtpLd	1.004720
D.met.Bhous.T	0.000000 C	Alpha	0.0012647 1/°C
Inuse meas.dens	700.000000 kg/m ³	Fluid temp@meter	11.000000 C
Base density	696.711275 kg/m ³	Fluid pres@meter	4.348644 bar
Line density	700.538111 kg/m ³	Fp(m)	1.3114e-04 1/bar
Fluid temp.@dens	12.000000 C	CtLm	1.005051
Fluid pres.@dens	8.000000 bar	CpLm	1.000439
Fp(d)	1.3231e-04 1/bar	CtpLm	1.005493
CtLd	1.003790	Inf.cal.value	40.360001 MJ/kg

04.Str. CR.OIL-LIQ.TURBINE	
Fluid data	
Fluid	crude oil
Alpha	0.0012647 1/°C
Fluid temp@meter	11.000000 C
Fluid pres@meter	4.348636 bar
Fp(m)	1.3114e-04 1/bar
CtLm	1.005051
CpLm	1.000439
CtpLm	1.005493
Inf.cal.value	40.360001 MJ/kg
Kinematic viscosity	30 mm ² /s
Dynamic viscosity	0.0210161 Pasec
Specific carbon	0.807420 kg/kg

Figure 9-28 Fluid data for crude oil and refined products

01.Str. ProdPlant1 - ethanol1		01.Str. ProdPlant1 - ethanol1	
Fluid data		Fluid data	
Fluid	ethanol	Fluid	ethanol
Meas.density	805.000000 kg/m ³	Mix.base dens.	804.839001 kg/m ³
Mix.line dens.	805.000001 kg/m ³	Eth.base dens.	789.234963 kg/m ³
Mix.base dens.	804.839001 kg/m ³	Ethanol x(m/m)	94.753628 %
Eth.base dens.	789.234963 kg/m ³	Ethanol x(v/v)	96.627011 %
Ethanol x(m/m)	94.753628 %	Dynamic viscos.	0.001 Pasec
Ethanol x(v/v)	96.627011 %	Fluid temp.@dens	20.000000 °C
Dynamic viscos.	0.001 Pasec	Fluid pres.@dens	3.500000 bar
Fluid temp.@dens	20.000000 °C	Fluid temp@meter	20.000000 °C
Fluid pres.@dens	3.500000 bar	Fluid pres@meter	3.500001 bar
Fluid temp@meter	20.000000 °C	CpLd	1.000200
Fluid pres@meter	3.500001 bar	CpLm	1.000200

Figure 9-29 Fluid data for ethanol

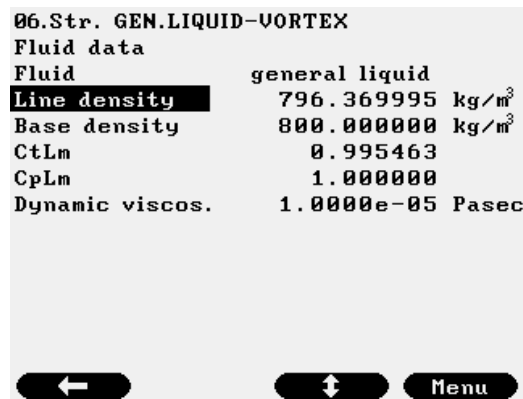

Figure 9-30 Fluid data for general liquid

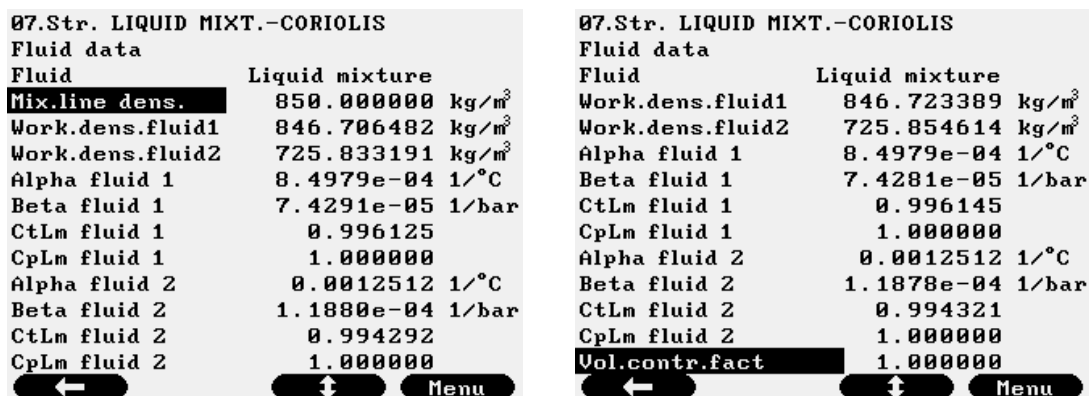

Figure 9-31 Fluid data for liquid mixture

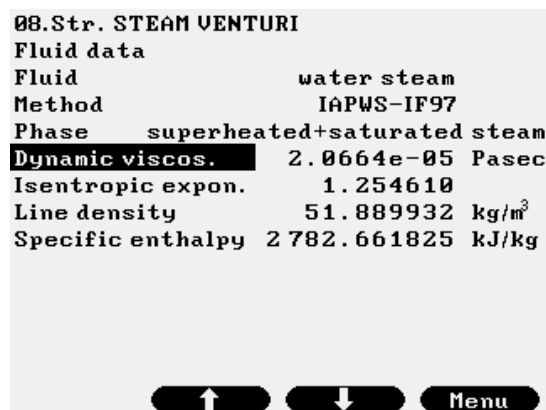

Figure 9-32 Fluid data for water steam

Function of the F keys on the fluid data data page:

← returns to the Process data menu page

⇅ scrolls through data lines on the data page if not all the lines fit on one display

Menu returns to the parent menu.

9.1.1.7.3 Gas composition related data pages

Route in the menu tree:

Main menu	Submenu 1	Submenu 2	Submenu 3	Submenu 4
Flow	Streams	Process data	Gas composition	data page (1.1.7.3)

In case of natural gas flow measurement, the gas composition used in calculations, received externally (read from gas chromatograph or downloaded from the supervisory system) and the keypad gas composition are shown on separate data page as shown below.

01.Str. NGAS-ORIFICE			
N2	0.7632	npentane	0.0098
CO2	0.0489	nhexane	0.0196
H2S	0.0000	nheptane	0.0000
H2O	0.1996	noctane	0.0000
helium	0.0000	nnonane	0.0000
methane	95.8377	ndecane	0.0000
ethane	0.7925	oxygen	0.0000
propane	0.2642	CO	0.0000
ibutane	0.0489	H2	1.9569
nbutane	0.0489	argon	0.0000
ipentane	0.0098		
Other component		Total:	100.0000

Figure 9-33 In-use gas composition data for natural gas

01.Str. ASZK1			
Gas composition source: chromatograph			
N2	5.1000	npentane	0.0810
CO2	1.0100	nhexane	0.0147
H2S	0.0000	nheptane	0.0110
H2O	0.0000	noctane	0.0053
helium	0.0000	nnonane	0.0000
methane	90.4570	ndecane	0.0000
ethane	1.6000	oxygen	0.0000
propane	0.7000	CO	0.0000
ibutane	0.5000	H2	0.0000
nbutane	0.5000	argon	0.0000
ipentane	0.0210		
Other components		Total:	100.0000

Figure 9-34 Externally received gas composition data for natural gas

02.Str. ASZK2			
N2	0.3940	npentane	0.1996
CO2	1.9730	nhexane	0.0447
H2S	0.0000	nheptane	0.0133
H2O	0.0000	noctane	0.0004
helium	0.0000	nnonane	0.0000
methane	83.7500	ndecane	0.0000
ethane	9.3490	oxygen	0.0000
propane	3.3080	CO	0.0000
ibutane	0.0000	H2	0.0000
nbutane	0.9680	argon	0.0000
ipentane	0.0000		
Other components		Total:	100.0000

Figure 9-35 Keypad gas composition data for natural gas

Function of the F keys on the gas composition data page:

← returns to the Process data menu page

⇅ scrolls through data lines on the data page if not all the lines fit on one display

Menu returns to the parent menu.

9.1.2 Plant I/O

Route in the menu tree:

Main menu	Submenu 1	Submenu 2	Submenu 3
Flow	Plant I/O	I/O board 1	data page (1.2.1)
		I/O board 2	data page (1.2.2)
		I/O board 3	data page (1.2.3)

I/O board 4	data page (1.2.4)
I/O board 5	data page (1.2.5)
Modbus signals	data page (1.2.6)

The data pages in the plant I/O submenu show:

- signals in engineering unit for current, PRT/RTD and frequency input and current output channels;
- states for digital input and digital output channels.

Data pages for the different type of the I/O boards shown on the figures below.

5.IO Board ANI8	
1 DP1	6.339 mbar
2 DP2	27.137 mbar
3 DP3	142.217 mbar
4 P	5.522 bar
5 T	10.294 °C
6 VORTEX	430.086 m ³ /h
7 CORIOLIS	552.826 kg/h
8 DENSITY	939.646 kg/m ³

Figure 9-36 I/O board *n* data page for ANI8 board

- Channel 1, 2 and 3 configured to measure differential pressure
- Channel 4 configured to measure pressure
- Channel 5 configured to measure temperature on current input
- Channel 6 configured to measure volume flow rate on current input
- Channel 7 configured to measure mass flow rate on current input
- Channel 8 configured to measure density on current input

1.IO Board ANI4PT2	
1 DP1.M1	45.960 mbar
2 DP2.M1	214.575 mbar
3 P.M1	5.530 bar
4 QM.M5	3643.067 kg/h
5 T.M1	19.466 °C
6	inactive

Figure 9-37 I/O board *n* data page for ANI4PT2 board

- Channel 1 and 2 configured to measure differential pressure
- Channel 3 configured to measure pressure.
- Channel 4 configured to measure mass flow rate signal.
- Channel 5 configured to measure temperature from PRT sensor.
- Channel 6 is not used, it is inactive.

Figure 9-40 Modbus signal data page

Channel 1 configured for Sick ultrasonic meter

Function of the F keys on the I/O board data page:

- ⇒ display the I/O signals on the board in the next slot
- ⇐ display the I/O signals on the board in the previous slot
- ⇕ scrolls through channels of the I/O board

Menu returns to the parent menu.

9.1.3 Archive data

Route in the menu tree:

Main menu	Submenu 1	Submenu 2	Submenu 3
Flow	Archived data	Periodic totals	data page (1.3.1)
		Batch data	data page (1.3.2)

UNIFLOW-200 has an extensive data archive.

The archived data divided into two subgroups:

- archived periodic totals;
- archived batch data;

The most convenient way to access the archived data is to read them via the Ethernet link by means of UNIArchive software. However all the archive data can be called on the display as well, if PC is not available.

9.1.3.1 Archived periodic totals

The archive data data page is shown on the figure below.

01.Str. NGAS-ORIFICE			
Archive hourly values 2010.10.19			
CVOL	m ³	PressG	Temp. °C
	total	average	average
7	*	*	*
8	4 245	4.537870	19.44961
9	4 753	4.537494	19.43871
10	4 754	4.538520	19.45577
11	4 760	4.544064	19.50669
12	4 756	4.540540	19.44350
13	4 755	4.539455	19.43900
14	4 754	4.539127	19.43771

Select ↓ Chart Menu

Figure 9-41 Archive data data page

Configured to display

- hourly totals for volume at base conditions;
- hourly average of the gauge pressure;
- hourly average of the temperature

The totals are displayed for 19 October 2010 for the hours from 7 to 14.

Data are displayed in three columns preceding with serial number of the periods in the first column.

The selection of the data to be displayed and the time period is done by the function keys as described below.

Press ⇐ key to select the field to be edited. Press ⇑ key to scroll through the items from selection list in the data field or press Change key to enter the numeric fields. The editable fields and their values are as follows.

- stream number from 01 to 12
- period field: hourly, shift, daily, multi day, monthly
- date field: yyyy mm dd
- variable name field:
 - CVOL m³ (volume at base conditions);
 - UVOL m³ (volume at line conditions);
 - MASS kg (mass)
 - ENGY GJ (energy)
 - CO2MASS kg (mass of CO2 emission)
 - RAW UVOL m³ (volume at line conditions before applying any error curve correction);
 - Temp. °C (temperature)
 - dP mbar (differential pressure)
 - fltCVOL m³ (fault volume at base conditions);

- o fltUVOL m³(fault volume at line conditions);
- o fltMASS kg (fault mass);
- o fltENGY GJ (fault energy);
- o PressG bar (gauge pressure);
- o Dens. kg/m³ (line density);
- o Rel.Dens. - (relative density);
- o premCVOL m³ (premium volume at base conditions);
- o premUVOL m³ (premium volume at line conditions);
- o premMASS kg (premium mass);
- o premENGY GJ (premium energy);
- o PressA bar (absolute pressure);
- o K(Zl/Zb) (ratio of the compression factor at line conditions to base conditions);
- o inf.cal MJ/m³ (inferior calorific value);
- o sup.cal MJ/m³ (superior calorific value)
- o No of cycl. (number of calculation cycles);
- variable type subfield:
 - For totals this subfield can be selected as:
 - o total (displays the period counter for the selected period);
 - o min. (displays the minimum flow rate for the flow corresponding to the total, e.g. minimum mass flow rate for the mass total);
 - o max. (displays the maximum flow rate for the flow corresponding to the total, e.g. maximum mass flow rate for the mass total);
 - For non total variables this subfield can be selected as:
 - o average (displays the average value of the variable for the selected period);
 - o min. (displays the minimum value for the selected variable in the selected period);
 - o max. (displays the maximum value for the selected variable in the selected period);

Press OK key after all the selection is done.

The data are displayed on the screen and the first data line is highlighted.

Press ↓ and ↑ keys for scrolling through the data lines.

Press ⇄ key for selecting the editable fields to select different data for different periods to be displayed.

Press Menu key to return to the parent menu.

Function of the F keys on the Archive data page:

- ⇄ select the next field for editing
- ⇅ select the data item in the field being edited
- OK** confirm the selection and display the data
- ↓ select the next data line
- ↑ select the previous data line
- Menu** returns to the parent menu.

9.1.3.2 Archived batch data

The archived batch data data page is shown on the figure below.

Archived batch data				2011.01.10
1Str Load_1				
SZEGERD				
KRB-349				
Batch started		2011.01.10 13:02:29		
Batch stopped		2011.01.10 15:32:13		
Nr.	Mass	kg	Dens. kg/m ³	Temp. °C
	total		average	average
1	2495		846.6184	21.1554

Select ↓ Print Menu

Figure 9-42 Archive batch data page

The navigation on the archived batch data page and the selection of the measured value to be displayed are identical to those for the archived periodic totals.

9.1.4 Modbus registers

Route in the menu tree:

Main menu	Submenu 1	Submenu 2
Flow	Modbus registers	data page (1.4)

The data communication with UNIFLOW-200 is implemented with Modbus protocol. The content of the Modbus registers can be displayed in this menu item. It can be useful in trouble-shooting if PC is not available for some reason.

The Modbus register data page is shown on the figure below.

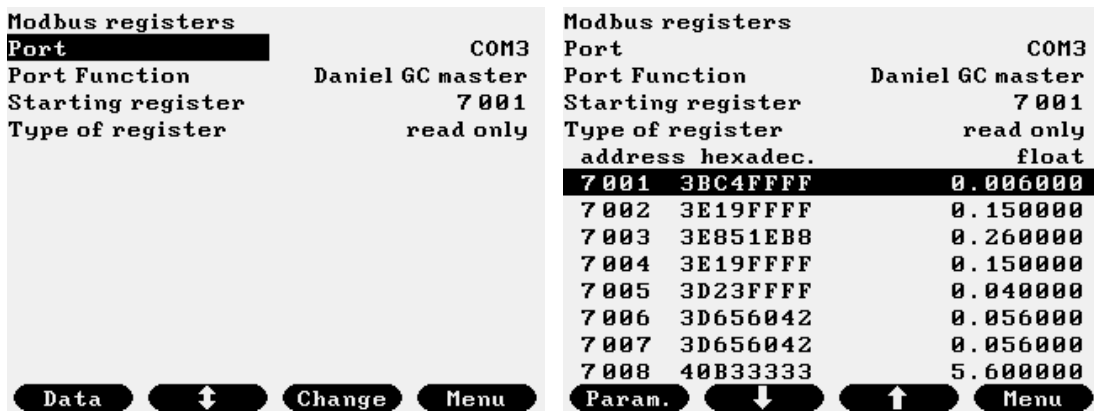

Figure 9-43 Modbus registers data page

First the port has to be selected.

Available options are: Ethernet, Com1, and optionally from Com2 to Com8, depending the number of serial extension module/board installed.

Once the port is selected the Port function is displayed automatically as set-up in the “Interfaces” menu (see 9.2.4.).

The starting register to be displayed can be entered.

Pressing the Data key, the content of the registers displayed in hexadecimal and decimal format. The number format (short integer, integer, float) displayed as well.

See the register maps for different Port functions in Section 11.

Function of the F keys on the Modbus registers data page:

- ↔ select the next field for editing
- ⇅ select the data item in the field being edited
- OK confirm the selection and display the data
- ↓ select the next data line
- ↑ select the previous data line
- Menu returns to the parent menu.

9.1.5 Data transfer

Route in the menu tree:

Main menu	Submenu 1	Submenu 2
Flow	Data transfer	data page (1.5)

The most convenient way to access the archived data of the UNIFLOW-200 is to read them via the Ethernet link by means of UNIArchive software. If this method of accessing the files is not available for some reason then data retrieval (sending data files to the serial or USB port) can be initiated in this menu.

There are several archive files available in the UNIFLOW-200. All of them can be sent to the serial or USB port, however not all of them are optimized for printer.

The reports Month (short daily) and Month (short hourly) are optimized for printer. The delimiter character is space in these files and they can be printed on standard 80-character wide printer.

The rest of the files have semicolon delimiter character and they are wider than 80 columns. They can be caught on the serial or port of PC by some terminal program and saved on the hard disk for further evaluation or can be written to pen drive on the USB port.

The archive data files sent to the serial or USB port make use of UTF8 encoding. To display the archive data file on external device it shall be set accordingly. Otherwise some of the characters on the reports might not be displayed properly.

The data transfer data page is shown on the figure below.

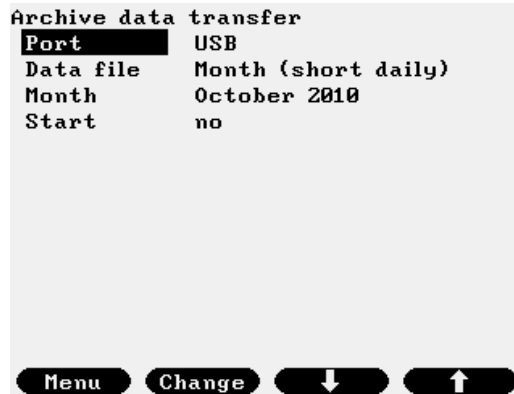

Figure 9-44 Data transfer data page

The editable fields and their content are as follows:

- Port where the files to be sent
 - USB (Flash drive);
 - Com1
 - Com2
 - Com3
- Data file (The available reports for selection are)
 - Monthly short reports
 - Select all
 - Month (daily short)(*);
 - Month (hourly short)(*);
 - Month (daily defined 1);
 - Month (hourly defined 1);
 - Month (daily defined 2);
 - Month (hourly defined 2);
 - Monthly standard reports
 - Select all
 - Month (multiday);
 - Month (daily);
 - Month (shift);
 - Month (hourly);
 - Year (monthly);
 - Daily short reports
 - Prev. Day (hourly short)(*)
 - Cur. Day (hourly short)(*)
 - Prev. Day (hourly defined 1)
 - Cur. Day (hourly defined 1)
 - Prev. Day (hourly defined 2)
 - Cur. Day (hourly defined 2)
 - ...
 - Prev. Day (hourly defined 10)
 - Cur. Day (hourly defined 10)
 - Web defined reports
 - Web defined report 11
 - Web defined report 12
 - Web defined report 13
 - Web defined report 14
 - Web defined report 15
 - Web defined report 16

- Web defined report 17
- Web defined report 18
- Monthly batches;
- Meter serial test;
- Snapshot;
- Logs;
- Parameter project;
- Comm. monitor logs;
- FC calibration report;
- Month. Select the month for which the report to be transferred.
- Start. Select value "Yes" for this field to initiate file sending

There are separate short reports for each metering stream (from 01 to 12). Reports for all streams will be sent out once the Start is selected. Reports denoted with asterisk (*) (short type reports) are available only for metering streams where the fluid is natural gas. The non-short reports include data for all the streams.

Sample of the different short reports are shown in Annex A.

Function of the F keys on the Data transfer data page:

- ⇩ select the next field for editing
- ⇧ select the previous field for editing

Change modify the selected data field

OK Confirm the selection

Menu returns to the parent menu.

9.1.6 Extra summary display

Route in the menu tree:

Main menu	Submenu 1	Submenu 2	Submenu 3
Flow	Extra sum. display	Extra sum. disp1	data page (1.6.1)
		Extra sum. disp2	data page (1.6.2)
		Extra sum. large1	data page (1.6.3)
		Extra sum. large2	data page (1.6.4)

There are two extra summary displays available in the UNIFLOW-200. Both of them can be displayed with double sized characters as well.

The main difference between the summary display and extra summary display is that on the extra summary display data from different metering streams can be grouped together. In case of multi stream application it helps the operator to overview the desired data from different streams on one single display.

01.Str. NGAS-ORIFICE	
CVOL	42 728 465 m ³
02.Str. NGAS-US METER	
CVOL	0 m ³
03.Str. NGAS-TURBINE	
CVOL	115 415 m ³
04.Str. CR.OIL-LIQ.TURBINE	
CVOL	21 197 m ³
05.Str. ETHANOL-CORIOLIS	
CVOL	472 m ³
06.Str. GEN.LIQUID-VORTEX	
CVOL	21 186 m ³
08.Str. STEAM-VENTURI	
MASS	1 029 594 t
Menu	

Figure 9-45 Extra summary display

The extra summary displays are empty by default.

The operator can edit them in the menu:

Main menu	Submenu 1	Submenu 2	Submenu 3	Submenu 4
Parameters	General data	User defined	Display	Summary display

9.1.7 Batches

9.1.7.1 Tank loading batch

Route in the menu tree:

Main menu	Submenu 1	Submenu 2	Submenu 3
Flow	Batches	Tank loading	data page (1.7.1)

The batch measurement was designed for tank loading system shown on the Figure 9-38.

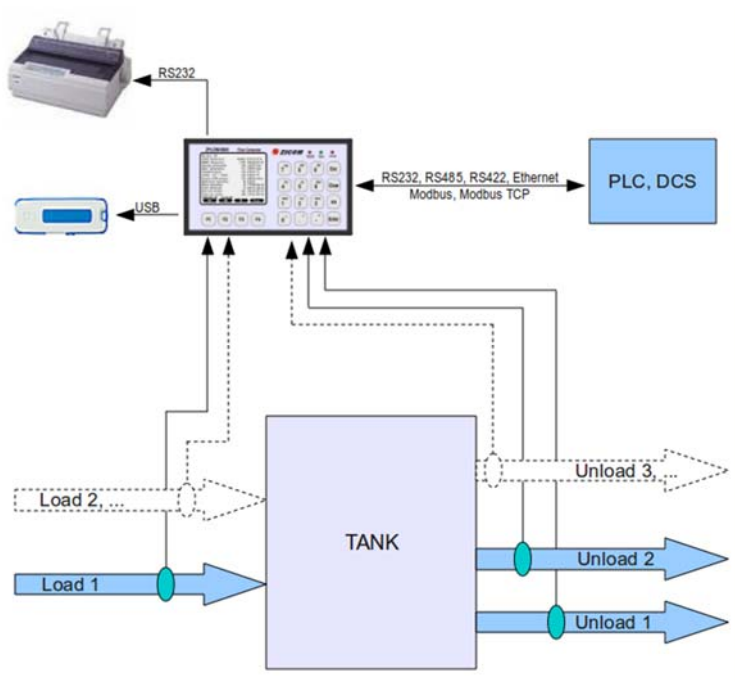

Figure 9-46 Tank loading/unloading system with batch measurement

In the batch measurement the flow measured between the batch start and batch stop signal totalized in separate counters as batch totals. Separate averages are also calculated for the batch.

Batch measurement is enabled/disabled for each metering stream in the Stream setup menu. See in 9.2.2.1.3. Stream setup.

The progress of the batch measurement can be monitored and the results of the last batch can be displayed on the batch display as shown below.

Batches	start/stop
1Str Load_1	in progress
2Str Load_2	stopped
3Str Unload_3	stopped

SZEGED				
KRB-349				
Batch started	11.01.10	13:02:29		
Batch stopped				
Nr. Mass	kg	ron	kg/m ³	PressA bar
0	2 326	851.82940	1.0000009	
Select	↓	Menu		

Batches	start/stop
1Str Load_1	stopped
2Str Load_2	stopped
3Str Unload_3	stopped

SZEGED				
KRB-349				
Batch started	11.01.10	13:02:29		
Batch stopped	11.01.10	15:32:13		
Nr. Mass	kg	ron	kg/m ³	PressA bar
1	2 495	851.82940	1.0000009	
Select	↓	Menu		

Figure 9-47 Batch display for tank loading/unloading

For each stream configured the status of the batch measurement is indicated on the upper part of the display as stopped or started.

The lower part of the display shows the batch data for the stream being highlighted as follows:

- batch start time
- batch stop time
- batch number (1 to 999, restarts at the beginning of the month)
- three selected measured batch value

The displayed measured batch values are selectable by the operator from the list:

- Mass kg (mass batch total);
- UVOL m³ (volume at line conditions batch total);
- CVOL m³ (volume at base conditions batch total);
- Dens. kg/m³ (line density batch average);
- Base.D. kg/m³ (base density batch average);
- Meas.D kg/m³ (measured density batch average);
- Temp. oC (temperature batch average);
- PressA bar (absolute pressure batch average);
- PressG bar (gauge pressure batch average);

To display the archived batch data, see 9.1.3.2.

9.1.7.2 Pipeline interface batch

Route in the menu tree:

Main menu	Submenu 1	Submenu 2	Submenu 3
Flow	Batches	Pipeline interface	data page (1.7.2)

The batch measurement was designed to measure different kind of liquids flowing in the same pipeline each after other.

01 Str. ASZK1		in progress	01 Str. ASZK1		stopped
Batch identif.		00123	Batch identif.		00123
Product 04 FUEL OIL		850 kg/m ³	Product 04 FUEL OIL		850 kg/m ³
Batch started	19.05.29	19:40:19	Batch started	19.05.29	19:40:19
Batch stopped			Batch stopped	19.05.29	19:53:09
Base density		871.38 kg/m ³	Base density		871.38 kg/m ³
Line pressure		15 barg	Line pressure		15 barg
Line temperature		28 °C	Line temperature		28 °C
Line density		863.19 kg/m ³	Line density		863.19 kg/m ³
Dens.met.body T		0 °C	Dens.met.body T		0 °C
Mass flowrate		431.59 t/h	Mass flowrate		431.59 t/h
Mass		82.45 t	Mass		92.1 t
CVOL		94.86 m ³	CVOL		105.94 m ³
UVOL		95.76 m ³	UVOL		106.94 m ³
		View 2 Edit Menu			View 2 Edit Menu

Figure 9-48 Batch display for pipeline interface batch

For each stream configured the status of the batch measurement is indicated in the top line of the display as *in progress* or *stopped*.

The lower part of the display shows the batch data for the stream being highlighted as follows:

- batch identifier
- product information
- batch start time
- batch stop time
- nine selected measured batch variable

The displayed measured batch variables are selectable by the operator from the list:

- Mass kg (mass batch total);
- CVOL (volume at base conditions batch total);
- UVOL (volume at line conditions batch total);
- CVOL flowrate (volume at base conditions flow rate)
- UVOL flowrate (volume at line conditions flow rate)
- Mass flowrate (mass flow rate)
- Line pressure;
- Line temperature;
- Line density;

- Base density;
- Dens.met.body T (density meter body temperature);

To display the archived batch data see 9.1.3.2.

9.1.8 Flow meter serial test and flow computer calibration

Route in the menu tree:

Main menu	Submenu 1	Submenu 2
Flow	Meter serial test	data page (1.8)

9.1.8.1 Flow meter serial test

The flow meter serial test measurement was designed for testing two flow meters connected in series as shown on the figure below.

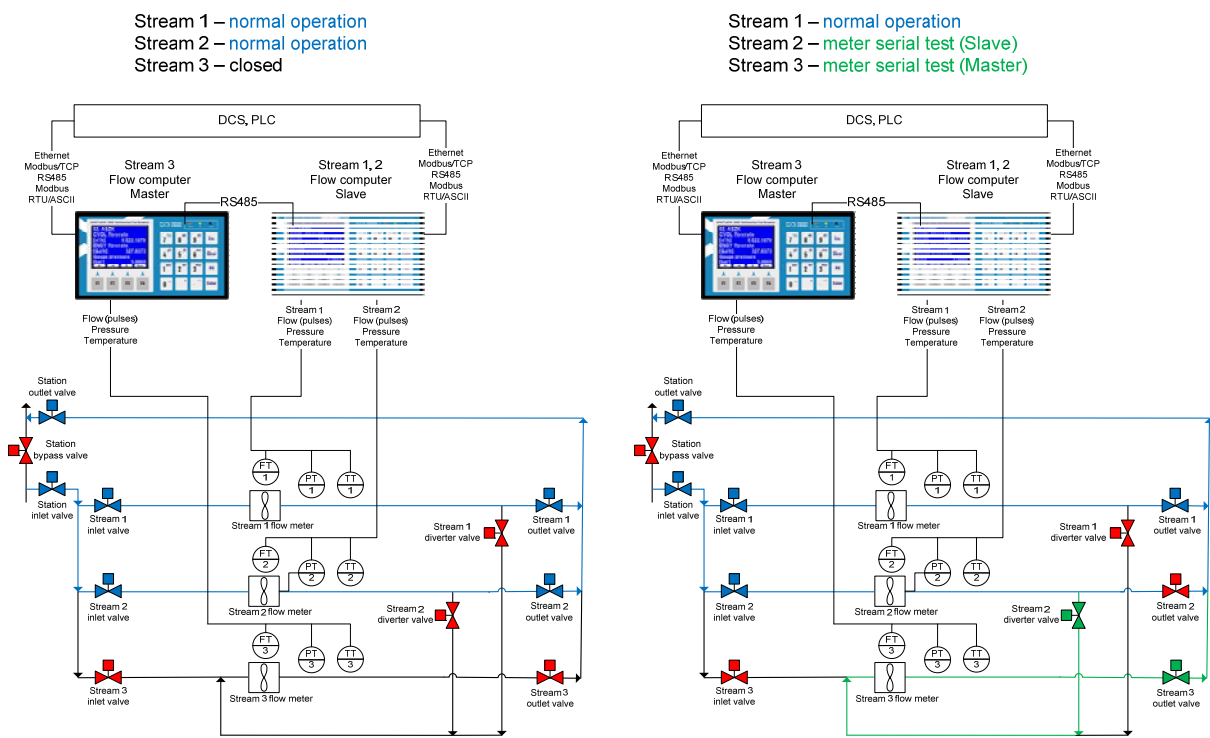

UNIFLOW-200 Application at multistream metering station with flow meter serial test

Figure 9-49 Flow meter serial test measurement

By opening and closing the appropriate valves flow is directed through both meters M1 and M3 or M2 and M3. Quantities measured in the stream being connected in series during the pre-programmed test duration are compared and the deviation is determined.

The meter serial test measurement assumes that:

- separate UNIFLOW-200 flow computers are connected to the Master meter and to the meters under test (Slave meters);
- stream 1 to stream 4 are available for configuration if meter serial test is enabled in both Master and Slave flow computers;
- stream 5 to stream 8 are used as shadow streams;
- during the serial connection of the meters the fluid is measured twice. Not to account these quantities twice one of the flow computers shall be set as “custody transfer stream” and the other as “non custody transfer stream”. In the “non custody transfer stream” flow computer the calculation is performed in stream 5 to 8 (shadow streams);
- two flow computers shall be connected via serial port. In the “non custody transfer stream” flow computer the serial port function shall be set as “Serial test Master”, while in the “custody transfer stream” flow computer the serial port shall be set as “Serial test Slave”.
- the serial test measurement is enabled in the Stream setup menu. See in 9.2.2.1.3.

NOTE

UNIFLOW-200 will not perform any valve control to establish the serial connection of the meters. The appropriate valves shall be controlled manually or by some supervisory system.

UNIFLOW-200 configured as master in communication will read the data from the slave UNIFLOW-200 measured during the serial test and prepares a serial test comparison report.

The progress of the meter serial test measurement can be monitored and the results of the last test can be displayed on the meter serial test display as shown below.

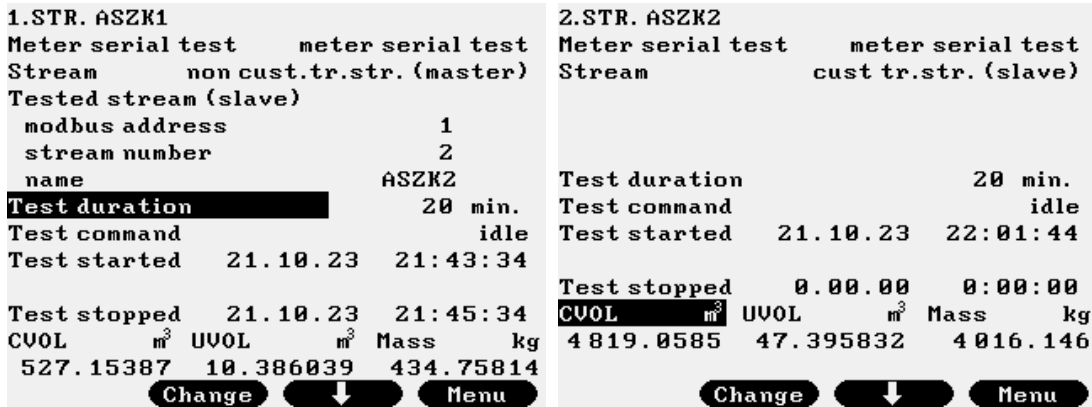

Figure 9-50 Meter serial test display in Master (left) and Slave (right)

Function of the F keys on the Meter serial test data page

↓ select the next field for editing

Change modify the selected data field

OK Confirm the selection

Menu Returns to the parent menu.

The data fields on the data page are as follows:

- Meter serial test;
 - meter serial test; (not editable, set in the stream setup menu)
- Stream;
 - non cust.tr.str. (master); (not editable, set in the stream setup menu)
 - cust.tr.str. (slave); (not editable, set in the stream setup menu)
- Tested stream (slave) (displayed in master device only);
 - modbus address; (selected from the list (available for the serial test Slave flow computers), set in the com port setup menu)
 - stream number; (selected from the available in Slave device streams, from stream 1 to 4)
 - name; (not editable, name of the stream set in the slave device and read by Master device)
- Test duration;

Numeric entry. Enter the duration of the serial test. Valid entry is from 2 to 120 minutes.
- Test command;

Display the status of the test process and this is also the command entry field.

Statuses:

 - idle; (no test in progress)
 - in progress; (test in progress)
 - Master com.param.error; (in Master device only. No com port is configured as Serial test Master)
 - Slave com.param.error; (in Slave device only. No com port is configured as Serial test Slave)
 - Communication error; (no communication with the other device) Moving the cursor with down arrow key until this field is highlighted, commands above the function keys F1 to F4 appear as follows:
 - start; (start the serial test, in Master device only)

- `stop`; (stop the serial test, in Master device only. If stop command is selected the test will be interrupted at the end of next minute and the data will be evaluated);
 - `abort`; (abort the serial test. If abort command is selected the test will be interrupted immediately and the data will not be evaluated).
- Test started;
Start time of the meter serial test.
 - Test stopped;
Stop time of the meter serial test. The last two lines show three of the measured values.
The displayed values are selectable by the operator from the list:
 - UVOL m³ (volume at line conditions);
 - CVOL m³ (volume at base conditions);
 - Mass kg (mass);
 - ENGY GJ (energy);
 - PressG bar (gauge pressure);
 - PressA bar (absolute pressure);
 - Temp. oC (temperature);
 - Zl (compression factor at line conditions);
 - Zn (compression factor at base conditions);
 - Rel.Dens. - (relative density);
 - Base.D kg/m³ (base density);
 - Dens. kg/m³ (line density);
 - ICV MJ/m³ (inferior calorific value);
 - dP mbar (differential pressure);
 - UVOL FR m³/h (volume at line conditions flow rate);
 - CVOL FR m³/h (volume at base conditions flow rate);
 - MASS FR m³/h (mass flow rate);
 - ENGY FR m³/h (energy flow rate);

The control of the serial test can be accomplished via keypad or from the supervisory system (DCS, PLC, etc.) via the User Modbus table (see Annex C for User Modbus editor).

In the Master flow computer control registers can be defined as follows:

- Test duration – write the required test duration in minutes;
- Start command – write 1 into the register to start the test
- Stop command – write 1 into the register to stop the test at the end of current minute
– write 2 into the register to abort the test
- S/N of the Slave device – write the serial number of the Slave device as listed in the Meter serial test Master com port definition screen;
- S/N of the Stream – write the serial number of the stream in the Slave device measuring the stream being connected in series with the Master stream;

Measured data in the Master device, measured data in the Slave device and their deviation can also be assigned to Modbus registers and can be read via port the User Modbus table is assigned to.

In the Slave flow computer, the measured data can be assigned to Modbus registers.

In addition, the Meter Factor (MFactor) of the pulse input channel assigned to the Slave stream being tested can be assigned to Modbus register.

Some supervisory system can run several serial test runs and can determine new Mfactor for the Slave stream.

The new Mfactor can be written into the defined register.

Warning message will appear on the screen of the Slave machine, asking the Operator accept the new MFactor.

If Operator accepts the new MFactor, the appropriate parameter of the pulse input channel assigned to the stream being tested will be updated. Operator can also refuse the new MFactor.

The results of the serial test are stored in Meter serial test report. The last 10 reports are retained in the archive of the flow computer.

The Meter serial test reports can be retrieved with UNIArchive software tool.

They can also be transferred to flash drive via the USB port of the flow computer. See 9.1.5.

Sample report is shown in Annex A.

9.1.8.2 Flow computer calibration

The flow computer calibration function is a subset of the flow meter serial test. The function of Uniflow-200 in the flow computer calibration explained in the figure below.

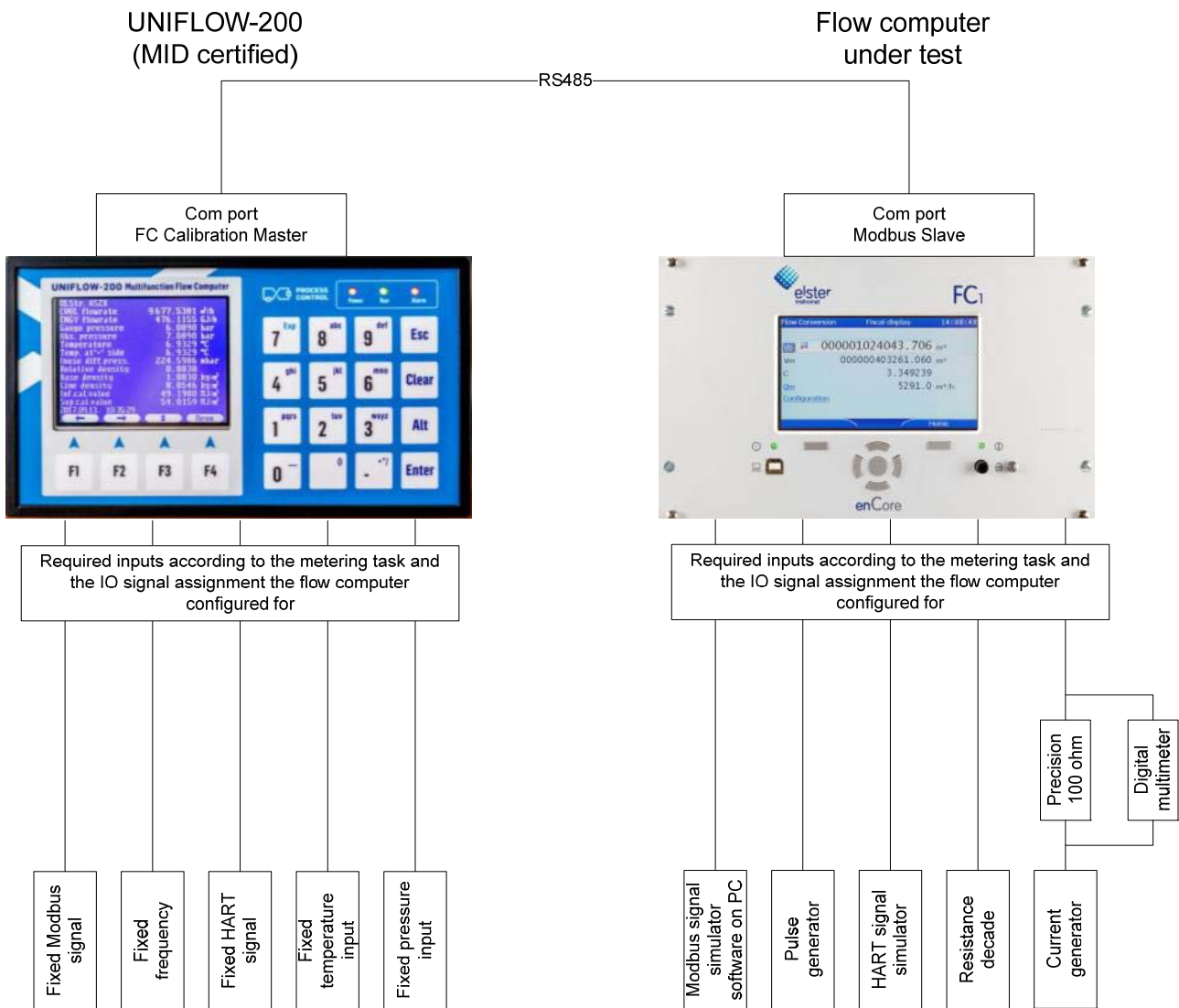

Note:
 On the FC calibration Master port of the Uniflow-200 the
 - data format
 - byte order
 - starting address
 for the cumulative total counter registers:
 - volume at line conditions
 - volume at base conditons
 - mass
 - energy
 shall be set to match the settings in the flow computer under test.

Note:
 On the Modbus Slave port of the FC under test the cumulative total counters shall be configured in four consecutive Modbus registers:
 - volume at line conditions
 - volume at base conditons
 - mass
 - energy

Figure 9-51 Flow computer calibration

Uniflow-200 and the Flow computer under test shall be configured to perform exactly the same metering task (fluid, flow meter, input signals, etc.).

In Uniflow-200 in the stream setup menu the transmitter calibration shall be enabled and the flow pressure and temperature signal shall be set up for the values corresponding to the desired test point.

Input signals for the flow computer under test shall be provided from the appropriate signal generators or simulators.

During the flow computer calibration test Uniflow-200 continuously reads UVOL, CVOL, MASS, ENGY cumulative total counters from the flow computer under test. After the test finished it calculates the total increments of UVOL, CVOL, MASS and ENGY in the flow computer under test as difference between the counter positions at stop and at start signal. Uniflow-200 performs also its own flow calculation and totalization during the test.

At the end of the test Uniflow-200 records its own and the flow computer under test quantities in the FC calibration data reports and also calculates the difference between the quantities.

The flow computers are connected via RS 485 port.

Port function in Uniflow-200 set to FC calibration Master (see 9.2.4.1.) and port function in the flow computer under test shall be set to Modbus Slave.

The flow computer calibration starts and the progress is monitored on the Meter serial test display as can be seen below.

```

1.STR. ASZK1
Meter serial test      flow comp. calibr.
Tested stream (slave)
  modbus address          1
Test duration          20 min.

Test command          in progress
Test started    21.04.25    1:51:58
Time to finish      18 min. 4sec.

UVOL      m³  CUOL      m³  Mass      kg
8 055.5556 12 149.740 8 260.0507
Totals of the calibrated flow computer:
      16 665      31 780      43 454
Abort  Stop  ↓  Menu

```

Figure 9-52 Meter serial test display, flow computer calibration

Function of the F keys on the Meter serial test data page

↓ select the next field for editing

Change modify the selected data field

Abort Interrupt the test being in progress and discard the results, no report generated

Stop Stop the test being in progress at the end of the current minute (not waiting for the test duration expired), results are evaluated and report is generated

OK Confirm the selection

Menu Returns to the parent menu.

The data fields on the data page are as follows:

- Meter serial test;
 - flow computer calibration; (not editable, set in the stream setup menu)
- Stream;
 - non cust.tr.str.(master); (not editable, set in the stream setup menu)
 - cust.tr.str.(slave); (not editable, set in the stream setup menu)
- Tested stream (slave);
 - modbus address; (not editable, set in the com port setup menu)
- Test duration;

Numeric entry. Enter the duration of the serial test. Valid entry is from 2 to 120 minutes.
- Test command;

Display the status of the test process and this is also the command entry field.

Statuses:

 - idle; (no test in progress)
 - in progress; (test in progress)
 - Master com.param.error; (in Master device only. No com port is configured as Serial test Master)
 - Communication error; (no communication with the other device) Highlighting this field command can be selected as follows:
 - start; (start the serial test, in Master device only)
 - stop; (stop the serial test, in Master device only. If stop command is selected the test will be interrupted at the end of next minute and the data will be evaluated);
 - abort; (abort the serial test. If abort command is selected the test will be interrupted immediately and the data will not be evaluated.
- Test started;

Start time of the meter serial test.

- Test stopped;

Stop time of the meter serial test.

The last four lines show three of the measured variables.

The displayed values are selectable by the operator from the list:

- UVOL m³ (volume at line conditions);
- CVOL m³ (volume at base conditions);
- Mass kg (mass);
- ENGY GJ (energy);

In the upper lines the totals calculated in Uniflow-200 are displayed.

In the last line the counters read flow the flow computer under test are displayed.

The results of the serial test are stored in FC calibration data report. The last 10 reports are retained in the archive of the flow computer.

The FC calibration data reports can be retrieved with UNIArchive software tool.

They can also be transferred to flash drive via the USB port of the flow computer. See 9.1.5.

Sample report is shown in Annex A.

9.1.9 PID

See in Section 9.2.7.

9.2 Parameters

This chapter guides through the steps required to setup the UNIFLOW-200 for a particular flow measurement task. It gives the full list of options available for selection in the setup procedure.

UNIFLOW-200 is true multi-function flow computer. Its capabilities allow configuring it for very wide range of applications. As a consequence, the flow computer should be setup for each particular application. The setup is done in the Parameters menu.

Generally, the setup is required only before the start-up of the unit. However, modification of the parameters may become necessary during the normal operation of the flow computer as well. E. g. changing of the orifice bore diameter in case of orifice plate replacement, or, changing the turbine meter K-factor if the turbine meter is replaced are part of the normal daily operational procedure.

The setup can be done via keypad and display. The UNISetup software is also available at the web site of the manufacturer for download making the setup even more convenient and user friendly.

Entering the Parameters menu requires password. Logging in on Operator security level allows modification of limited set of parameters only. At Engineer level all the parameters are alterable. If operator logs in at Guest level then no parameter modification is allowed but all the parameters can be reviewed.

The signal processing and the flow calculation are not interrupted during the parameter editing.

In the editing procedure:

- **OK** key accepts the new value of the parameter
- **Save** key stores the new value in a temporary location

The modified new parameters become active (i. e. the flow computer takes their value in the flow calculation) after the operator left the Parameters menu. Message "Parameter update in progress" is shown on the display when new parameters are activated.

The general rules of navigating the menu and editing data see in the Chapter 6.

It is recommended to setup the parameters in the orders as described in this chapter.

9.2.1 I/O signal setup

Route in the menu tree:

Parameters	I/O signals	I/O board m	Channel n	data page (2.1.m.n)
------------	-------------	-------------	-----------	---------------------

where: *m* serial number of I/O board
n serial number of channel on the board *m*

There are 5 slots in the flow computer capable to accommodate any type of I/O board available.

The setup parameters depend on the type of channel being configured. For example the analog input channel is configured in the same way regardless of its location on the ANI8 or ANI4PT2 board.

The physical parameters of the flow measurement and the input and output channels are not hard wired together in the flow computer. It is part of the setup procedure to assign the physical parameter (for example pressure) to the channel where the pressure transmitter signal is wired to (for example channel 1 on board 1).

The figures below show the settings for each type of channels.

First line of each data page indicates the number of board and channel being edited and the type of the I/O board.

CAUTION

If the channel status is inactive then the channel can not be used in the flow calculation even if you set all the parameters of the channel.

Do not forget to set the channel **active** if you want to use the signal measured at the channel in the flow calculation.

9.2.1.1 Analogue (4-20 mA) input channel

The analogue (4-20 mA) input channel data page is shown on the figure below.

Function of the F keys on the analogue (4-20 mA) input channel data page

- ↓ select the next field for editing
- ↑ select the previous field for editing
- ⇒ remove the highlighted item from the eventing list and step to the next item

Change modify the selected data field

OK Confirm the selection

Save save the selected/entered data and returns to the parent menu.

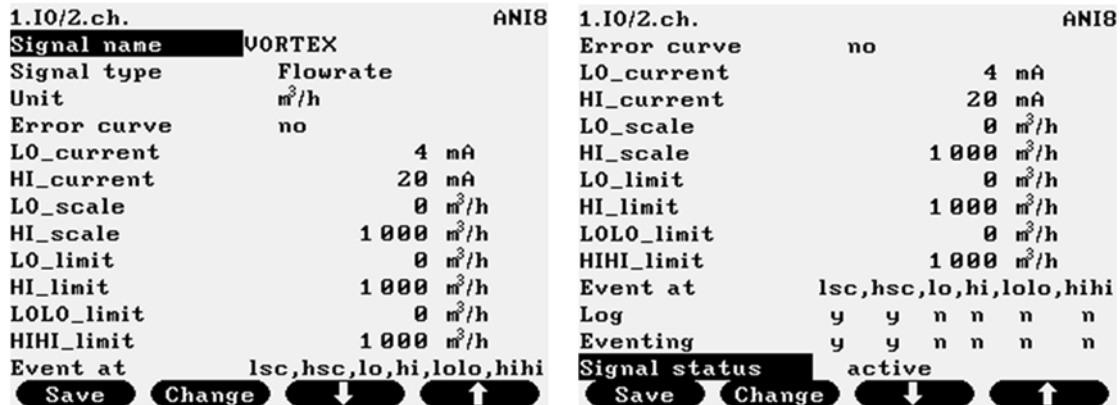

Figure 9-53 Analogue (4-20 mA) input channel data page

The editable fields on the data page are as follows:

- Signal name
Any character string up to 18 characters, for example: FIQ 501 pressure
- Signal type
- Unit

Supplementary parameter (depending on the signal type)

Type of the physical parameter measured at the channel, its unit of measurement and the supplementary parameter are selected from the list below:

- o Differential pressure;
- mbar

- Pa
 - kPa
 - mmH2O
 - inH2O
 - o Flowrate;
 - m³/h
 - kg/h
 - GJ/h
 - MWh/h
 - MVA
 - MCF/h
 - CF/h
 - lb/h
 - MMBTU/h
 - bbl/h
 - Mlb/h
- supplementary parameter: Error curve
- yes
 - supplementary parameter 2: error curve correction type
 - linear interpolation, UVOLFR (m³/h) - Error (%)
 - no

5.10/6.ch.			ANIB	5.10/6.ch.			ANIB
Error curve			linear interpolation				0.639
			UVOLFR(m ³ /h)-Error(%)				
No.	flowrate	K					
1	0	0	0	4	983	0	0.639
2	117	-0.812	0	5	0	0	0
3	479	-0.455	0	6	0	0	0
4	983	0.639	0	7	0	0	0
5	0	0	0	8	0	0	0
6	0	0	0	9	0	0	0
7	0	0	0	10	0	0	0
8	0	0	0	11	0	0	0
9	0	0	0	12	0	0	0
10	0	0	0	13	0	0	0
				14	0	0	0
				15	0	0	0
				16	0	0	0

Figure 9-54 Error curve data page for flow rate signal

Error curve is available for the signals representing:

- volume flow rate at line conditions expressed in m³/h, MCF/h, CF/h, bbl/h
- mass flow rate expressed in kg/h, lb/h, Mlb/h

If the error curve correction is selected for the flow rate signal then new data page opens for entering the error curve points. The volume flow rate at line conditions (in m³/h) or mass flow rate and the error at that flow rate shall be entered from the calibration certificate of the flow meter.

Maximum of 16 error curve point can be entered.

The flow rates shall be entered in increasing order.

- o Pressure;
 - mbar
 - bar
 - kPa
 - MPa
 - mmH2O
 - PSIA or PSIG – depending on the gauge/absolute pressure transmitter selection
- supplementary parameter: type of transmitter
- Gauge pressure
 - Abs. pressure
- o Temperature;
 - °C
 - °F
 - o Density;
 - kg/m³

- lb/CF
- RD
- supplementary parameter: type of transmitter
 - Line density
 - Base density
 - Relative density (unit changes to – (none) for relative density)
- o Special (special signal);
 - %
 - mole%
 - - (none)
 - MJ/m³
 - MJ/kg
 - uS
 - BTU/SCF
 - lb/MMSCF
- o Kin. viscosity (kinematic viscosity);
 - mm²/s
 - cSt
- o Level;
 - m
 - cm
 - mm
 - inch
 supplementary parameters
 - Level equivalent (in level unit/mA)
 - Zero level (in level unit)

Common parameters for input channels regardless of the signal type

- LO_current (low scale of the current input);
- HI_current (high scale of the current input);
- LO_scale (low scale of the parameter in engineering unit);
- HI_scale (high scale of the parameter in engineering unit);
- LO_limit (low alarm limit);
- HI_limit (high alarm limit);
- LOLO_limit (low-low alarm limit);
- HIHI_limit (high-high alarm limit);
- Keypad value; Keypad value is not available for differential pressure, flow rate and level signals. See the activation of the Keypad value in section 9.3. Alarm and events
- Event at;

It can be selected here that which of the events shall initiate an entry in the event log file of the flow computer and which of the events shall generate event in the alarm system. The options are:

 - o lsc (low scale);
 - o hsc (high scale);
 - o lo (lo limit);
 - o hi (hi limit);
 - o lololo (lolo limit);
 - o hihi (hihi limit);
- Log;
- Eventing;

Selecting *y* (*yes*) in the “Log” line causes an entry shall be generated in the log file.

Selecting *n* (*no*) in the Log line causes no entry is generated in the log file. In this case no *y* (*yes*) can be selected in the “Eventing” line

If in the “Log” line *y* (*yes*) is selected, then in the “Eventing” line *y* (*yes*) or *n* (*no*) can be selected, i.e. the operator can decide if the event generates event in the alarm system or not.
- Signal status
 - o active;
 - o inactive;

NOTE

The input channels on the DEI4 I/O board (input for transmitters communicating with Honeywell DE protocol) shall be setup in the same way as analogue (4-20 mA) channels with exception that no LO_current and HI_current parameters are available for these channels.

IMPORTANT

If the signal configured for any channel is to be used in flow calculation then the unit of measurement shall be selected as follows:

In case of metric unit system:

- pressure signal: bar
- differential pressure signal: mbar
- temperature signal: °C

In case of imperial unit system for gas measurement:

- pressure signal: PSIG or PSIA
- differential pressure signal: inH2O
- temperature signal: °F

9.2.1.2 PRT/RTD input channel

The PRT/RTD input channel data page is shown on the figure below.

Function of the F keys on the PRT/RTD input channel data page

- ↓ select the next field for editing
- ↑ select the previous field for editing
- ⇒ remove the highlighted item from the eventing list and step to the next item

Change modify the selected data field

OK confirm the selection

Save save the selected/entered data and returns to the parent menu.

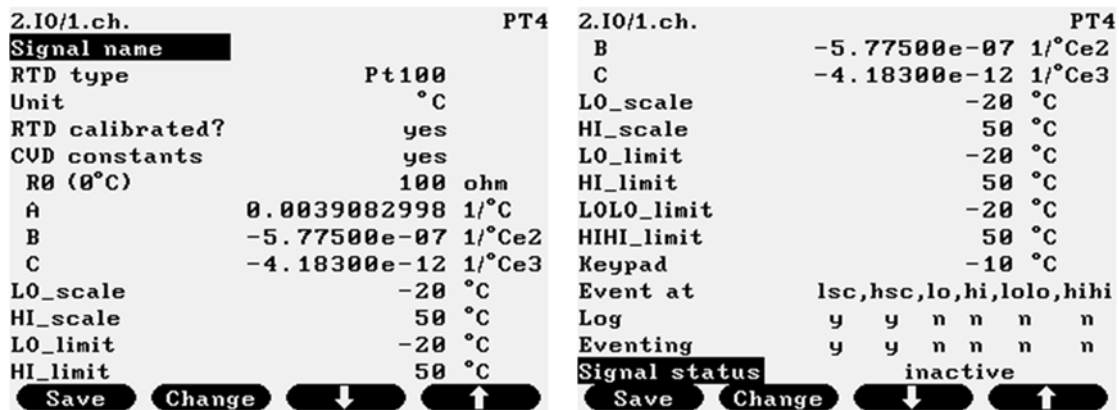

Figure 9-55 PRT/RTD input channel data page

The editable fields on the data page are as follows:

- Signal name
 - Any character string up to 18 characters, for example: FIQ 501 temperature
- RTD type
 - Pt100 (100 ohms at 0 °C) default value - Pt500, Pt1000 and Pt50 on special request;
- Unit
 - °C
 - °F
- RTD calibrated?
 - yes;
 - If yes is selected then it is assumed that the Callendar - Van Dusen (CVD) coefficients are available for the sensor. In this case the CVD constants set to yes automatically and the R0, A, B and C can be edited.
 - no;
 - If no is selected then the default value of the CVD coefficients (from EN 60751) are used to convert the measured resistance to temperature. If CVD constants set to yes then R0, A, B and C are displayed but can not be edited.
- CVD constants (according to EN 60751);
 - yes;

- no;
- R0 (at 0 oC), default value = 100;
- A, default value = 3.9083e-3;
- B, default value = -5.775e-7;
- C, default value = -4.183e-12;
- LO_scale (low scale of the parameter in engineering unit);
- HI_scale (high scale of the parameter in engineering unit);
- LO_limit (low alarm limit);
- HI_limit (high alarm limit);
- LOLO_limit (low-low alarm limit);
- HIHI_limit (high-high alarm limit);
- Keypad value; see the activation of the Keypad value in section 9.3 Alarm and events
- Eventing;

It can be selected here that which of the events shall initiate an entry in the event log file of the flow computer and which of the events shall generate event in the alarm system. The options are:

 - lsc (low scale);
 - hsc (high scale);
 - lo (lo limit);
 - hi (hi limit);
 - lolo (lolo limit);
 - hihi (hihi limit);
- Log
- Eventing

Selecting *y* (*yes*) in the “Log” line causes an entry shall be generated in the log file.

Selecting *n* (*no*) in the Log line causes no entry is generated in the log file. In this case no *y* (*yes*) can be selected in the “Eventing” line.

If in the “Log” line *y* (*yes*) is selected, then in the “Eventing” line *y* (*yes*) or *n* (*no*) can be selected, i.e. the operator can decide if the event generates event in the alarm system or not.
- Signal status
 - active;
 - inactive;

9.2.1.3 Pulse input channel

Depending on the selected signal type of the pulse input the physical parameter represented by the pulse and the data processing are different. The signal types are as follows:

- flow pulse;

Each pulse represents certain amount of fluid passed through the flow meter. The number of pulses is counted and converted into the totals with the K-factor of the flow meter.
- flow check pulse;

This type of pulse input is used to check the pulse train integrity from the flow meter to the flow computer. Flow check pulse input channel is selected in pair with flow pulse channel if the flow meter provides dual pulse output.
- flow frequency;

The frequency of the pulse signal is proportional with the flow rate measured by the meter. The flow computer converts the frequency to the flow rate using the low and high range values and the flow rate then totalized.
- density frequency;

The frequency is proportional to the density measured with the density transducer. The flow computer converts the frequency to the density according to the equation provided by the manufacturer of the densitometer.

The pulse input data page has different view depending on the signal type. The data pages for each signal type are shown below.

Function of the F keys on the pulse input channel data page

↓ select the next field for editing

↑ select the previous field for editing

Change modify the selected data field

OK Confirm the selection

Save save the selected/entered data and returns to the parent menu.

⇒ remove the highlighted item from the eventing list and step to the next item

⇒ enter into error curve definition data page

⇐ left the error curve definition data page

3.I0/1.ch.		PDI0484 / FI1		3.I0/1.ch.		PDI0484 / FI1	
Signal name	TURBINE UVOL			Max. overload	120 %		
Signal type	Flow pulse			K-factor mode	pls/m ³		
Unit	m ³ /h			K-factor	360 pls/m ³		
Pulse transm.	Active 5V			Error curve	no		
Min. UVOL FR	0 %			LO_limit	0 m ³ /h		
Max. UVOL FR	1 000 m ³ /h			HI_limit	1 000 m ³ /h		
Max. overload	120 %			LOLO_limit	0 m ³ /h		
K-factor mode	pls/m ³			HIHI_limit	1 000 m ³ /h		
K-factor	360 pls/m ³			Event at	lo,hi,lolo,hihi		
Error curve	no			Log	y y n n		
LO_limit	0 m ³ /h			Eventing	y y n n		
HI_limit	1 000 m ³ /h			Live/Check signal	Live		
LOLO_limit	0 m ³ /h			Signal status	active		
Save Change ↓ ↑				Save Change ↓ ↑			

Figure 9-56 Pulse input channel (signal type = flow pulse) data page

The editable fields on the data page are as follows:

- Signal name
Any character string up to 18 characters, for example: FIQ 501 main pulse
- Signal type
 - Flow pulse;
- Unit
 - m³/h
 - kg/h
 - GJ/h
 - MWh/h
 - MVA
 - MCF/h
 - lb/h
 - MMBTU/h
 - bbl/h
 - Mlb/h
- Pulse transm. (Pulse transmitter type)
 - active 5 V;
 - active 15 V;
 - OC (open collector) (12 V);
 - NAMUR
- Min. UVOL FR (low metering range of the flow meter, volume flow rate at line conditions, in % of the high metering range)
- Max. UVOL FR (high metering range of the flow meter, volume flow rate at line conditions)
- Max. overload (allowable overload of the flow meter in percent of the high metering range)
- K-factor mode;
 - pulse/unit (volume or mass or energy);
 - unit/pulse;
- K-factor;
- Error curve;
 - yes; (see error curve data page below if yes is selected)
 - no;
- LO_limit (low alarm limit);
- HI_limit (high alarm limit);
- LOLO_limit (low-low alarm limit);
- HIHI_limit (high-high alarm limit);
- Eventing;

It can be selected here that which of the events shall initiate an entry in the event log file of the flow computer and which of the events shall generate event in the alarm system. The options are:

 - lo (lo limit);
 - hi (hi limit);
 - lolo (lolo limit);
 - hihi (hihi limit);
- Log
- Eventing

Selecting **y** (yes) in the "Log" line causes an entry shall be generated in the log file.

Selecting n (no) in the Log line causes no entry is generated in the log file. In this case no y (yes) can be selected in the “Eventing” line.

If in the “Log” line y (yes) is selected, then in the “Eventing” line y (yes) or n (no) can be selected, i.e. the operator can decide if the event generates event in the alarm system or not.

- Live/check signal
 - live;
 - Hz; (enter check signal is Hz)
 - usec; (enter check signal is usec)
- Check signal; (displayed only if Live/check signal set to Hz or usec. This feature is provided for test purpose only. Do not forget to set the Live/check signal to “live” after the test to recover the normal operation of the flow computer.)
- Signal status
 - active;
 - inactive;

2.I0/1.ch.		PDI0484 / FI1		2.I0/1.ch.		PDI0484 / FI1	
Error curve		linear interpolation		4	600	0.2	
		UVOLFR(m ³ /h)-Error(%)		5	1000	-0.45	
No.	flowrate		K				
1	0		0	6	0	0	
2	100		1.1	7	0	0	
3	300		0.6	8	0	0	
4	600		0.2	9	0	0	
5	1000		-0.45	10	0	0	
6	0		0	11	0	0	
7	0		0	12	0	0	
8	0		0	13	0	0	
9	0		0	14	0	0	
10	0		0	15	0	0	
	0		0	16	0	0	

Figure 9-57 Error curve data page (signal type = flow pulse)

If the error curve correction is selected for the flow rate signal then new data page opens for entering the error curve points.

The editable fields on the error curve data page are as follows:

- Error curve type(*)
 - linear interpolation;
 - Maximum of 16 error curve point can be entered in increasing order.
 - polynomial;
 - The coefficients and the power of the polynomial shall be entered up to 6th power.
- In any of the above two cases the independent and the dependent variable of the error curve selected from the list:
- UVOLFR (m³/h) – Error (%);
 - frequency (Hz) – K-factor (pulse/m³);(**)
 - UVOLFR (m³/h) – K-factor (pulse/m³);
 - log(UVOLFR/visc (m³/h/cSt) – K-factor (pulse/m³);
- (*) error curve is available for the units m³/h, kg/h, MCF/h, lb/h, bbl/h, Mlb/h.
 (**) only if linear interpolation is selected

2.I0/2.ch.		PDI0484 / FI2	
Signal name	TURBINE FLOW CHECK		
Signal type	Flow check pulse		
Unit	m ³ /h		
Pulse transm.	Active 5V		
K-factor mode	pls/m ³		
K-factor	3600 pls/m ³		
Live/Check signal	Live		
Signal status	active		

Figure 9-58 Pulse input channel (signal type = flow check pulse) data page

The editable fields on the data page are as follows:

- Signal name
Any character string up to 18 characters, for example: FIQ 501 check pulse
 - Signal type
 - Flow check pulse;
 - Unit
 - m³/h
 - kg/h
 - GJ/h
 - MWh/h
 - MVA
 - MCF/h
 - lb/h
 - MMBTU/h
 - bbl/h
 - Mlb/h
 - Pulse transm. (Pulse transmitter type)
 - active 5 V;
 - active 15 V;
 - open collector (12 V);
 - NAMUR
 - K-factor mode;
 - pulse/unit (volume or mass or energy);
 - unit/pulse;
 - K-factor;
 - Live/check signal
 - live;
 - Hz; (enter check signal is Hz)
 - usec; (enter check signal is usec)
 - Check signal; (displayed only if Live/check signal set to Hz or usec. This feature is provided for test purpose only. Do not forget to set the Live/check signal to "live" after the test to recover the normal operation of the flow computer.)
- Signal status
- active;
 - inactive;

3.I0/3.ch.	PDI0484 / FI3	3.I0/3.ch.	PDI0484 / FI3
Signal name	TURBINE UVOL	L0_frequency	0 Hz
Signal type	Flow frequency	HI_frequency	1 000 Hz
Unit	m ³ /h	L0_scale	0 m ³ /h
Pulse transm.	Active 5V	HI_scale	1 000 m ³ /h
Error curve	no	L0_limit	0 m ³ /h
L0_frequency	0 Hz	HI_limit	1 000 m ³ /h
HI_frequency	1 000 Hz	LOLO_limit	0 m ³ /h
L0_scale	0 m ³ /h	HIHI_limit	1 000 m ³ /h
HI_scale	1 000 m ³ /h	Event at	lsc,hsc,lo,hi,lolo,hihi
L0_limit	0 m ³ /h	Log	y y n n n n
HI_limit	1 000 m ³ /h	Eventing	y y n n n n
LOLO_limit	0 m ³ /h	Live/Check signal	Live
HIHI_limit	1 000 m ³ /h	Signal status	active
Menu	↓ ↑	Menu	↓ ↑

Figure 9-59 Pulse input channel (signal type = flow frequency) data page

The editable fields on the data page are as follows:

- Signal name
Any character string up to 18 characters, for example: FIQ 501 frequency
- Signal type
 - Flow frequency;
- Unit
 - m³/h
 - kg/h

- GJ/h
- MWh/h
- MVA
- MCF/h
- lb/h
- MMBTU/h
- bbl/h
- Mlb/h
- Pulse transm. (Pulse transmitter type)
 - active 5 V;
 - active 15 V;
 - open collector (12 V);
 - NAMUR
- Error curve;
 - yes; (see error curve data page below if yes is selected)
 - no;
- LO_Hz (low scale of the frequency input);
- HI_Hz (high scale of the frequency input);
- LO_scale (low scale of the parameter in engineering unit);
- HI_scale (high scale of the parameter in engineering unit);
- LO_limit (low alarm limit);
- HI_limit (high alarm limit);
- LOLO_limit (low-low alarm limit);
- HIHI_limit (high-high alarm limit);
- Eventing;

It can be selected here that which of the events shall initiate an entry in the event log file of the flow computer and which of the events shall generate event in the alarm system. The options are:

 - lo (lo limit);
 - hi (hi limit);
 - lololo (lolo limit);
 - hihi (hihi limit);
- Log
- Eventing

Selecting *y* (*yes*) in the "Log" line causes an entry shall be generated in the log file.
 Selecting *n* (*no*) in the Log line causes no entry is generated in the log file. In this case no *y* (*yes*) can be selected in the "Eventing" line.
 If in the "Log" line *y* (*yes*) is selected, then in the "Eventing" line *y* (*yes*) or *n* (*no*) can be selected, i.e. the operator can decide if the event generates event in the alarm system or not.
- Live/check signal
 - live;
 - Hz; (enter check signal is Hz)
 - usec; (enter check signal is usec)
- Check signal; (displayed only if Live/check signal set to Hz or usec. This feature is provided for test purpose only. Do not forget to set the Live/check signal to "live" after the test to recover the normal operation of the flow computer.)
- Signal status
 - active;
 - inactive;

2.I0/1.ch. PDIO484 / FI1

Error curve linear interpolation

UVOLFR(m³/h)-Error(%)

No.	flowrate	K
1	0	0
2	100	1.1
3	300	0.6
4	600	0.2
5	1000	-0.45
6	0	0
7	0	0
8	0	0
9	0	0
10	0	0

← Change ↓ ↑

2.I0/1.ch. PDIO484 / FI1

4	600	0.2
5	1000	-0.45
6	0	0
7	0	0
8	0	0
9	0	0
10	0	0
11	0	0
12	0	0
13	0	0
14	0	0
15	0	0
16	0	0

← Change ↓ ↑

Figure 9-60 Error curve data page (signal type = flow frequency)

If the error curve correction is selected for the flow rate signal then new data page opens for entering the error curve points.

The editable fields on the error curve data page are as follows:

- Error curve type (*)
 - linear interpolation;
 - Maximum of 16 error curve point can be entered in increasing order.
 - polynomial;
 - The coefficients and the power of the polynomial shall be entered up to 6th power.
- In any of the above two cases the independent and the dependant variable of the error curve selected from the list:
- UVOLFR (m³/h) – Error (%);
 - frequency (Hz) – K-factor (pulse/m³); (**)
 - UVOLFR (m³/h) – K-factor (pulse/m³);
 - log(UVOLFR/visc (m³/h/cSt) – K-factor (pulse/m³);
- (*) error curve is available for the units m³/h, kg/h, MCF/h, lb/h, bbl/h, Mlb/h.
(**) only if linear interpolation is selected

3.I0/3.ch.		PDI0484 / FI3		3.I0/3.ch.		PDI0484 / FI3	
Signal name	DENSITY1	K21A	-0.0044	K21B	-8.0000e-04		
Signal type	Density	LO_scale			500 kg/m ³		
Unit	kg/m ³	HI_scale			1 100 kg/m ³		
Pulse transm.	Active 5V	LO_limit			500 kg/m ³		
Transm. type	Solatron7835	HI_limit			1 100 kg/m ³		
Density const.		LOLO_limit			500 kg/m ³		
K	1 K0 -1 322	HIHI_limit			1 100 kg/m ³		
K1	-0.125 K2 0.003753	Keypad			780 kg/m ³		
K18	-2.6000e-05 K19 -0.0065	Event at		lsc,hsc,lo,hi,lolo,hihi			
K20A	-3.3000e-06 K20B -6.0000e-07	Log		y y n n n n			
K21A	-0.0044 K21B -8.0000e-04	Eventing		y y n n n n			
LO_scale	500 kg/m ³	Live/Check signal		Live			
HI_scale	1 100 kg/m ³	Signal status		active			
Menu		Menu					

Figure 9-61 Pulse input channel (signal type = density frequency) data page

The editable fields on the data page are as follows:

- Signal name
 - Any character string up to 18 characters, for example: FIQ 501 density
- Signal type
 - Density;
- Unit
 - kg/m³
 - lb/CF
 - RD
- Pulse transm. (Pulse transmitter type)
 - active 5 V;
 - active 15 V;
 - open collector (12 V);
 - NAMUR
- Density transmitter type
 - linear;
 - Solatron 3096R; (unit changes to – (none) for relative density)
 - Solatron 3096N;
 - Solatron 7812;
 - Solatron 7835;
- Density const (constants for the density transducers from the calibration certificate)
 - Solatron 3096R – K0, K2;
 - Solatron 3096N – K0, K2;
 - Solatron 7812 – K0, K1, K2, K3, K4, K18, K19;
 - Solatron 7835 – K, K0, K1, K2, K3, K4, K18, K19, K20A, K20B, K21A, K21B;

(K is a general purpose scale parameter)
- LO_scale (low scale of the parameter in engineering unit);
- HI_scale (high scale of the parameter in engineering unit);

- LO_limit (low alarm limit);
- HI_limit (high alarm limit);
- LOLO_limit (low-low alarm limit);
- HIHI_limit (high-high alarm limit);
- Keypad value; see the activation of the Keypad value in section 9.3 Alarm and events
- Event at;

It can be selected here that which of the events shall initiate an entry in the event log file of the flow computer and which of the events shall generate event in the alarm system. The options are:

 - lsc (low scale);
 - hsc (high scale);
 - lo (lo limit);
 - hi (hi limit);
 - lolo (lolo limit);
 - hihi (hihi limit);
- Log
- Eventing

Selecting *y* (*yes*) in the “Log” line causes an entry shall be generated in the log file.

Selecting *n* (*no*) in the Log line causes no entry is generated in the log file. In this case no *y* (*yes*) can be selected in the “Eventing” line.

If in the “Log” line *y* (*yes*) is selected, then in the “Eventing” line *y* (*yes*) or *n* (*no*) can be selected, i.e. the operator can decide if the event generates event in the alarm system or not.
- Live/check signal
 - live;
 - Hz; (enter check signal is Hz)
 - usec; (enter check signal is usec)
- Check signal; (displayed only if Live/check signal set to Hz or usec. This feature is provided for test purpose only. Do not forget to set the Live/check signal to “live” after the test to recover the normal operation of the flow computer.)
- Signal status
 - active;
 - inactive;

9.2.1.4 Pulse output channel

PITC4641 board has one pulse output channel.

The function of this channel is to transmit the pulses received on Flow pulse input channel.

These pulses transmitted to the Prover computer. This output is used in connection with the proving operation. See description of the proving operation in the Prover computer Instruction manual.

The operation mode of the pulse output channel is selected from the list as follows:

- AUTO

The operation of the pulse output controlled by the prover computer. This is the mode shall be selected when flow computer operates together with the prover computer.
- OFF

No pulse is transmitted via pulse output.
- PI Ch.1 ON

Pulses received on Channel 1 pulse input channel of the PITC4641 board will be transmitted via pulse output channel.
- PI Ch.2 ON

Pulses received on Channel 2 pulse input channel of the PITC4641 board will be transmitted via pulse output channel.
- PI Ch.3 ON

Pulses received on Channel 3 pulse input channel of the PITC4641 board will be transmitted via pulse output channel.
- PI Ch.4 ON

Pulses received on Channel 4 pulse input channel of the PITC4641 board will be transmitted via pulse output channel.

Function of the F keys on the pulse output channel data page

↓ select the next field for editing

↑ select the previous field for editing

Change modify the selected data field

OK Confirm the selection

Save save the selected/entered data and returns to the parent menu.

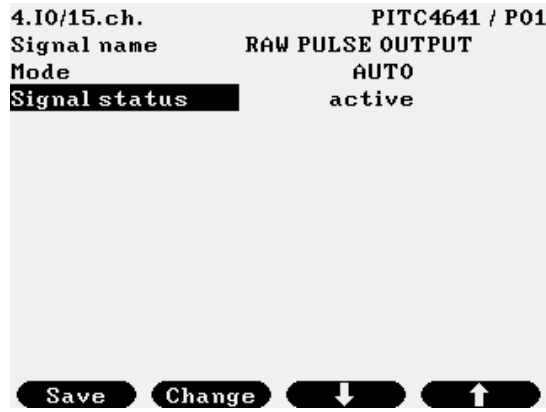

Figure 9-62 Pulse output channel data page

9.2.1.5 Digital input channel

Depending on the selected signal type of the digital (2-state) input the parameters and the data pages are different. The signal types are as follows:

- Dual state;
It is used to indicate two status of any equipment (for example valve) represented by an open and closed state of a contact.
- Pulse;
It is used to totalize the flow by counting low frequency (50 Hz maximum) pulse train from flow meter.

The data pages for each signal type show below.

Function of the F keys on the digital input channel data page

↓ select the next field for editing

↑ select the previous field for editing

Change modify the selected data field

OK Confirm the selection

Save save the selected/entered data and returns to the parent menu.

⇒ remove the highlighted item from the eventing list and step to the next item

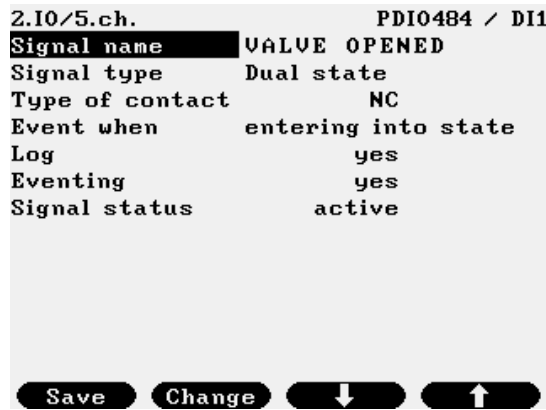

Figure 9-63 Digital input channel (signal type = dual state) data page

The editable fields on the data page are as follows:

- Signal name
Any character string up to 18 characters, for example: FV 501 valve status
- Signal type
 - Dual state;
- Type of contact
 - NO (normally open);
 - NC (normally closed);
- Event when
 - entering into state;
 - exiting from state;

- o at changing state;
- Log
 - o yes;
 - o no;
- Eventing; (generate event in the event log of the flow computer)
 - o yes;
 - o no;
- Signal status
 - o active;
 - o inactive;

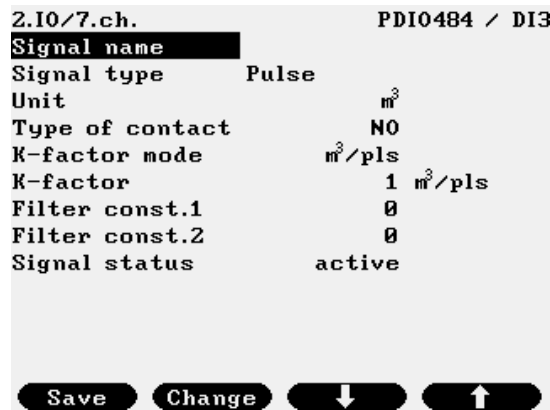

Figure 9-64 Digital input channel (signal type = pulse) data page

The editable fields on the data page are as follows:

- Signal name
Any character string up to 18 characters, for example: FIQ 501 pulse
- Signal type
 - o Pulse;
- Unit
 - o m³;
 - o kg;
 - o GJ;
 - o MWh;
 - o MVAh;
 - o MCF;
 - o lb;
 - o MMBTU;
 - o bbl;
 - o Mlb
- Type of contact
 - o NO (normally open);
 - o NC (normally closed);
- K-factor mode;
 - o pulse/unit (volume or mass or energy);
 - o unit/pulse;
- K-factor;
- Filter constant 1
- Filter constant 2

Filter constant are to apply digital filtering to the low frequency input signal. The goal of this filtering is to produce smoothly changing flow rate when the frequency of the input signal is lower then the frequency of the calculation cycle (which is 500 ms) in the flow computer.

0 < Filter constant < 1. If Filter constant = 0 then filter is switched off.

Recommended value for the filter constant depending on the time constant of the process is according to the table below:

Time constant (s)	Filter constant
1	0.3935
5	0.0952

10	0.0488
30	0.0165
60	0.0083

The smaller the filter constant the more accurate will be flow rate displayed but time required to achieve the final flow rate will take longer.

- Signal status
 - active;
 - inactive;

9.2.1.6 Digital output channel

Depending on the selected signal type of the digital (2-state) output channel the parameters and the data pages are different. The signal types are as follows:

- Pulse;
 - It is used to provide pulse output proportional to any total of any metering stream.
- STR FR alarm (stream flow rate alarm);
 - It is used to provide alarm output for any flow rate of any metering stream.
- STR fault alarm (stream in fault state);
 - It is used to provide alarm output for a particular stream if the stream is in fault state.
- Analog input alarm (for any analogue input);
 - It is used to provide alarm output for any analogue input signal limit.
- Digital input alarm (for any digital input);
 - It is used to provide alarm output for any digital input.
- Common alarm;
 - It is used to provide alarm output in case of general process alarm is active.
- Time base;
 - It is used to provide pulses as time base for any external equipment.
- Batch control;
 - It is used to control the batching process.

The data pages for each signal type show below.

Function of the F keys on the digital output channel data page

↓ select the next field for editing

↑ select the previous field for editing

Change modify the selected data field

OK Confirm the selection

Save save the selected/entered data and returns to the parent menu.

⇒ remove the highlighted item from the eventing list and step to the next item

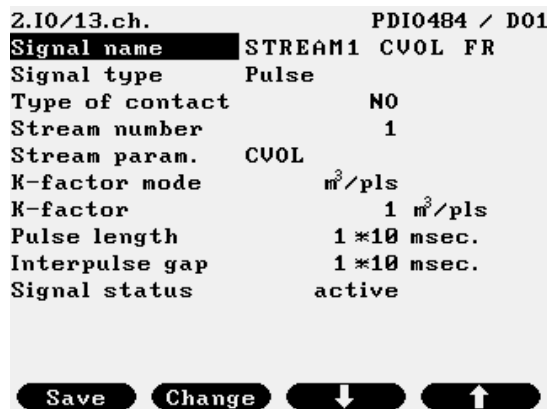

Figure 9-65 Digital output channel (signal type = pulse) data page

The editable fields on the data page are as follows:

- Signal name

- Any character string up to 18 characters, for example: FIQ 501 energy
- Signal type
 - Pulse;
- Type of contact
 - NO (normally open);
 - NC (normally closed);
- Stream number; (from 1 to 12)
- Stream parameter;
 - CVOL; (volume at base conditions);
 - UVOL; (volume at line conditions);
 - MASS (mass);
 - ENGY(energy);
- K-factor mode;
 - pulse/unit;
 - unit/pulse;
 - unit can be m³; kg or GJ depending on the stream parameter selected
- K-factor;
- Pulse length; (in 10 ms)
- Interpulse gap; (in 10 ms)
- Signal status
 - active;
 - inactive;

3.I0/13.ch.		PD10484 / D01
Signal name	STR 1 HI limit	
Signal type	STR FR alarm	
Stream number	1	
Type of contact	NO	
Event to alarm	- hi	
Delay	10 sec.	
Signal status	active	

Menu ↓ ↑

Figure 9-66 Digital output channel (signal type = STR FR alarm) data page

The editable fields on the data page are as follows:

- Signal name
Any character string up to 18 characters, for example: FIQ 501 CVOL FR
- Signal type
 - STR FR alarm;
- Stream number; (from 1 to 12)
The type of the flow rate (UVOL FR, CVOL FR, MASS FR, ENGY FR) and the value of the lolo, lo, hi, hihi limits are set in the stream definition section. See 9.2.2.1.5.
- Type of contact
 - NO (normally open);
 - NC (normally closed);
- Event to alarm;
It can be selected here that which of the events shall cause an alarm in the flow computer. The options are:
 - - (none)
 - lo (lo limit);
 - hi (hi limit);
 - lolo (lolo limit);
 - hihi (hihi limit);
- Type of contact
 - NO (normally open);
 - NC (normally closed);

- Delay; (in seconds)
- Signal status
 - active;
 - inactive;



Figure 9-67 Digital output channel (signal type = STR fault alarm) data page

The editable fields on the data page are as follows:

- Signal name
Any character string up to 18 characters, for example: FT001b
- Signal type
 - STR fault;
- Stream number; (from 1 to 12)
- Type of contact
 - NO (normally open);
 - NC (normally closed);
- Delay; (in seconds)
- Signal status
 - active;
 - inactive;



Figure 9-68 Digital output channel (signal type = Analog input alarm) data page

The editable fields on the data page are as follows:

- Signal name
Any character string up to 18 characters, for example: FIQ 501 temperature
- Signal type
 - Analog input alarm;
- Type of contact
 - NO (normally open);
 - NC (normally closed);

- Input signal I/O board X channel Y
- Event to alarm
 - lsc (low scale);
 - hsc (high scale);
 - lo (lo limit);
 - hi (hi limit);
 - lolo (lolo limit);
 - hihi (hihi limit);
- Delay; (in s)
- Signal status
 - active;
 - inactive;

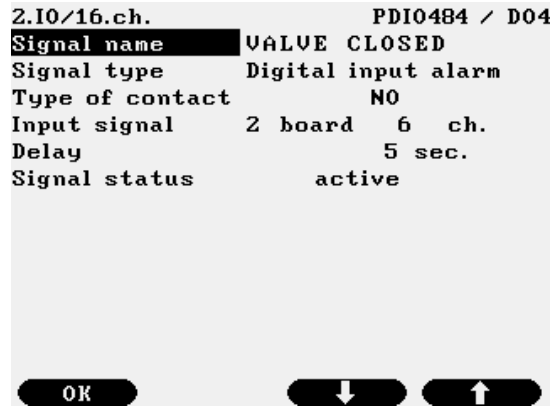

Figure 9-69 Digital output channel (signal type = Digital input alarm) data page

The editable fields on the data page are as follows:

- Signal name
Any character string up to 18 characters
- Signal type
 - Digital input alarm;
- Type of contact
 - NO (normally open);
 - NC (normally closed);
- Input signal I/O board X channel Y
- Delay; (in s)
- Signal status
 - active;
 - inactive;



Figure 9-70 Digital output channel (signal type = Common alarm) data page

The editable fields on the data page are as follows:

- Signal name
Any character string up to 18 characters, for example: COMMON alarm
- Signal type
 - Common alarm;
- Type of contact
 - NO (normally open);
 - NC (normally closed);
- Delay; (in seconds)
- Signal status
 - active;
 - inactive;



Figure 9-71 Digital output channel (signal type = Time base) data page

The editable fields on the data page are as follows:

- Signal name
Any character string up to 18 characters, for example: TIME BASE
- Signal type
 - Time base;
- Type of contact
 - NO (normally open);
 - NC (normally closed);
- Period time; (in seconds)
- Pulse length; (in seconds)
- Start at yy.mm.dd
 hh:mm
- Signal status
 - active;
 - inactive;

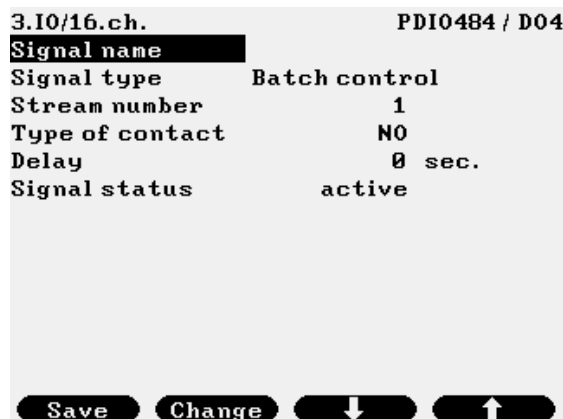

Figure 9-72 Digital output channel (signal type = Batch control) data page

The editable fields on the data page are as follows:

- Signal name
Any character string up to 18 characters, for example: LOADING
- Signal type
 - Batch control;
- Stream number (stream serial number the digital output is assigned to)
- Type of contact
 - NO (normally open);
 - NC (normally closed);
- Delay; (in seconds)
- Signal status
 - active;
 - inactive;

9.2.1.7 Analogue (4-20 mA) output channel

The analogue (4-20 mA) data page is shown on the figure below.

Function of the F keys on the analogue (4-20 mA) output channel data page

- ↓ select the next field for editing
- ↑ select the previous field for editing
- ⇒ remove the highlighted item from the eventing list and step to the next item

Change modify the selected data field

OK Confirm the selection

Save save the selected/entered data and returns to the parent menu.

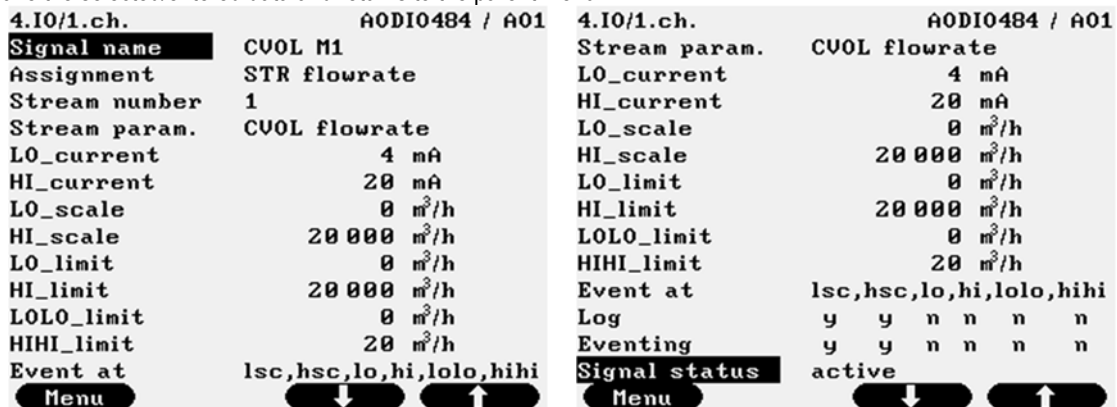

Figure 9-73 Analogue (4-20 mA) output channel data page

The editable fields on the data page are as follows:

- Signal name
Any character string up to 18 characters, for example: FIQ 501 flow rate
- Assignment
 - STR flowrate (stream flow rate);
 - Stream no;
 - Stream parameter;
 - CVOL FR; (volume flow rate at base conditions);
 - UVOL FR; (volume flow rate at line conditions);
 - MASS FR (mass flow rate);
 - ENGY FR (energy flow rate);
 - Linear gas velocity
 - Input signal;
 - Input signal X I/O board Y Channel
 - Modbus signal;
 - Channel X
 - PID CO (PID loop control output);
- LO_current (low scale of the current output);
- HI_current (high scale of the current output);
- LO_scale (low scale of the parameter in engineering unit);
- HI_scale (high scale of the parameter in engineering unit);

- LO_limit (low alarm limit);
- HI_limit (high alarm limit);
- LOLO_limit (low-low alarm limit);
- HIHI_limit (high-high alarm limit);
- Event at;

t can be selected here that which of the events shall initiate an entry in the event log file of the flow computer and which of the events shall generate event in the alarm system. The options are:

- o lsc (low scale);
- o hsc (high scale);
- o lo (lo limit);
- o hi (hi limit);
- o lololo (lolo limit);
- o hihi (hihi limit);

- Log
- Eventing

Selecting *y* (*yes*) in the “Log” line causes an entry shall be generated in the log file.

Selecting *n* (*no*) in the Log line causes no entry is generated in the log file. In this case no *y* (*yes*) can be selected in the “Eventing” line.

If in the “Log” line *y* (*yes*) is selected, then in the “Eventing” line *y* (*yes*) or *n* (*no*) can be selected, i.e. the operator can decide if the event generates event in the alarm system or not.

- Signal status
 - o active;
 - o inactive;

9.2.1.8 HART signal input channel

The HART signal input channel data page is shown on the figure below.

Function of the F keys on HART input channel data page

- ↓ select the next field for editing
- ↑ select the previous field for editing
- ⇒ remove the highlighted item from the eventing list and step to the next item

Change modify the selected data field

OK Confirm the selection

Save save the selected/entered data and returns to the parent menu.

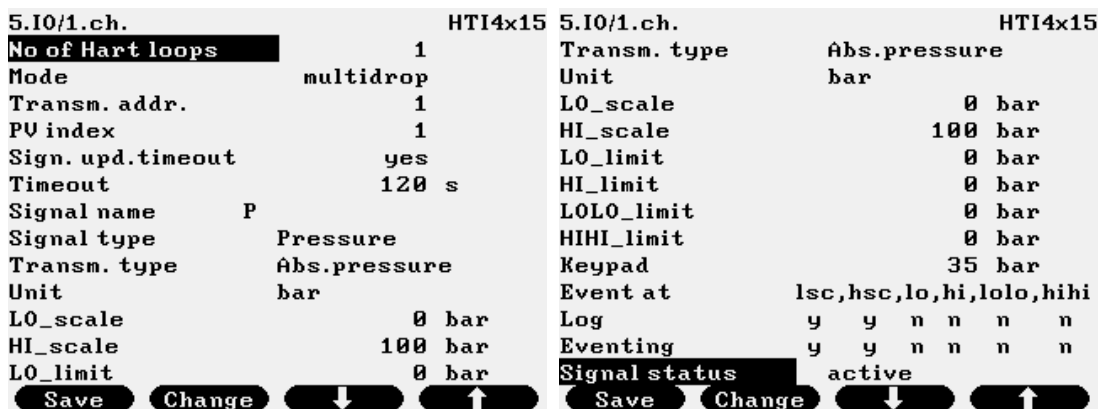

Figure 9-74 HART input channel data page

The editable fields on the data page are as follows:

- HART loop number; (from 1 to 4)
- Transmitter address; (from 0 to 15)
 If address 0 is selected then only one single transmitter can be connected on one loop. In this case transmitter provides both current output and HART output.
 If any address from 1 to 15 is selected then the transmitter signal available on HART only.
- PV index (from 1 to 4)
 The maximum number of PV indexes in one loop is 15.
 See details on the HART transmitter connections in Annex C.

- Signal update timeout
Selected from the list:
 - yes
 - no

If signal update timeout is set to no, then no signal update timeout will be checked. If signal is not updated then the last valid value will be used in the calculation without time limit.

If signal update timeout is set to yes, then the timeout in seconds shall be specified

- Timeout
Within the "timeout" time the last value of the HART signal will go to the calculation (last good value),
After the "timeout" time has expired and the signal still not updated
 - in case of non-flow signal (pressure, temperature) the keypad value of the signal goes to the calculation
 - in case of flow signal (differential pressure, flow rate) zero goes to the calculation

- Signal name
Any character string up to 18 characters, for example: FIQ 501 pressure

- Signal type

- Unit

- Supplementary parameter (depending on the signal type)
The signal type (type of the physical parameter measured at the channel), its unit of measurement and the supplementary parameter are selected from the list below:

- Differential pressure;
 - mbar
 - Pa
 - kPa
 - mmH2O
 - inH2O
- Flowrate;
 - m³/h
 - kg/h
 - GJ/h
 - MWh/h
 - MVA
 - MCF/h
 - lb/h
 - MMBTU/h
 - bbl/h
 - Mlb/h

supplementary parameter: Error curve

- yes
 - supplementary parameter 2: error curve correction type
 - linear interpolation,
 - UVOLFR (m³/h) - Error (%)
- no

5.I0/1.ch.		HTI4x15		5.I0/1.ch.		HTI4x15	
Error curve		linear interpolation					
		UVOLFR(m ³ /h)-Error(%)					
No.	flowrate		K				
1		0	0	4	0		0
2		0	0	5	0		0
3		0	0	6	0		0
4		0	0	7	0		0
5		0	0	8	0		0
6		0	0	9	0		0
7		0	0	10	0		0
8		0	0	11	0		0
9		0	0	12	0		0
10		0	0	13	0		0
				14	0		0
				15	0		0
				16	0		0

Figure 9-75 Error curve data page for flow rate signal

If the error curve correction is selected for the flow rate signal then new data page opens for entering the error curve points. The volume flow rate at line conditions (in m³/h) and the error (in %) at that flow rate shall be entered from the calibration certificate of the flow meter.

Maximum of 16 error curve point can be entered.

The flow rates shall be entered in increasing order.

- o Pressure;
 - bar
 - mbar
 - kPa
 - MPa
 - mmH₂O
 - PSIA or PSIG – depending on the gauge/absolute pressure transmitter selection
 supplementary parameter: type of transmitter
 - Gauge pressure
 - Abs. pressure
- o Temperature;
 - °C
 - °F
- o Density;
 - kg/m³
 - lb/CF
 - RD
 supplementary parameter: type of transmitter
 - Line density
 - Base density
 - Relative density (unit changes to – (none) for relative density)
- o Special (special signal);
 - %
 - mole%
 - (none)
 - MJ/m³
 - MJ/kg
 - uS
 - BTU/SCF
 - lb/MMSCF
- o Kin. viscosity (kinematic viscosity);
 - mm²/s
 - cSt
- o Level;
 - cm
 - m
 - mm
 - inch
 supplementary parameters
 - Level equivalent (in level unit/mA)
 - Zero level (in level unit)

Common parameters for input channels regardless of the signal type

- LO_current (low scale of the current input);
- HI_current (high scale of the current input);
- LO_scale (low scale of the parameter in engineering unit);
- HI_scale (high scale of the parameter in engineering unit);
- LO_limit (low alarm limit);
- HI_limit (high alarm limit);
- LOLO_limit (low-low alarm limit);
- HIHI_limit (high-high alarm limit);
- Keypad value; Keypad value is not available for differential pressure, flow rate and level signals. See the activation of the Keypad value in section 9.3. Alarm and events
- Event at;

It can be selected here that which of the events shall initiate an entry in the event log file of the flow computer and which of the events shall generate event in the alarm system. The options are:

- o lsc (low scale);
 - o hsc (high scale);
 - o lo (lo limit);
 - o hi (hi limit);
 - o lolo (lolo limit);
 - o hihi (hihi limit);
 - Log
 - Eventing
- Selecting *y* (*yes*) in the “Log” line causes an entry shall be generated in the log file.
 Selecting *n* (*no*) in the Log line causes no entry is generated in the log file. In this case no *y* (*yes*) can be selected in the “Eventing” line.
 If in the “Log” line *y* (*yes*) is selected, then in the “Eventing” line *y* (*yes*) or *n* (*no*) can be selected, i.e. the operator can decide if the event generates event in the alarm system or not.
- Signal status
 - o active;
 - o inactive;

IMPORTANT

If the signal configured for a channel is to be used in flow calculation, then the unit of measurement shall be selected as follows:
 In case of metric unit system:

- pressure signal: bar
- differential pressure signal: mbar
- temperature signal: °C

In case of imperial unit system for gas measurement:

- pressure signal: PSIG or PSIA
- differential pressure signal: inH2O
- temperature signal: °F

9.2.1.9 Modbus signal channel

There are 30 Modbus channels available in UNIFLOW-200. They can be configured as input channels

The Modbus channels can be used and shall be setup in the same way as the corresponding input channels. They can be written via the serial and Ethernet link of the flow computer.

The address range of the general purpose Modbus registers is 4000, 4002, 4004, ..., 4058 (30 registers). Data type to be written into these registers is 4 byte floating point data. See 10.4.3.4 for floating point data representation.

There are some special predefined Modbus registers used in the serial communication with the ultrasonic meters as follows:

- registers with address 2700 holds the volume flow rate at line conditions read from the ultrasonic meter on com 1 port;
- registers with address 2708 holds the volume flow rate at line conditions read from the ultrasonic meter on com 2 port;
- registers with address 2716 holds the volume flow rate at line conditions read from the ultrasonic meter on com 3 port;
- registers with address 2724 holds the volume flow rate at line conditions read from the ultrasonic meter on com 4 port;
- registers with address 2732 holds the volume flow rate at line conditions read from the ultrasonic meter on com 5 port;
- registers with address 2740 holds the volume flow rate at line conditions read from the ultrasonic meter on com 6 port;
- registers with address 2748 holds the volume flow rate at line conditions read from the ultrasonic meter on com 7 port;
- registers with address 2756 holds the volume flow rate at line conditions read from the ultrasonic meter on com 8 port;

The Modbus channels used as input channel for flow measurement with ultrasonic meters shall be setup to one of the above register addresses, depending on the com port the meter connected to.

Function of the F keys on the Modbus channel data page

- ⇩ select the next field for editing
- ⇩ select the previous field for editing
- ⇒ remove the highlighted item from the eventing list and step to the next item

Change modify the selected data field

OK Confirm the selection

Save save the selected/entered data and returns to the parent menu.

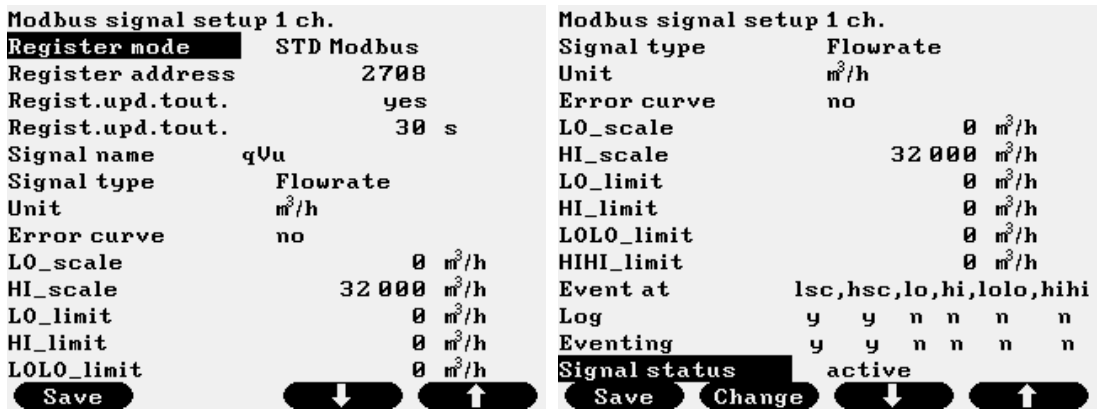

Figure 9-76 Modbus channel data page

The Modbus specific editable fields on the data page are as follows:

- Register address;
 - Register update timeout
- Selected from the list:
- yes
 - no

If register update timeout is set to no, then no register update timeout will be checked. If register is not updated then the last valid value will be used in the calculation without time limit.

If signal update timeout is set to yes, then the timeout in seconds shall be specified

- Timeout
- Within the “timeout” time the last value of the register will go to the calculation (last good value),
 After the “timeout” time has expired and the signal still not updated
- in case of non-flow signal (pressure, temperature) the keypad value of the signal goes to the calculation
 - in case of flow signal (differential pressure, flow rate) zero goes to the calculation

All of the other parameters for Modbus channels are identical with those of the corresponding input channels.

IMPORTANT

If the channel status is inactive then the channel cannot be used in the flow calculation even if you set all the parameters of the channel. Do not forget to set the channel active if you want to use the signal measured at the channel in the flow calculation.

9.2.2 Stream setup

After all the field I/O signals required for the particular application are setup and configured the metering streams should be setup. There are different procedure for setting up physical streams (streams measuring real fluid flow) and virtual streams (streams calculated from the flows of physical streams).

The stream setup in case of physical streams is done in four steps in four different submenus of the parameters menu.

First the fluid to be measured is selected and the physical properties of the fluid shall be defined.

In the second step the flow meter is selected and the parameters of the flow meter shall be entered.

In third step the field I/O signals assigned to the measured input parameters required for flow calculation.

In last step the premium limits are setup for the stream.

Setup procedure for the virtual stream includes the definition of the equation for the flow calculation and the setup of the premium limits.

Entering the physical stream menu item data page appears on the display. The serial number of the stream to be edited shall be selected and the identifier of the stream can be entered. The identifier is a 24 character long alphabetical string.

Note

The identifier of the stream will be part of the file name the archive data stored in.

9.2.2.1 Physical stream setup

Route in the menu tree:

Parameters	Streams	Physical stream
------------	---------	-----------------

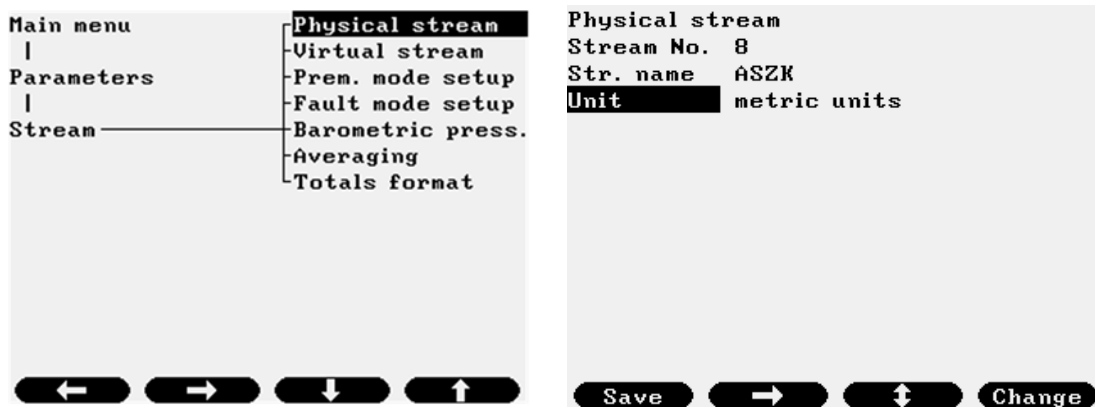

Figure 9-77 Stream selection data page

The system of units shall be selected on this page. Available selections are:

- o metric units;
- o imperial units;

Note:

If the "imperial units" is selected then the fluid selection shall be:

"Hydrocarbon mixture / Natural gas, Coke oven gas, Blast furnace gas" or
 "Liquid / Crude oil & products"

No other fluids are supported in imperial units.

In case of "imperial units" the base conditions can be selected as follows:

For gases:

- o base temperature = 59, 60 °F;
- o base pressure = 14.4, 14.5, 14.65, 14.696, 14.7, 14.73, 15.025 PSIA

For liquids:

- o base temperature = 60 °F;
- o base pressure = 0 PSIG

9.2.2.1.1 Fluid selection

After the stream is selected the fluid and its properties shall be defined.
 Depending on the fluid selected the fluid specific data page appears.
 The figures in this chapter explain the parameters of the different fluid to be defined and the options available for selection.

9.2.2.1.1.1 Fuel gases

There are three predefined fuel gases can be selected:

- o Natural gas;
- o Coke oven gas;
- o Blast furnace gas.

The data pages for each of them are shown in the paragraphs below.

9.2.2.1.1.1.1 Natural gas

Route in the menu tree:

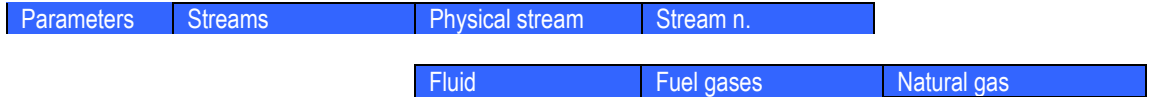

The natural gas data page is shown on the figure below.

Function of the F keys on the Natural gas data page

- ↓ select the next field for editing
- ↑ select the previous field for editing
- ⇒ enter into submenu for gas composition editing
- Change** modify the selected data field
- OK** Confirm the selection
- Save** save the selected/entered data and returns to the parent menu.

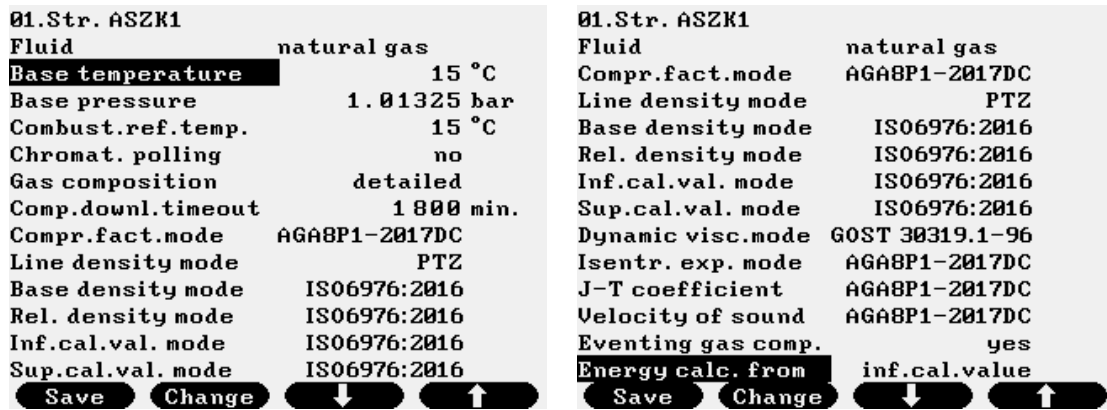

Figure 9-78 Natural gas data page (metric example)

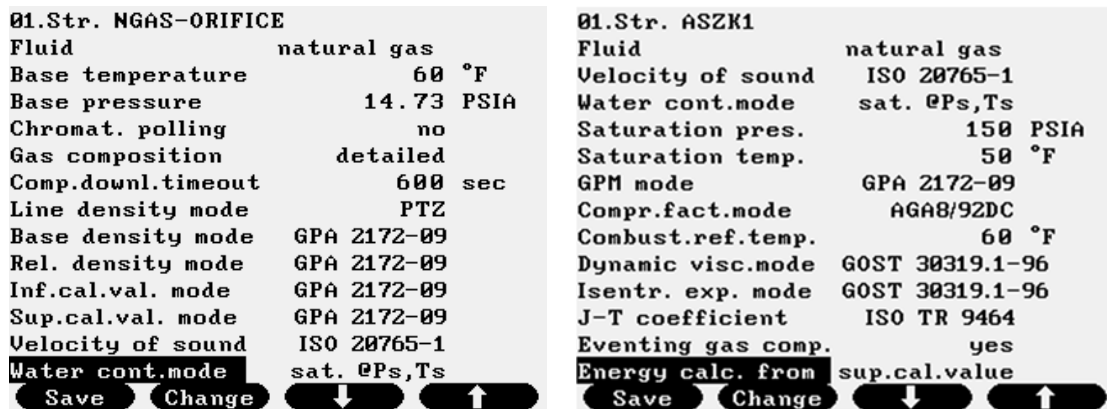

Figure 9-79 Natural gas data page (imperial example)

The data fields on the data page are as follows:

- **Base temperature;**
The base temperature selected from list
In metric units:
 - 15 °C;
 - 15.556 °C;
 - 20 °C;
 - 0 °C;
 In imperial units:
 - 59 °F;
 - 60 °F;
- **Base pressure;**
In metric units:
Not editable, fixed to 1.01325 bar
In imperial units:
 - 14.4 PSIA;
 - 14.5 PSIA;
 - 14.65 PSIA;
 - 14.696 PSIA;
 - 14.7 PSIA;
 - 14.73 PSIA;
 - 15.025 PSIA;
- **Combustion reference temperature;**
The combustion reference temperature selected from list
In metric units:
 - 15 °C;
 - 15.556 °C;
 - 20 °C;
 - 0 °C;
 In imperial units:
 - 60 °F;
 If 15.556 °C base temperature is selected, then the combustion reference temperature automatically set to 15.556 °C.
- **Chromatograph polling;**
 - no (no chromatograph polling is performed) ;
 - yes (chromatograph is polled for gas composition).
 NOTE: One of the serial port shall be connected to the gas chromatograph and the port function shall be set according to the type of the gas chromatograph to be polled.
See 9.2.4.1.
- **Gas composition;**
It shall be defined if the properties of the natural gas (density, compression factor, etc.) will be calculated from the detailed gas composition or from the limited set of gas composition. The options are:
 - detailed (gas composition) ;
21 components are assumed as defined in the AGA8-92 standard
 - limited (gas composition);
3 components (N2, CO2, H2) are assumed as defined in the GERG 88 standard and relative/base density and superior calorific value to be entered.

If detailed composition is selected new menu page appears allowing select data pages for entering detailed gas composition.

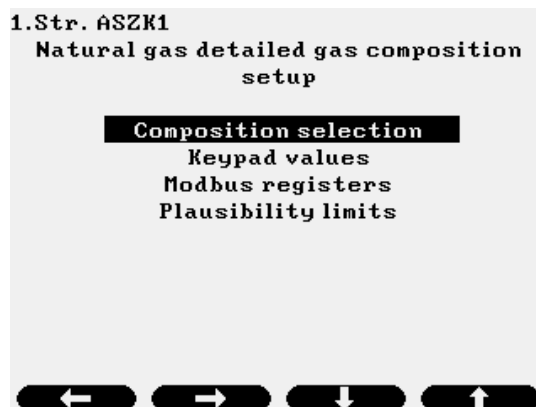

Figure 9-80 Natural gas detailed gas composition menu page

Selecting the menu items one by one data pages appear as follows.

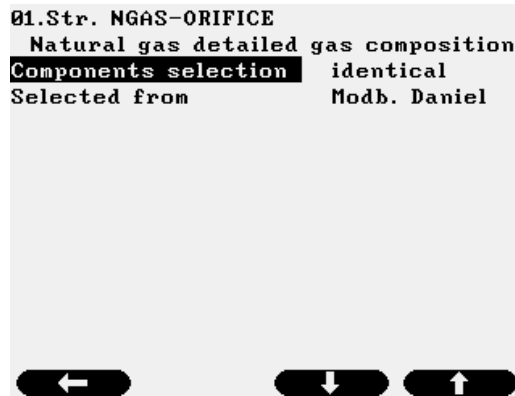

Figure 9-81 Natural gas composition selection data page

The data fields on the data page are as follows:

- Components selection; Reserved for future use
 - identical;
- Selected from;

The detailed gas composition used in the calculation can be selected from:

- Keypad value; The fixed values of the concentrations entered by the operator are used.
- Modb. Daniel; The gas composition is downloaded into the UNIFLOW-200 on Modbus link (serial or Ethernet) from supervisory system in Daniel/Enron/Omni format. The register formats and map see in the section 10 Communications.
- Modb. STD1; The gas composition is downloaded into the UNIFLOW-200 on Modbus link (serial or Ethernet) from supervisory system. The register formats and map, is shown in the section 10 Communications.
- Modb. STD2; The gas composition is downloaded into the UNIFLOW-200 on Modbus link (serial or Ethernet) from supervisory system. The register formats and map, is shown in the section 10 Communications.
- User Modbus; The gas composition is downloaded into the UNIFLOW-200 on Modbus link (serial or Ethernet) from supervisory system. The register formats and map are according to User Modbus table.

01.Str. NGAS-ORIFICE				01.Str. NGAS-ORIFICE			
Natural gas detailed gas composition				Natural gas detailed gas composition			
keypad (mole%)		Total: 100.0001		keypad (mole%)		Total: 100.0001	
N2	0.7632	npentane	0.0098	ammonia	0	air	0
CO2	0.0489	nhexane	0.0196	benzene	0		
H2S	0	nheptane	0	dimet-prop-22	0		
H2O	0.1996	noctane	0	met-pent-2	0		
helium	0	nnonane	0	met-pent-3	0		
methane	95.8377	ndecane	0	dimet-but-22	0		
ethane	0.7925	oxygen	0	dimet-but-23	0		
propane	0.2642	CO	0	ethylene	0		
ibutane	0.0489	H2	1.9569	propylene	0		
nbutane	0.0489	argon	0	meth-alcohol	0		
ipentane	0.0098	Other components		sulf-dioxid	0		

Figure 9-82 Natural gas keypad composition data page

Keypad concentration of the 21 components can be entered on this page.

The name of the components abbreviated as follows:

- N2 nitrogen
- CO2 carbon-dioxide
- H2S hydrogen-sulfide
- H2O water

He	helium
C1	methane
C2	ethane
C3	propane
nC4	n-butane
iC4	i-butane
nC5	n-pentane
iC5	i-pentane
nC6	n-hexane
nC7	n-heptane
nC8	n-octane
nC9	n-nonane
nC10	n-decane
O2	oxygen
CO	carbon-monoxide
H2	hydrogen
Ar	argon

Beside the 21 components from AGA8 additional components from AGA5 and GPA 2172 can be entered as follows

ammonia	Ammonia
benzene	Benzene
dimet-propan-22	22-Dimethyl Propan
met-pent-2	2-Methyl Pentane
met-pent-3	3-Methyl Pentane
dimet-but-22	22-Dimethyl Butane
dimet-but-23	23-Dimethyl Butane
ethylene	Ethylen
propylen	Propylene
meth-alcohol	Methyl Alcohol
sulf-dioxid	Sulfur Dioxide
air	Air

The sum of the entered mole percentage must be in the 95 % - 105 % range. If the sum is outside this range, then the composition is rejected.

If the sum is inside the 95 % - 105 % range then UNIFLOW-200 performs normalization on the concentration and the normalized concentration is stored as keypad values.

The sum of the mole concentrations is checked on the downloaded composition also and the normalization is done if necessary.

01.Str. NGAS-ORIFICE			
Components slave modbus registers			
N2	7 001	nhexane	7 013
CO2	7 002	nheptane	7 014
H2S	7 003	noctane	7 015
H2O	7 004	nnonane	7 016
helium	7 005	ndecane	7 017
methane	7 006	oxygen	7 018
ethane	7 007	CO	7 019
propane	7 008	H2	7 020
nbutane	7 009	rel.dens.	7 021
ibutane	7 010	Inf. cal. value	7 022
npentane	7 011	sup.cal.value	7 023
ipentane	7 012	argon	7 024

Figure 9-83 Natural gas Modbus registers data page

The Modbus registers for the 21 components and for the relative density, inferior calorific value and superior calorific value are displayed here.

The page is read only.

If limited composition is selected data page appears allowing enter the concentration of the nitrogen, carbon-dioxide and hydrogen.

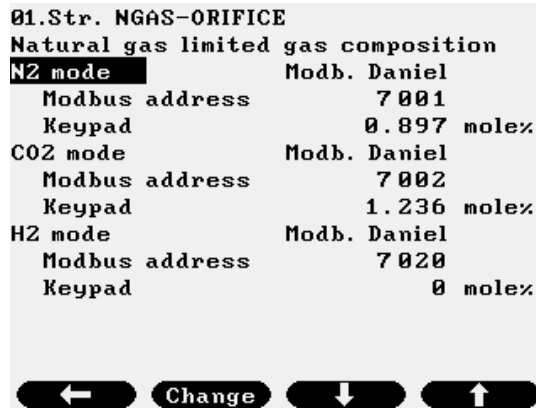

Figure 9-84 Natural gas limited gas composition data page

The data fields on the data page are as follows:

- N2 mode;
 - Select the source of the nitrogen concentration from the list:
 - Keypad value;
 - The fixed value of the concentration entered by the operator is used.
 - Selecting “keypad” data entry field appears to enter the keypad value.
 - N2mol%
 - measured;
 - Signal representing the concentration is measured on input channel (analog or Modbus or Hart). One channel in I/O signal setup section should be configured as “Special” signal type with mole % unit.
 - Modb. Daniel;
 - Concentration is received as data on Modbus link in Daniel/Enron/Omni format.
 - Selecting “Modb. Daniel” data entry fields appear to enter the Modbus register
 - N2 mole% modbus register; (register address where the concentration is downloaded)
 - Modb. STD1;
 - Concentration is received as data on Modbus link in Modb. STD1 format.
 - Selecting “Modb. STD1” data entry fields appear to enter the Modbus register
 - N2 mole% modbus register; (register address where the concentration is downloaded)
 - Modb. STD2;
 - Concentration is received as data on Modbus link in Modb. STD2 format.
 - Selecting “Modb. STD2” data entry fields appear to enter the Modbus register
 - N2 mole% modbus register; (register address where the concentration is downloaded)
- CO2 mode;
- H2 mode;
- Data fields for CO2 mode and H2 mode identical with those for N2 mode.
- Comp. downl. timeout (Gas composition download timeout);

If the gas composition selection set to Modb. Daniel, Modb. STD1 or Modb. STD2 and no new gas composition is received within the timeout specified here then alarm is raised and the keypad gas composition will be used in the calculation. The timeout entry is limited to 60 000 minutes (approx.. 42 days).

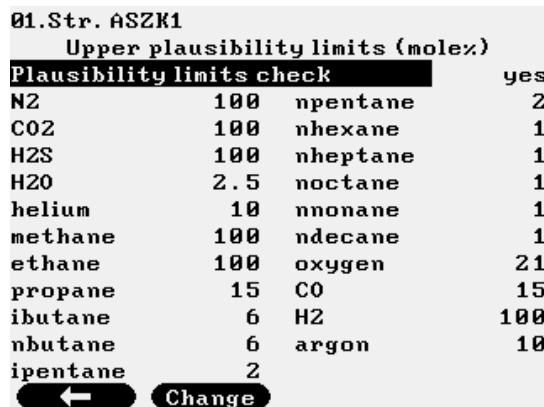

Figure 9-85 Natural gas plausibility limits data page

The data fields on the data page are as follows:

- Plausibility limit check;
 - yes
 - no;

If “yes” is selected, the gas composition received from any sources (read from gas chromatograph, downloaded via Modbus link, entered as fixed value) will be checked against the upper plausibility limits listed on the data page.

If any of the components is outside the limit the whole set of gas composition will be rejected (not only the component outside the limit) and the previous valid gas composition will be used in the calculation.

If “no” is selected, no such plausibility limit check will be performed.

The operator cannot change the numerical values of the plausibility limits.

Caution!

Turning off the plausibility check and entering gas composition outside the plausibility limits, above certain pressure and below certain temperature may lead to instability in calculation (especially in compression factor and line density calculations) or these calculations may fail.

Turn it off with special care only.

- Compression factor mode;

The mode for the compression factor determination is selected here from the list as follows:

- AGA8-92DC
Compression factor is calculated according to the AGA8-92DC equation from the detailed gas composition.
- AGA8-92Gr1
Compression factor is calculated according to the AGA8-92 Gross method 1 from the superior calorific value, relative density and CO2 content.
The H2 and CO are taken into the calculation as described in SGERG TM5 1991.
If AGA8-92Gr1 is selected entry field opens to enter the combustion reference temperature. It is selected from the list 0, 15, 20, 25 °C.
- AGA8-92Gr2
Compression factor is calculated according to the AGA8-92 Gross method 2 from the relative density, CO2 and N2 content.
The H2 and CO are taken into the calculation as described in SGERG TM5 1991.
- SGERG88
Compression factor is calculated according to the SGERG 88 according to ISO 12213-3 from the base density, superior calorific value, CO2 and H2 content.
- GERG91mod (available in metric units only)
Compression factor is calculated according to the GOST 30319.2-96 from the base density, CO2 and N2 content. In case of GERG91mod selection the base temperature is automatically set to 20 °C
- NX19mod (available in metric units only)
Compression factor is calculated according to the GOST 30319.2-96 from the base density, CO2 and N2 content. In case of NX19mod selection the base temperature is automatically set to 20 °C
- VNIC SMV (available in metric units only)
Compression factor is calculated according to the GOST 30319-2-96 from the detailed gas composition.
- AGA NX19
Compression factor is calculated according to the AGA NX19 from the relative density, CO2 and N2 content.
- Z keypad The operator entered keypad value is used in the flow calculation.
If Z keypad is selected then two entry fields open to enter the base compression factor and line compression factor keypad values.
- AGA8/85
Compression factor is calculated according to the AGA8 1985 edition from the detailed gas composition.
- GOST 30319.2-2015
Compression factor is calculated according to the GOST 30319-2.2015 standard from the base density, CO2 and N2 content.
- GOST 30319.3-2015
Compression factor is calculated according to the GOST 30319-3.2015 standard from the detailed gas composition.
- AGA8 Part2-2017
Compression factor is calculated according to the AGA Report No.8 Part 2 April 2017 (GERG-2008 Equation of State) from the detailed gas composition.
- AGA8 P1-2017 DC
Compression factor is calculated according to the AGA Report No.8 Part 1 April 2017 (DETAIL Equation of State) from the detailed gas composition.
- AGA8 P1-2017 Gr-M0
Compression factor is calculated according to the AGA Report No.8 Part 1 April 2017 (GROSS Equation of State, Method 0) from the detailed gas composition.

- AGA8 P1-2017 Gr-M1
Compression factor is calculated according to the AGA Report No.8 Part 1 April 2017 (GROSS Equation of State, Method 1) from the relative density, gross calorific value and CO2 content.
- AGA8 P1-2017 Gr-M2
Compression factor is calculated according to the AGA Report No.8 Part 1 April 2017 (GROSS Equation of State, Method 2) from the relative density, CO2 and N2 content.
- AGA8 P1-2017 Gr-M3
Compression factor is calculated according to the AGA Report No.8 Part 1 April 2017 (GROSS Equation of State, Method 3) from the detailed gas composition.
- Line density mode;
The mode for the line density determination is selected here from the list as follows:
 - PTZ
Line density calculated from the base density with pressure, temperature and compression factor correction.
 - AGA7
Line density calculated from the base density with pressure, temperature and compression factor correction as defined in AGA7.
 - AGA8/92DC
Line density is taken from the AGA8/92DC calculation.
 - keypad
The operator entered keypad value is used in the flow calculation.
If keypad is selected entry field opens to enter the keypad value.
 - GOST 30319.2-2015
Line density is calculated according to the GOST 30319-2.2015 standard.
 - GOST 30319.3-2015
Line density is calculated according to the GOST 30319-3.2015 standard.
 - AGA8 Part2-2017
Line density is calculated according to the AGA Report No.8 Part 2 April 2017 (GERG-2008 Equation of State) from the detailed gas composition.
 - AGA8 P1-2017 DC
Line density is calculated according to the AGA Report No.8 Part 1 April 2017 (DETAIL Equation of State) from the detailed gas composition.
 - measured
Signal representing the line density is measured on input channel. One channel in I/O signal setup section should be configured as "Line density" signal type.
 - Modb. Daniel
Line density is received as data on Modbus link in Daniel/Enron/Omni format.
If Modb. Daniel is selected entry field opens to enter the keypad value.
This keypad value will be used in calculation if no data received within the timeout time.
 - Modb. STD2
Line density is received as data on Modbus link in Modb. STD2 data format.
If Modb. STD2 is selected entry field opens to enter the keypad value.
This keypad value will be used in calculation if no data received within the timeout time.
- Base density mode;
The mode for the base density determination is selected here from the list as follows:
 - measured
Signal representing the base density is measured on input channel. One channel in I/O signal setup section should be configured as "Base density" signal type.
 - Calc. from rel. (calculated from relative density)
Base density is calculated from Relative density
 - Modb. Daniel
Base density is received as data on Modbus link in Daniel/Enron/Omni format.
If Modb. Daniel is selected entry field opens to enter the keypad value.
This keypad value will be used in calculation if no data received within the timeout time.
 - keypad
The operator entered keypad value is used in the flow calculation.
If keypad is selected entry field opens to enter the keypad value.
 - ISO6976:1995
Base density is calculated from the detailed gas composition according to ISO 6976:1995 standard.
 - ISO6976:2016
Base density is calculated from the detailed gas composition according to ISO 6976:2016 standard.
 - Modb. STD2
Base density is received as data on Modbus link in Modb. STD2 format.

- If `Modb. STD2` is selected entry field opens to enter the keypad value.
 - This keypad value will be used in calculation if no data received within the timeout time.
 - `GOST 30319.1-96` (available in metric units only)
 - Base density is calculated from the detailed gas composition according to GOST 30319.1-96 standard.
 - In case of GOST 30319.1-96 selection the base temperature is automatically set to 20 °C.
 - `GPA 2172-09` (available in imperial units only)
 - Base density is calculated from the detailed gas composition according to GPA 2172-09.
- Relative density mode;
 - The mode for the relative density determination is selected here from the list as follows:
 - `ISO6976:1995`
 - Relative density is calculated from the detailed gas composition according to ISO6976:1995 standard.
 - `ISO6976:2016`
 - Relative density is calculated from the detailed gas composition according to ISO6976:2016 standard.
 - `AGA5`
 - Relative density is calculated from the detailed gas composition according to AGA5.
 - `GPA 2172-09` (available in imperial units only)
 - Relative density is calculated from the detailed gas composition according to GPA 2172-09.
 - `measured`
 - Signal representing the relative density is measured on input channel. One channel in I/O signal setup section should be configured as "Relative density" signal type.
 - `Calc. from base` (Calculated from Base density)
 - Relative density is calculated from Base density
 - `Modb. Daniel`
 - Relative density is received as data on Modbus link in Daniel/Enron/Omni format.
 - If `Modb. Daniel` is selected entry field opens to enter the keypad value.
 - This keypad value will be used in calculation if no data received within the timeout time.
 - `Modb. STD1`
 - Relative density is received as data on Modbus link in Modb. STD1 format.
 - If `Modb. STD1` is selected entry field opens to enter the keypad value.
 - This keypad value will be used in calculation if no data received within the timeout time.
 - `Modb. STD2`
 - Relative density is received as data on Modbus link in Modb. STD2 format.
 - If `Modb. STD2` is selected entry field opens to enter the keypad value.
 - This keypad value will be used in calculation if no data received within the timeout time.
 - `keypad`
 - The operator entered keypad value is used in the flow calculation.
 - If `keypad` is selected entry field opens to enter the keypad value.
- Inferior calorific value mode;
 - The mode for the inferior calorific value determination is selected here from the list as follows:
 - `ISO6976:1995`
 - Inferior calorific value is calculated from the detailed gas composition according to ISO6976:1995 standard.
 - `ISO6976:2016`
 - Inferior calorific value is calculated from the detailed gas composition according to ISO6976:2016 standard.
 - `GOST 30319.1-96` (available in metric units only)
 - Inferior calorific value is calculated from the detailed gas composition according to GOST 30319.1-96 standard.
 - `AGA5`
 - Inferior calorific value is calculated from the detailed gas composition according to AGA5.
 - `GPA 2172-09` (available in imperial units only)
 - Inferior calorific value is calculated from the detailed gas composition according to GPA 2172-09.
 - `measured`
 - Signal representing the inferior calorific value is measured on input channel. One channel in I/O signal setup section should be configured as "Inferior calorific value" signal type.
 - `Modb. Daniel`
 - Inferior calorific value is received as data on Modbus link in Daniel/Enron/Omni format.
 - If `Modb. Daniel` is selected entry field opens to enter the keypad value.
 - This keypad value will be used in calculation if no data received within the timeout time.
 - `Modb. STD1`
 - Inferior calorific value is received as data on Modbus link in Modb. STD1 format.
 - If `Modb. STD1` is selected entry field opens to enter the keypad value.
 - This keypad value will be used in calculation if no data received within the timeout time.
 - `Modb. STD2`
 - Inferior calorific value is received as data on Modbus link in Modb. STD2 format.
 - If `Modb. STD2` is selected entry field opens to enter the keypad value.

- This keypad value will be used in calculation if no data received within the timeout time.
 - keypad
 - The operator entered keypad value is used in the flow calculation
- Superior calorific value mode;

The mode for the superior calorific value determination is selected here from the list as follows:

 - ISO6976:1995
 - Superior calorific value is calculated from the detailed gas composition according to ISO6976:1995 standard.
 - ISO6976:2016
 - Superior calorific value is calculated from the detailed gas composition according to ISO6976:2016 standard.
 - GOST 30319.1-96 (available in metric units only)
 - Superior calorific value is calculated from the detailed gas composition according to GOST 30319-1.
 - AGA5
 - Inferior calorific value is calculated from the detailed gas composition according to AGA5.
 - GPA 2172-09 (available in imperial units only)
 - Superior calorific value is calculated from the detailed gas composition according to GPA 2172-09.
 - measured
 - Signal representing the superior calorific value is measured on input channel.
 - One channel in I/O signal setup section should be configured as "Superior calorific value" signal type.
 - Modb. Daniel
 - Superior calorific value is received as data on Modbus link in Daniel/Enron/Omni format.
 - If Modb. Daniel is selected entry field opens to enter the keypad value.
 - This keypad value will be used in calculation if no data received within the timeout time.
 - Modb. STD2
 - Superior calorific value is received as data on Modbus link in Modb. STD2 format.
 - If Modb. STD2 is selected entry field opens to enter the keypad value.
 - This keypad value will be used in calculation if no data received within the timeout time.
 - keypad
 - The operator entered keypad value is used in the flow calculation
- Dynamic viscosity mode;

The mode for the dynamic viscosity determination is selected here from the list as follows:

 - GOST 30319.1-96
 - Dynamic viscosity calculated from the base density, N2 and CO2 content, pressure and temperature according to GOST 30319.1-96
 - GOST 30319.2-2015
 - Dynamic viscosity calculated from the base density, N2 and CO2 content, pressure and temperature according to GOST 30319.2-2015
 - GOST 30319.3-2015
 - Dynamic viscosity calculated from the detailed gas composition, pressure and temperature according to GOST 30319.3-2015
 - keypad
 - The operator entered keypad value is used in the flow calculation.
- Isentropic exponent mode;

The mode for the isentropic exponent determination is selected here from the list as follows:

 - GOST 30319.1-96
 - Isentropic exponent is calculated from the base density, CO2 content, pressure and temperature according to GOST 30319.1-96
 - ISO 20765-1
 - Isentropic exponent is calculated according to ISO 20765-1 from the detailed gas composition.
 - GOST 30319.2-2015
 - Isentropic exponent is calculated from the base density, CO2 content, pressure and temperature according to GOST 30319.2-2015
 - GOST 30319.3-2015
 - Isentropic exponent is calculated from the detailed gas composition, pressure and temperature according to GOST 30319.3-2015
 - AGA8 Part2-2017
 - Isentropic exponent is calculated according to the AGA Report No.8 Part 2 April 2017 (GERG-2008 Equation of State) from the detailed gas composition.
 - AGA8 P1-2017 DC
 - Isentropic exponent is calculated according to the AGA Report No.8 Part 1 April 2017 (DETAIL Equation of State) from the detailed gas composition.
 - keypad

The operator entered keypad value is used in the flow calculation

- Joule-Thomson coefficient mode;
The mode for the Joule-Thomson coefficient determination is selected here from the list as follows:
 - ISO TR 9464
Joule-Thomson coefficient is calculated from the pressure and temperature according to ISO TR 9464
 - ISO 20765-1
Joule-Thomson coefficient is calculated according to ISO 20765-1 from the detailed gas composition.
 - AGA8 Part2-2017
Joule-Thomson coefficient is calculated according to the AGA Report No.8 Part 2 April 2017 (GERG-2008 Equation of State) from the detailed gas composition.
 - AGA8 P1-2017 DC
Joule-Thomson coefficient is calculated according to the AGA Report No.8 Part 1 April 2017 (DETAIL Equation of State) from the detailed gas composition.
 - keypad
The operator entered keypad value is used in the flow calculation

- Velocity of sound mode;
The mode for the velocity of sound determination is selected here from the list as follows:
 - ISO 20765-1
Velocity of sound is calculated from the detailed gas composition according to ISO 20765-1
 - GOST 30319.1-96
Velocity of sound is calculated according to GOST 30319.1-96.
 - GOST 30319.2-2015
Velocity of sound is calculated according to GOST 30319.2-2015.
 - GOST 30319.3-2015
Velocity of sound is calculated according to GOST 30319.3-2015.
 - AGA8 Part2-2017
Velocity of sound is calculated according to the AGA Report No.8 Part 2 April 2017 (GERG-2008 Equation of State) from the detailed gas composition.
 - AGA8 P1-2017 DC
Velocity of sound is calculated according to the AGA Report No.8 Part 1 April 2017 (DETAIL Equation of State) from the detailed gas composition.
 - keypad
The operator entered keypad value is used.

- Water content mode (available in imperial units only);
If any of the Relative density mode, Base density mode, Inferior calorific value mode or Superior calorific value mode is selected as GPA 2172-2009, then the water content mode shall be selected from the list as follows:
 - dry
Water content is assumed to be 0.
 - saturated @ Ps,Ts
It is assumed that the natural gas is saturated with water at saturation pressure Ps and saturation temperature Ts. The concentration of the water is calculated according to GPA 2172-2009. Entry fields for saturation pressure and temperature are opened here.
 - Saturation pressure;
 - Saturation temperature;
 - saturated @ Pn,Tn
It is assumed that the natural gas is saturated with water at base pressure Pn and base temperature Tn. The concentration of the water is calculated according to GPA 2172-2009.
 - measured
Signal representing the water content value in lbmmscf is measured on input channel. One channel in I/O signal setup section should be configured as "Special" signal type. The unit of measurement for that special signal shall be lbmmscf.
 - keypad
The operator entered keypad value is used in the flow calculation. Entry field opens here for keypad value of the water content.
 - keypad value
 - Modbus signal
Signal representing the water content value in lbmmscf is measured on Modbus input channel. One Modbus channel in I/O signal setup section should be configured as "Special" signal type. The unit of measurement for that special signal shall be lbmmscf.

- GPM mode (available in imperial units only);

If any of the Relative density mode, Base density mode, Inferior calorific value mode or Superior calorific value mode is selected as GPA 2172-2009, then the GMP mode shall be selected from the list as follows:

- o GPA 2172-2009

The GPM (liquid equivalent) of the natural gas is calculated according to GPA 2172-2009.

- Eventing gas composition limits;
It is operator selectable if the gas composition limits given in Tables 9-2 and Table 9-3 will generate limit alarms and entries in the event log or not.
 - o yes
 - o no

Energy calculation from;

It is operator selectable if the energy flow rate of the natural gas stream shall be calculated from inferior or superior calorific value.

- o superior calorific value;
- o inferior calorific value;

NOTE

The available modes of the natural gas properties listed above depends on that if the detailed or limited set of gas composition is given. There is also an interlock in the base and relative density selections.

The Table 9.1. below summarizes the possible modes of the properties.

Table 9.2. and Table 9.3. give the nominal and expanded ranges of gas mixture characteristics for compression factor calculation from detailed and limited set of gas composition.

If the gas mixture characteristics are outside the nominal range but inside the expanded range UNIFLOW-200 generates alarm (if eventing is enabled) but continue the calculation.

Outside the expanded range UNIFLOW-200 generates alarm in any case and tries to continue the compression factor calculation. If due to extreme gas composition the compression factor calculation fails alarm is generated and the last valid calculated compression factor will be used in the flow calculation.

In case of limited gas composition the properties entered must belong to real natural gas. Entering arbitrary calorific value, relative density, CO2 and N2 content may lead to calculation failure (convergence error) in the AGA8-92Gr1 and Gr2 calculation.

	If the gas composition is given as			
	detailed gas composition		limited set of gas composition	
	AND Base density mode NOT from Relative density then	AND Base density mode IS from Relative density then	AND Base density mode NOT from Relative density then	AND Base density mode IS from Relative density then
Relative density modes	- measured - Calc. from base - Modb. Daniel - Modb. STD1 - Modb. STD2 - keypad - ISO6976:1995 - ISO6976:2016 - AGA5 - GPA 2172-09 (imperial only)	- measured - Modb. Daniel - Modb. STD1 - Modb. STD2 - keypad - ISO6976:1995 - ISO6976:2016 - AGA5 - GPA 2172-09 (imperial only)	- measured - Calc. from base - Modb. Daniel - Modb. STD1 - Modb. STD2 - keypad	- measured - Modb. Daniel - Modb. STD1 - Modb. STD2 - keypad
	AND Relative density mode NOT from Base density then	AND Relative density mode IS from Base density	AND Relative density mode NOT from Base density then	AND Relative density mode IS from Base density
Base density modes	- measured - Calc. from rel. - Modb. Daniel - keypad - ISO6976:1995 - ISO6976:2016 - Modb. STD2	- measured - Modb. Daniel - keypad - ISO6976:1995 - ISO6976:2016 - Modb. STD2	- measured - Calc. from rel. - Modb. Daniel - Modb. STD2 - keypad	- measured - Modb. Daniel - Modb. STD2 - keypad

	<ul style="list-style-type: none"> - GOST 30319.1-96 (metric only) - GPA 2172-09 (imperial only) 	<ul style="list-style-type: none"> - GOST 30319.1-96 (metric only) - GPA 2172-09 (imperial only) 		
Inferior calorific value modes	<ul style="list-style-type: none"> - measured - Modb. Daniel - Modb. STD1 - Modb. STD2 - keypad - ISO6976:1995 - ISO6976:2016 - GOST 30319.1-96 (metric only) - AGA5 - GPA 2172-09 (imperial only) 		<ul style="list-style-type: none"> - measured - Modb. Daniel - Modb. STD1 - Modb.. STD2 - keypad 	
Superior calorific value modes	<ul style="list-style-type: none"> - measured - Modb. Daniel - Modb. STD2 - keypad - ISO6976:1995 - ISO6976:2016 - GOST 30319.1-96 (metric only) - AGA5 - GPA 2172-09 (imperial only) 		<ul style="list-style-type: none"> - measured - Modb. Daniel - Modb. STD2 - keypad 	
Compression factor modes	<ul style="list-style-type: none"> - AGA 8/92DC - AGA 8/92Gr1 - AGA 8/92Gr2 - SGERG 88 - GERG91mod (metric only) - NX19mod (metric only) - VNIC SMV (metric only) - AGA NX19 - Z keypad - AGA 8/85 - GOST 30319.2-2015 - GOST 30319.3-2015 - AGA8 Part2-2017 - AGA8 P1-2017 DC - AGA8 P1-2017 Gr -M0 - AGA8 P1-2017 Gr-M1 - AGA8 P1-2017 Gr-M2 - AGA8 P1-2017 Gr-M3 		<ul style="list-style-type: none"> - AGA8/92Gr1 - AGA8/92Gr2 - SGERG 88 - GERG91mod (metric only) - NX19mod (metric only) - AGA NX19 - Z keypad - GOST 30319.2-2015 - AGA8 P1-2017 Gr-M1 - AGA8 P1-2017 Gr-M2 	
Line density modes	<ul style="list-style-type: none"> - PTZ - AGA7 - AGA8/92DC (Note 1) - keypad - GOST 30319.2-2015 (metric only) - GOST 30319.3-2015 (metric only, Note 1) - AGA8 Part2-2017 - AGA8 P1-2017 DC - measured - Modb. Daniel - Modb. STD2 		<ul style="list-style-type: none"> - PTZ - AGA7 - keypad - GOST 30319.2-2015 (metric only) - measured - Modb. Daniel - Modb. STD2 	
Dynamic viscosity mode	<ul style="list-style-type: none"> - GOST 30319.1-96 (metric only) - GOST 30319.2-2015 (metric only) - GOST 30319.3-2015 (metric only, Note 1) - keypad 		<ul style="list-style-type: none"> - GOST 30319.1-96 (metric only) - GOST 30319.2-2015 (metric only) - keypad 	
Isentropic exponent mode	<ul style="list-style-type: none"> - GOST 30319.1-96 (metric only) - ISO 20765-1 - GOST 30319.2-2015 (metric only) - GOST 30319.3-2015 (metric only, Note 1) - AGA8 Part2-2017 - AGA8 P1-2017 DC 		<ul style="list-style-type: none"> - GOST 30319.1-96 (metric only) - GOST 30319.2-2015 (metric only) - keypad 	

	- keypad	
Joule-Thomson coefficient mode	- ISO 20765-1 - ISO TR 9464 - AGA8 Part2-2017 - AGA8 P1-2017 DC - keypad	- ISO TR 9464 - keypad
Velocity of sound mode	- ISO 20765-1 - GOST 30319.1-96 (metric only) - GOST 30319.2-2015 (metric only) - GOST 30319.3-2015 (metric only, Note 1) - AGA8 Part2-2017 - AGA8 P1-2017 DC - keypad	- GOST 30319.1-96 (metric only) - GOST 30319.2-2015 (metric only) - keypad

Note 1 Available only if "Compression factor mode" is AGA8/92DC or GOST 30319.3-2015.

The data page for coke oven gas composition is shown on the figure below.

Table 9-3 Natural gas properties modes

AGA8-92DC method	Normal range of parameters	Expanded range of parameters
Pressure absolute	0 ... 120 bar	0 ... 1400 bar
Temperature	-10 ... +65 oC	-130 ... +200 oC
Components	mole %	mole %
Methane	45 ... 100	0 ... 100
Nitrogen	0 ... 50	0 ... 100
Carbon-dioxide	0 ... 30	0 ... 100
Ethane	0 ... 10	0 ... 100
Propane	0 ... 4	0 ... 12
Water	0 ... 0.05	0 ... 1
Hydrogen-sulfide	0 ... 0.02	0 ... 100
Hydrogen	0 ... 10	0 ... 100
Carbon-monoxide	0 ... 3	0 ... 3
Oxygen	0	0 ... 21
Butanes	0 ... 1	0 ... 6
Pentanes	0 ... 0.3	0 ... 4
Hexanes plus	0 ... 0.2	0 ... 1
Helium	0 ... 0.2	0 ... 3
Argon	0	0 ... 1

VNIC SMV method	Normal range of parameters	
Pressure absolute	0 ... 120 bar	
Temperature	-3 ... +67 oC	
Components	mole %	
Methane	65 ... 100	
Nitrogen	0 ... 15	
Carbon-dioxide	0 ... 15	
Ethane	0 ... 15	
Propane	0 ... 3.5	
Hydrogen-sulfide	0 ... 30	
Butanes	0 ... 1.5	
Others	0 ... 1.0	

AGA8 Part 2 – 2017 method	Pipeline quality range of parameters	Intermediate quality range of parameters
Pressure absolute	0 ... 350 bar	0 ... 350 bar
Temperature	-100 ... +177 °C	-100 ... +177 °C
Components	mole %	mole %
Methane	70 – 100	30 – 100
Nitrogen	0 – 20	0 – 55
Carbon-dioxide	0 – 20	0 – 30
Ethane	0 – 10	0 – 25
Propane	0 – 3.5	0 – 14
Butanes	0 – 1.5	0 – 6
Pentanes	0 – 0.5	0 – 0.5
n-Hexane	0 – 0.1	0 – 0.2
n-Heptane	0 – 0.05	0 – 0.1
n-Octane+n-Nonane+n-Decane	0 – 0.05	0 – 0.05
Hydrogen	0 – 10	0 – 40
Oxygen	0 – 0.02	0 – 2
Carbon-monoxide	0 – 3	0 – 13
Water	0 – 0.015	0 – 0.02
Hydrogen-sulfide	0 – 0.02	0 – 27
Helium	0 – 0.5	0 – 0.5
Argon	0 – 0.02	0 – 0.05

AGA8 Part 1 – 2017 method	Range A	Range B	Range C

Pressure absolute upper limit	103 bar	21 bar	210 bar
Temperature lower limit	-4 °C	-4 °C	-4 °C
Components	mole %	mole %	
Methane	100	100	100
Nitrogen	50	50	3.0
Carbon-dioxide	30	80	3.0
Ethane	10	25	4.0
Propane	4	6	2.0
i-Butane	0.4	1.5	0.1
n-Butane	0.6	6.0	0.4
i-Pentane	0.3	2.0	0.1
n-Pentane	0.3	2.0	0.1
Pentanes	0.3	2.0	
n-Hexane	0.12	0.2	0.03
n-Heptane	0.04	0.2	0.01
n-Octane	0.03	0.2	0.003
n-Nonane	0.03	0.2	0.003
n-Decane	0.03	0.2	0.003
Total hexanes+	0.15		
Total heptanes+	0.04		
Hydrogen	5.0	100	1.0
Oxygen	0.2	1.0	0.2
Carbon-monoxide	1.0	10	1.0
Water	0.1	1.4	0.005
Hydrogen-sulfide	0.1	4.0	0.1
Helium	0.4	5.0	0.4
Argon	0.2	3.0	0.2

Table 9-4 Ranges of gas mixture characteristics for compression factor calculation from detailed gas composition

AGA8/92Gr1 and Gr2 method and SGERG 88 method	Normal range of parameters	Expanded range of parameters
Pressure absolute	0 ... 120 bar	0 ... 120 bar
Temperature	-10 ... +65 oC	-23 ... +77 oC
Superior calorific value	30 ... 45 MJ/m ³	20 ... 48 MJ/m ³
Relative density	0.55 ... 0.80	0.55 ... 0.90
Nitrogen	0 ... 20	0 ... 50
Carbon-dioxide	0 ... 20	0 ... 30
Hydrogen	0 ... 10	0 ... 10

GERG91mod method	Normal range of parameters	Expanded range of parameters
Pressure absolute	0 ... 120 bar	120 ... 300 bar
Temperature	-23 ... +57 oC	-13 ... +67 oC
Base density	0.668 ... 0.70 kg/m ³	0.668 ... 1.0 kg/m ³

NX19mod method	Normal range of parameters	Expanded range of parameters
Pressure absolute	0 ... 30 bar	120 ... 300 bar
Temperature	-23 ... +17 oC	-13 ... +17 oC
Base density	0.668 ... 0.70 kg/m ³	0.668 ... 1.0 kg/m ³

AGA8 Part 1 – 2017 Gross Method 1 Method 2	Range 1	Range 2
Pressure absolute	0 ... 103 bar	0 ... 410 bar
Temperature	-4 ... +62 oC	-8 ... +62 oC
Superior calorific value	34.7 ... 38.7 MJ/m ³	24.8 ... 41 MJ/m ³
Relative density	0.554 ... 0.63	0.554 ... 0.89
Nitrogen	0 ... 7	0 ... 20
Carbon-dioxide	0 ... 3	0 ... 25

Table 9-5. Ranges of gas mixture characteristics for compression factor calculation from limited set of gas composition

9.2.2.1.1.1.2 Coke oven gas

Route in the menu tree:

Parameters	Streams	Physical stream	Stream n.
------------	---------	-----------------	-----------

Fluid	HC gas mixture	Coke oven gas
-------	----------------	---------------

The coke oven gas data pages are identical with natural gas data pages except of the gas composition and the water content. The name of the coke oven gas components and their default concentration are listed in the table below.

Components	Abbreviation	Component in AGA8 calculation	mole % (default)
Nitrogen	N2	Nitrogen	2
Carbon-dioxide	CO2	Carbon-dioxide	3
Hydrogen-sulphide	H2S	Hydrogen-sulphide	0
Water	H2O	Water	1
Methane	C1	Methane	23
Ethane	C2H6	Ethane	2
Ethylene	C2H4	Ethane	0
Oxygen	O2	Oxygen	1
Carbon-monoxide	CO	Carbon-monoxide	9
Hydrogen	H2	Hydrogen	58
Ammonia	NH3	Methane	0
Benzene	C6H6	n-Pentane	1

Table 9-6 Coke oven gas composition

The data page for coke oven gas composition is shown on the figure below.

Function of the F keys on the Coke oven gas data page

- ↓ select the next field for editing
- ↑ select the previous field for editing
- ← return to previous menu level
- Change** modify the selected data field

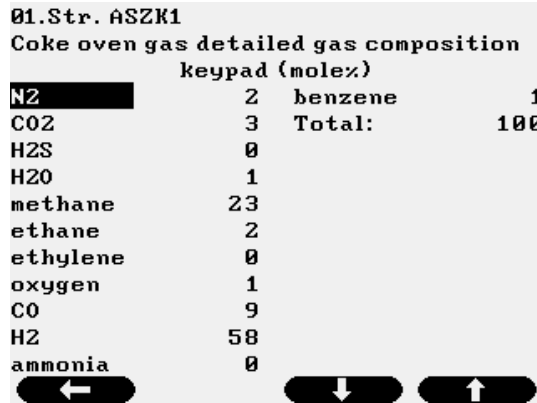
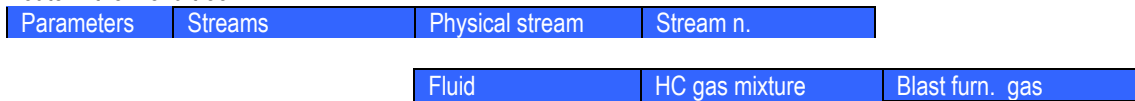

Figure 9-86 Coke oven gas composition data page

- Water content mode (available for Coke oven gas and Blast furnace gas only in metric units);
Selected from the list as follows:
 - from gas composition
Water content is equal to the water content entered on the gas composition data page. No additional calculation is done.
 - keypad
Water content in mg/m³ shall be entered in the next line below. The water content entered will be converted to mole% and will be taken into account in the gas composition after normalization.
 - calculated from P,T
The water content is calculated from the pressure and temperature of the gas, according to the Bukacek equation (IGT Research Bulletin #8).
The calculated water content will be converted to mole% and will be taken into account in the gas composition after normalization.

9.2.2.1.1.1.3 Blast furnace gas

Route in the menu tree:



The blast furnace gas data pages are identical with natural gas data pages except the gas composition and the water content. The name of the blast furnace gas components and their default concentration are listed in the table below.

Components	Abbreviation	Component in AGA8 calculation	mole % (default)
Nitrogen	N2	Nitrogen	57
Carbon-dioxide	CO2	Carbon-dioxide	18
Water	H2O	Water	1
Carbon-monoxide	CO	Carbon-monoxide	21
Hydrogen	H2	Hydrogen	3

Table 9-7 Blast furnace gas composition

The data page for blast furnace gas composition is shown on the figure below.

Function of the F keys on the Blast furnace gas data page

- ↓ select the next field for editing
- ↑ select the previous field for editing
- ← return to previous menu level

Change modify the selected data field

01.Str. NGAS-ORIFICE	
Blast furn.gas detailed gas composition	
	Keypad (mole%)
N2	57
CO2	18
H2O	1
CO	21
H2	3
Total:	100

Figure 9-87 Blast furnace gas composition data page

- Water content mode (available for Coke oven gas and Blast furnace gas only in metric units);
Selected from the list as follows:
 - from gas composition
Water content is equal to the water content entered on the gas composition data page. No additional calculation is done.
 - keypad
Water content in mg/m³ shall be entered in the next line below. The water content entered will be converted to mole% and will be taken into account in the gas composition after normalization.
 - calculated from P,T
The water content is calculated from the pressure and temperature of the gas, according to the Bukacek equation (IGT Research Bulletin #8).
The calculated water content will be converted to mole% and will be taken into account in the gas composition after normalization.

9.2.2.1.1.2 Pure gases

Predefined pure gases are as follows

- Air;
- Nitrogen;
- Oxygen;
- Argon;
- Carbon-dioxide;
- Hydrogen;
- Carbon-monoxide;
- Ethylene;
- Ammonia;
- Propane;
- General gas;

The compression factor, dynamic viscosity and isentropic exponent for these gases are calculated according to HE-64 (calculation procedure of Hungarian Office of Measures). The calculation methods described in HE-64 based on the text books, articles as listed in the bibliography of the HE-64.

The data page for pure gases, except "General gas" is shown on the figure below.

Function of the F keys on the Pure gases data page

- ↓ select the next field for editing
- ↑ select the previous field for editing

Change modify the selected data field

Save save the selected/entered data and returns to the parent menu.

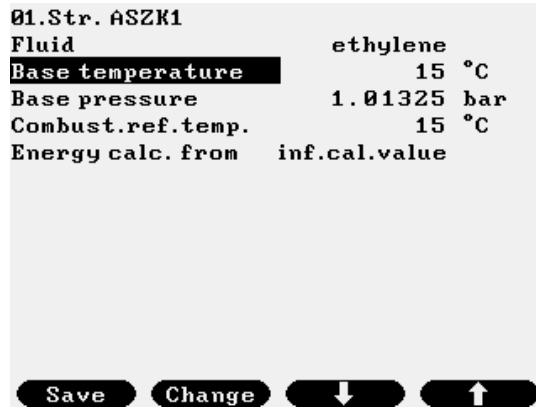

Figure 9-88 Predefined pure gas data page

If the measured gas is not listed in the predefined pure gas list then “General gas” shall be selected. In this case the different properties of the gas shall be entered as keypad values or as measured values as appropriate. In latter case the IO channel the measured properties is assigned to shall be defined in the Stream setup menu.

The data page for “General gas” is shown on the figure below.

Function of the F keys on the General gas data page

↓ select the next field for editing

↑ select the previous field for editing

Change modify the selected data field

Save save the selected/entered data and returns to the parent menu.

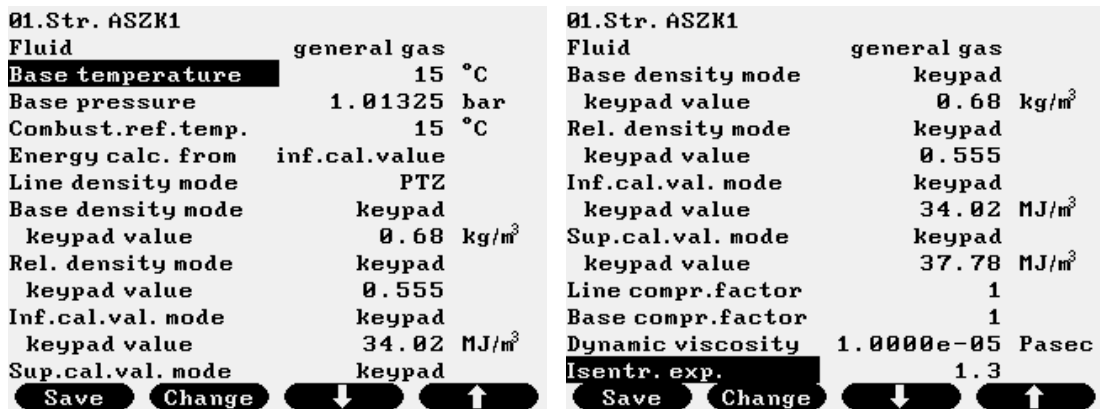
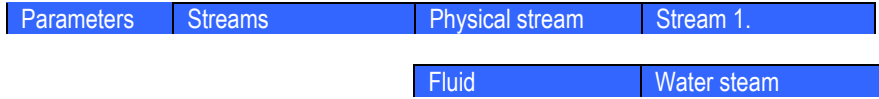

Figure 9-89 General gas data page

9.2.2.1.1.3 Water steam

Route in the menu tree:



The water steam properties are calculated according to Industrial Formulation 1997 for the Thermodynamic Properties of Water and Steam (IAPWS-IF97).

The water steam data page is shown on the figure below.

Function of the F keys on the Water steam data page

↓ select the next field for editing

↑ select the previous field for editing

Change modify the selected data field

Save save the selected/entered data and returns to the parent menu.

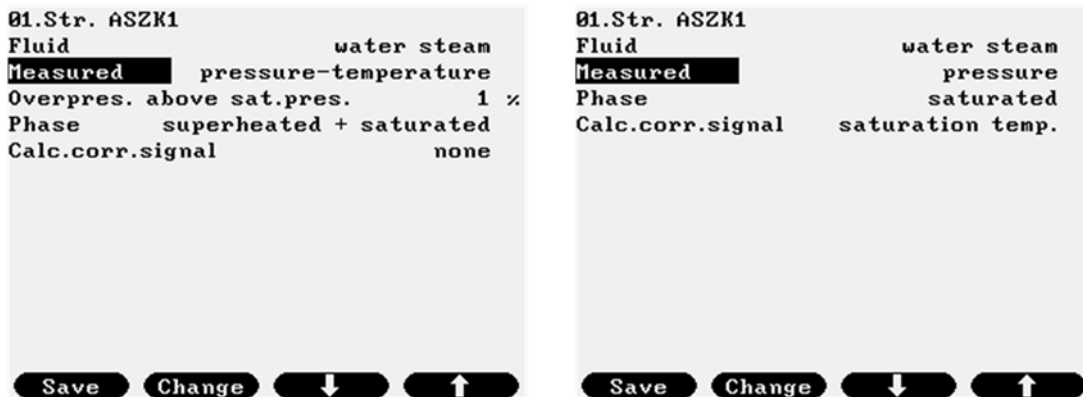

Figure 9-90 Water steam data page for superheated and saturated steam

The data fields on the data page are as follows:

- Fluid;
 - Not editable, fixed to water steam.
- Measured;
 - The measured parameters are selected from the list:
 - pressure-temperature
 - it is assumed that water steam phase is superheated and both temperature and pressure input is required to calculate the properties of the steam.
 - Numeric input
 - overpressure above saturation pressure, in %
 - is required in this case. In fact this parameter takes into consideration the uncertainty in pressure measurement.
 - The flow computer calculates the saturation pressure for the measured temperature. If the measured pressure is above the saturation pressure plus the overpressure parameter then UNIFLOW-200 raises alarm. While the pressure is below this limit UNIFLOW-200 continues the calculation with the measured pressure.
 - pressure
 - it is assumed that water steam phase is saturated. The temperature of the steam is calculated from the saturation line and the properties are calculated from the measured pressure and from the saturation temperature.
 - temperature
 - it is assumed that water steam phase is saturated. The pressure of the steam is calculated from the saturation line and the properties are calculated from the measured temperature and from the saturation pressure.

9.2.2.1.1.4 Water

Route in the menu tree:

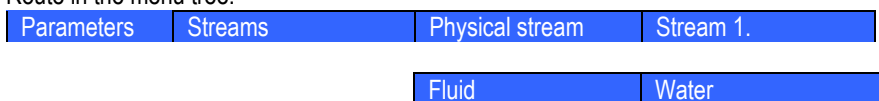

The water properties are calculated according to Industrial Formulation 1997 for the Thermodynamic Properties of Water and Steam (IAPWS-IF97).

The water data page is shown on the figure below.

Function of the F keys on the Water data page

Change modify the selected data field

Save save the selected/entered data and returns to the parent menu.

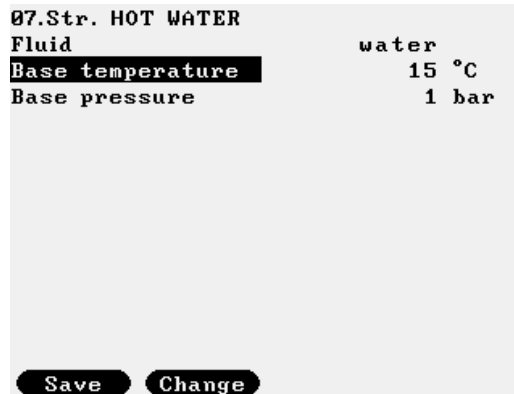

Figure 9-91 Water data page

The data fields on the data page are as follows:

- Base temperature;
 - The base temperature selected from list
 - 15 °C;
 - 20 °C.
- Base pressure;
 - Not editable, fixed to 1 bar

9.2.2.1.1.5 Liquids

9.2.2.1.1.5.1 Crude oil and products

Route in the menu tree:

Parameters	Streams	Physical stream	Stream 1.
------------	---------	-----------------	-----------

Fluid	Liquid	Crude oil & product
-------	--------	---------------------

The crude oil and product data page is shown on the figure below.

Function of the F keys on the Crude oil and products data page

↓ select the next field for editing

↑ select the previous field for editing

⇒ enter into submenu for gas composition editing

Change modify the selected data field

OK Confirm the selection

Save save the selected/entered data and returns to the parent menu.

04.Str. CR.OIL-LIQ.TURBINE		04.Str. CR.OIL-LIQ.TURBINE	
Fluid	crude oil	CPL mode	Chapter 11.2.1M(1984)
Base temperature	15 C	Density	meas.at header
Base pressure	1 barG	Base density mode	calculated
CTL mode	Table 53A,54A(1980)	Aerometer glass corr.	no
CPL mode	Chapter 11.2.1M(1984)	Rounding	no
Density	meas.at header	Density at fl.meter	calculated
Base density mode	calculated	Energy flow calc.	yes
Aerometer glass corr.	no	Cal.value mode	keypad
Rounding	no	keypad value	40.36000 MJ/kg
Density at fl.meter	calculated	CO2 emission factor	73.30000 kg/GJ
Energy flow calc.	yes	Viscosity type	kinematic
Cal.value mode	keypad	Viscosity mode	keypad
keypad value	40.36000 MJ/kg	keypad value	30 mm2/s
Save	Change	Save	Change

Figure 9-92 Crude oil and product data page

The data fields on the data page are as follows:

- Fluid;
 - Select the type of the fluid from the list:
 - crude oil;
 - products;
 - lubricating oil;
 - NGL & LPG
 - UGC STO 5.9 (unstable gas condensate according to Gazprom STO 5.9)
 - SLH STO 5.9 (stable liquid hydrocarbon according to Gazprom STO 5.9)
 - WFLH STO 5.9 (wide fraction of light hydrocarbons according to Gazprom STO 5.9)
- Base temperature;
 - See the available options in Table 9-8.
- Base pressure;
 - See the available options in Table 9-8.
- CTL mode;
 - See the available options in Table 9-8.
- CPL mode;
 - See the available options in Table 9-8.

Liquid	CTL mode	Base temperature (metric)	Base pressure (metric)	CPL mode (metric)	Base temperature (imperial)	Base pressure (imperial)	CPL mode (imperial)
Crude oil	Table 53A, 54A (1980)	15 °C	0 barG	Chapter 11.2.1M (1984)			
Refined products	Table 53B, 54B (1980) Table 53C, 54C (1980)	15 °C	0 barG	Chapter 11.2.1M (1984)			
NGL & LPG	Table 53E, 54E (2007) Table 59E, 60E (2007)	15 °C 20 °C	0 barG	Chapter 11.2.2M (1984)			
Crude oil	Table 23A, 24A (1980)				60 °F	0 PSIG	Chapter 11.2.1 (1984)
Refined products	Table 23B, 24B (1980) Table 23C, 24C (1980)				60 °F	0 PSIG	Chapter 11.2.1 (1984)
NGL & LPG	Table 23E, 24E (2007)				60 °F	0 PSIG	Chapter 11.2.2 (1986)
Crude oil, refined products, lubricating oil	Chapter 11.1 (2004)	15 °C 20 °C	0 barG	Chapter 11.1 (2004)	60 °F	0 PSIG	Chapter 11.1 (2004)
Unstable gas condensate	STO Gazporm 5.9 B.1 (2007)	20 °C	1.0132 barA	STO Gazporm 5.9 B.1 (2007)			
Stable hydrocarbon liquid	STO Gazprom 5.9 B.2 (2007)	15 °C	0 barG	STO Gazprom 5.9 B.2 (2007)			
Wide fraction of light hydrocarbons	STO Gazporm 5.9 B.3 (2007)	15 °C 20 °C	0 barG	STO Gazporm 5.9 B.3 (2007)			

Table 9-8 CTL and CPL modes, base temperature and base pressure options for liquid hydrocarbons

Density mode;

The density mode selected from the list:

- meas. at fl. meter (measured at flow meter)

If density is measured at flow meter then:

- the measured density at flow meter will be converted to base density with the meter pressure and meter temperature;

- not measured;

If density is not measured then keypad value for density at base conditions shall be entered. The Base density mode set to keypad automatically.

- meas. at header (measured at header pipe);

If density is measured at header pipe then:

- the measured header density will be converted to base density with the header pressure and header temperature;
- the base density will be converted to density at meter with the meter pressure and meter temperature;

- Base density mode;

The density mode selected from the list:

- calculated;

The base density is calculated from the measured (at header or at meter) density. In case of line density transmitter failure the keypad value of the line density is used in the base density calculations.

- Calculated/external;

The base density is calculated from the measured (at header or at meter) density. In case of line density transmitter failure the base density is assumed to be constant. The value of the base density is selected from the Product definition table, defined in the Stream setup menu. The product definition table consists of maximum 16 products with the corresponding keypad base densities. The product the base density of which to be used in the calculation is defined via communication interface.

This option is used when Batching is enabled and the Batch type is "Pipeline product interface".

Set to calculated if the density mode is measured at flow meter or at the header pipe.

Set to external if the density mode is not measured.

If set to external, source of the base density (measured, Modbus, keypad) is defined in the stream setup menu.

- Density at flow meter mode;

Not editable.

Set to calculated if the density mode is measured at header pipe or not measured.

Set to measured if the density mode is measured at flow meter.

- Energy calculation mode;

- o no;
- o yes;

If energy calculation is required then new entry fields appear allowing enter the calorific value mode and the keypad calorific value if not measured. Enabling energy calculation enables the CO2 emission calculation as well. The CO2 emission calculation requires the CO2 emission factor to be entered.

If the fluid type is Products then the subtype of the fuel for CO2 emission shall be selected.

If the fluid type is Crude oil then no subtype selection is required.

The default calorific value and CO2 emission factor for the different fuels are shown in the Table 9.4. below.

Both the calorific value and CO2 emission factor can be modified to suit local requirements.

- Fuel subtype (if the fluid = Products only);
 - o heating oil;
 - o fuel oil;
 - o low sulfur heating oil;
 - o heavy heating oil;
 - o gasoline;
 - o diesel oil;
- Calorific value mode;
 - o keypad;
 - keypad calorific value;
 - o measured;

Signal representing the calorific value is measured on input channel. One channel in I/O signal setup section should be configured as “Calorific value” signal type.
- CO2 emission factor;

Keypad value for CO2 emission factor;
- Viscosity type;
 - o kinematic;
 - o dynamic;

Selection of the desired viscosity type
- Viscosity mode;
 - o keypad;

The operator entered keypad value is used in the flow calculation.
 - o Modbus signal;

Signal representing the kinematic viscosity value is measured on Modbus input channel. One Modbus channel in I/O signal setup section should be configured as “Kinematic viscosity” or “Dynamic viscosity” signal type.
 - o measured; (available for kinematic viscosity only)

Signal representing the kinematic viscosity value is measured on input channel. One analog channel in I/O signal setup section should be configured as “Kinematic viscosity” signal type.
- Keypad value;

Keypad value of the viscosity, dynamic or kinematic;

Fuel type	Calorific value, MJ/kg	CO2 emission factor, tCO2/TJ
Crude oil	40.36	73.3
Heating oil	42.0	74.07
Fuel oil	41.0	77.37
Low sulfur heating oil	40.0	77.37
Heavy heating oil	39.5	77.37
Gasoline	44.0	69.3
Diesel oil	42.0	74.07

Table 9-9 Default values of the calorific value and CO2 emission factors

Temperature and pressure correction of the measured density to the base density and the base density to the density at meter is done according to the method selected in CTL mode and CPL mode menu. See Table 9-8.

NOTE

If the fluid type is Product the subtype of the product (gasoline, intermediate, jet fuel, fuel oil) determined automatically based on the density at base conditions. The limits of the base densities for the product subtypes applied as defined in the standards selected in CTL mode selection menu.

NOTE

The product subtype classified on the base density different from the fuel subtype described in the CO2 emission section.

9.2.2.1.1.5.2 Ethanol

Route in the menu tree:

Parameters	Streams	Physical stream	Stream 1.
------------	---------	-----------------	-----------

Fluid	Liquid	Ethanol
-------	--------	---------

The ethanol data page is shown on the figure below.

Function of the F keys on the Ethanol data page

↓ select the next field for editing

↑ select the previous field for editing

⇒ enter into submenu for gas composition editing

Change modify the selected data field

OK Confirm the selection

Save save the selected/entered data and returns to the parent menu.

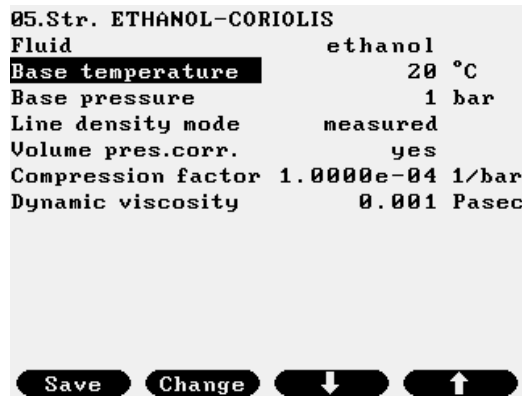

Figure 9-93 Ethanol data page

The data fields on the data page are as follows:

- Fluid;
 - Not editable, fixed to Ethanol
- Base temperature;
 - The base temperature selected from list
 - 20 °C;
 - 15 °C;
 - 0 °C;
- Base pressure;
 - Not editable, fixed to 1 bar.
- Density mode;
 - The density mode selected from the list:
 - measured;
 - Signal representing the line density value is measured on input channel. One channel in I/O signal setup section should be configured as "Line density" signal type. In this case no concentration entry field appears.
 - calculated;
 - If density mode is calculated then the concentration of the ethanol (the alcohol strength) shall be provided. The line density will be calculated based on the concentration, temperature and pressure.
- Concentration;
 - measured;
 - Signal representing the concentration value is measured on input channel. One channel in I/O signal setup section should be configured as "Special" signal type.
 - keypad;
 - keypad concentration value;
- Unit of measurement for concentration;
 - If the concentration is fixed then the unit of measurement is selectable form the list:
 - % (V/V) ; (volume %)

- % (m/m) ; (mass %)
- If the concentration is measured then the unit of measurement is fixed to volume %.
- Volume press. corr. (Pressure volume correction mode);
If pressure volume correction is enabled then compression factor shall be entered.
 - no;
 - yes;
- Compression factor keypad value;
- Dynamic viscosity keypad value;

9.2.2.1.1.5.3 General liquid

Route in the menu tree:

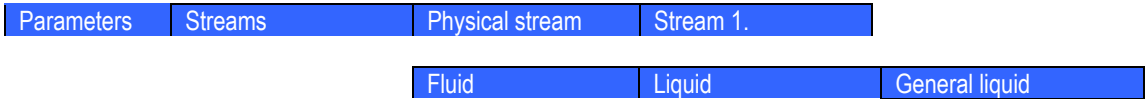

The general liquid data page is shown on the figure below.

Function of the F keys on the General liquid data page

- ↓ select the next field for editing
- ↑ select the previous field for editing
- ⇒ enter into submenu for gas composition editing
- Change** modify the selected data field
- OK** Confirm the selection
- Save** save the selected/entered data and returns to the parent menu.

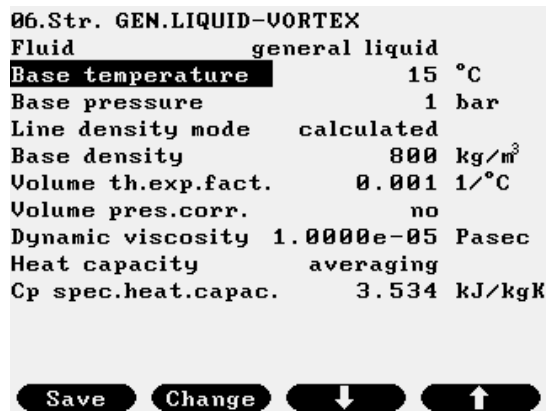

Figure 9-94 General liquid data page

The data fields on the data page are as follows:

- Fluid;
Not editable, fixed to General liquid
- Base temperature;
The base temperature selected from list
 - 20 °C;
 - 15 °C;
 - 0 °C;
- Base pressure;
Not editable, fixed to 1 bar.
- Density mode;
The density mode selected from the list:
 - measured;
Signal representing the line density value is measured on input channel. One channel in I/O signal setup section should be configured as "Line density" signal type.
 - calculated;
If density mode is calculated then the density at base conditions shall be provided. The line density will be calculated based on the base density, temperature and pressure.
- Base density keypad value;

- Coefficient of thermal expansion;
Keypad value shall be entered.
- Pressure volume correction mode;
If pressure volume correction is enabled then compression factor shall be entered.
 - o no;
 - o yes;
- Compression factor;
Keypad value shall be entered.
- Dynamic viscosity;
Keypad value shall be entered.
- Heat capacity;
The method of the determination of heat capacity is selected from the list:
 - o average;
Average heat capacity is entered as keypad value.
 - o calculated $a \cdot T(^{\circ}\text{C}) + b$;
Heat capacity is calculated as the linear function of the temperature.
- Cp specific Heat capacity (appears if heat capacity is average);
- a (appears if heat capacity is calculated $a \cdot T(^{\circ}\text{C}) + b$);
- b (appears if heat capacity is calculated $a \cdot T(^{\circ}\text{C}) + b$);

9.2.2.1.1.5.4 Liquid mixture

Route in the menu tree:

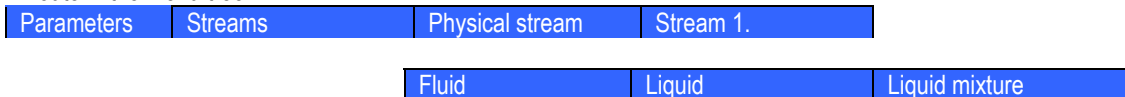

The liquid mixture data page is shown on the figure below.

Function of the F keys on the Liquid mixture data page

- ↓ select the next field for editing
- ↑ select the previous field for editing
- ⇒ enter into submenu for gas composition editing

Change modify the selected data field

OK Confirm the selection

Save save the selected/entered data and returns to the parent menu.

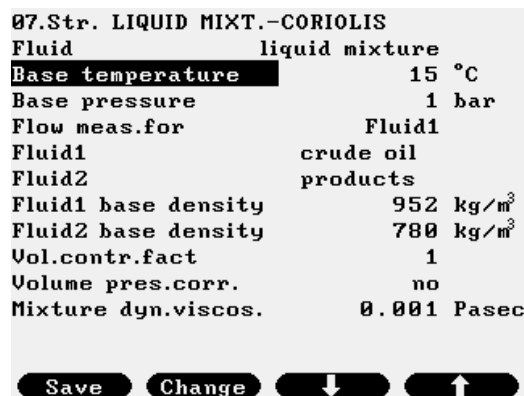

Figure 9-95 Liquid mixture data page

The liquid mixture fluid option is intended for application where flow of mixture of two different liquids is measured. The density of the mixture is measured as well. Beside the measurement of flow of the mixture the two separate flows for the components the mixture consists of shall be determined. Example of such application is measurement of the mixture of crude oil and gasoline pumped into pipeline.

The data fields on the data page are as follows:

- Fluid;
Not editable, fixed to Liquid mixture

- Base temperature;
The base temperature selected from list
 - 20 °C;
 - 15 °C;
 - 0 °C;
- Base pressure;
Not editable, fixed to 1 bar.
- Flow measured for;
Selected from the list:
 - fluid 1;
 - fluid 2;
 - mixture;

One metering stream of UNIFLOW-200 measures (calculates) and totalizes flow for one single fluid.
To have flows and totals for the two liquid components and for the mixture three streams shall be defined with identical parameters except this parameter. In each stream its own fluid to be selected in this data entry.
- Fluid 1 type;
Selected from the list:
 - crude oil;
 - product;
 - NGL & LPG
 - general liquid;
- Fluid 2 type;
Selected from the list:
 - crude oil;
 - product;
 - NGL & LPG
 - general liquid;
- Fluid 1 base density;
Selected from the list:
 - keypad;
 - keypad base density value;
 - Modb. sign.;

Modbus I/O signal must be defined for the base density of fluid 1. At the stream setup page, the Modbus signal channel representing the base density shall be assigned to the base density.
- Fluid 1 thermal expansion factor;
Keypad value shall be entered.
It is appears only if Fluid 1 type is General liquid.
In case of crude oil and products thermal expansion factor is calculated according to 53A/54A and 53B/54B respectively.
In case of LPG & LNG thermal expansion factor is calculated according to Table 53E/54E (metric units) or Table 23E/24E (imperial units).
- Fluid 2 base density;
Selected from the list:
 - keypad;
 - keypad base density value;
 - Modb. sign.;

Modbus I/O signal must be defined for the base density of fluid 2. At the stream setup page, the Modbus signal channel representing the base density shall be assigned to the base density.

Fluid 1 base density and Fluid 2 base density must not be equal.
- Fluid 2 thermal expansion factor;
Keypad value shall be entered.
It is appearing only if Fluid 2 type is General liquid.
In case of crude oil and products thermal expansion factor is calculated according to 53A/54A and 53B/54B respectively.
In case of LPG & LNG thermal expansion factor is calculated according to Table 53E/54E (metric units) or Table 23E/24E (imperial units).
- Volume contraction factor;
Keypad value shall be entered.
It takes into account the volume change in case of mixing two different fluids.
Default value is 1.0 (no change in the volume), allowable range from 0.95 to 1.05
- Pressure volume correction mode;
It pressure volume correction is enabled then compression factor shall be entered.
 - no;

- o yes;
- Fluid 1 compression factor;
Keypad value shall be entered.
It is appears only if Fluid 1 type is General liquid. In case of crude oil and products compression factor is calculated according to MPMS Chapter 11.1.
In case of LPG & LNG compression factor is calculated according to Chapter 12.2.2M (metric units) or Chapter 12.2.2 (imperial units).
- Fluid 2 compression factor;
Keypad value shall be entered.
It is appears only if Fluid 2 type is General liquid. In case of crude oil and products compression factor is calculated according to MPMS Chapter 11.1.
In case of LPG & LNG compression factor is calculated according to Chapter 11.2.2M (metric units) or Chapter 12.2. (imperial units).
- Mixture dynamic viscosity;
Keypad value shall be entered.

9.2.2.1.1.5.5 *Electric power*

Route in the menu tree:

Parameters	Streams	Physical stream	Stream 1.
------------	---------	-----------------	-----------

Fluid	Liquid	Electric power
-------	--------	----------------

The “Electric power” fluid selection is intended for electrical power measurement. In this case no flow calculation is required. Input signal from electric power meter is received and only totalization is performed, the electric power is totalized. The unit for the input channel representing the flow rate (in case of the electrical power measurement) shall be selected as MW or MVA in this case.

The flow meter shall be selected as “Electric power meter”.

No data page will appear in this case. Message “Fluid electric power selected” and “Electric power meter selected” will appear on the screen for fluid and flow meter selection respectively.

9.2.2.1.2 *Flow meter selection*

After the fluid is selected and the parameters are setup the flow meter shall be defined.

Depending on the flow meter selected the flow meter specific data page appears.

The figures in this chapter explain the parameters of the different flow meters to be defined and the options available for selection.

Function of the F keys on the Flow meter selection data pages

- ⇩ select the next field for editing
- ⇩ select the previous field for editing
- ⇒ enter into submenu for error curve editing

Change modify the selected data field

OK Confirm the selection

Save save the selected/entered data and returns to the parent menu.

9.2.2.1.2.1 **Differential pressure devices**

9.2.2.1.2.1.1 *Orifice plate*

Route in the menu tree:

Parameters	Streams	Physical stream	Stream 1.
------------	---------	-----------------	-----------

Flow meter	Diff. press. device	Orifice meter
------------	---------------------	---------------

01.Str. NGAS-ORIFICE	
Flow meter	Orifice plate
dP tappings	Flange
Flow standard	ISO5167:2003
Pipe diam.at 20°C	200 mm
Bore diam.at 20°C	100 mm
Pipe th. expansion	1.0000e-05 1/°C
Orifice th.expans.	2.0000e-05 1/°C
Temperature tappings	downstream
Measured temp. corr.	yes
Pipe diam.press.corr.	no
P transmit.level corr.	0 mm

Save Change ↓ ↑

Figure 9-96 Orifice plate meter data page

The data fields on the data page are as follows:

- dP tappings (Differential pressure tappings);
Selected from the list:
 - flange;
 - corner;
 - D and D/2;
- Flow standard;
Selected from the list:
 - ISO 5167:1991;
 - ISO 5167:1998;
 - ISO 5167:2003;
 - GOST 8.563:1997;
 - GOST 8.586:2005;
 - AGA 3:1990
 - AGA 3:2012
- Pipe diameter at 20 oC;
Keypad value shall be entered.
- Orifice bore diameter at 20 oC;
Keypad value shall be entered.

In case of flow standards ISO 5167 (any edition) and AGA 3 (any edition) the thermal expansion coefficients are entered as follows

- Pipe thermal expansion coefficient;
Keypad value shall be entered.
- Orifice thermal expansion coefficient;
Keypad value shall be entered.

In case of flow standards GOST 8.563-1997 or GOST 8.586-2005 the thermal expansion coefficients are entered as follows

- Pipe th. exp. mode (Pipe thermal expansion factor mode)
 - calculated;
Selection list is opened and the material of the pipe can be selected from the list. See Table 9-10. Thermal expansion coefficient is calculated according to GOST 8.563-1997 or GOST 8.586-2005 respectively.
 - keypad;
The operator entered keypad value is used in the flow calculation
- Orifice th. exp. mode (Orifice thermal expansion factor mode)
 - calculated;
Selection list is opened and the material of the pipe can be selected from the list. See Table 9-10. Thermal expansion coefficient is calculated according to GOST 8.563-1997 or GOST 8.586-2005 respectively.
 - keypad;
The operator entered keypad value is used in the flow calculation
- Temperature tappings; (Available only if flow standard is ISO 5167 (any edition))Selected from the list:
 - upstream;
 - downstream;

- Measured temperature correction;
Appears only if downstream temperature tapping is selected.
If enabled the in case of ISO5167 : 1991 flow standard isentropic correction, in case of ISO5167 : 1998 and ISO5167 : 2003 flow standard isenthalpic correction is applied to the temperature measured downstream to calculate the upstream temperature.
No measured temperature correction is applied in case of any other flow standard.
Selected from the list:
 - no;
 - yes;
- Pipe diameter pressure correction;
If enabled then the pipe diameter is corrected for the internal pressure before the thermal expansion calculation is applied.
Selected from the list:
 - no;
 - yes;
- Pipe wall thickness;
It is appears only if Pipe diameter pressure correction is enabled.
Keypad value shall be entered.
- Pipe Young modulus;
It is appears only if Pipe diameter pressure correction is enabled.
Keypad value shall be entered.
- Pipe wall roughness;
It is appears only if Flow standard GOST 8.563 or GOST 8.586 is selected.
Keypad value shall be entered.
- Orifice rounding radius;
It is appears only if Flow standard GOST 8.563 or GOST 8.586 is selected.
Keypad value shall be entered.
- Interval between checks;
It is appears only if Flow standard GOST 8.563 or GOST 8.586 is selected.
Keypad value shall be entered.
- Pressure transmitter level correction;
It compensates the hydrostatic pressure of the fluid in the pressure transmitter impulse line. The sign shall be: plus (+) if the pressure transmitter located above the pressure tapping points minus (-)if the pressure transmitter located below the pressure tapping points
In case of gas flow measurement the level correction can be neglected.
Keypad value shall be entered.

No	GOST 8.563-1997	GOST 8.586-2005
1	8	35L
2	10	45L
3	15	20HML
4	15M	12H18N9TL
5	16M	15K_20K
6	20	22K
7	20M	16GS 09G2S
8	25	09G2S
9	30	10
10	35	15
11	H6SzM	20
12	H7SzM	30_35
13	12MH	40_45
14	12H1MF	10G2
15	12H17	38HA
16	12H18N9T	40H

17	12H18N10T	15HM
18	14H17N2	30HM_30HMA
19	15HMA	12H1MF
20	15H1M1F	25H1MF
21	15H5M	25H2M1F
22	15H12ENMF	15H5M
23	17H18N9	18H2N4MA
24	20H23N13	38HN3MFA
25	36H18N25Sz2	08H13
26		12H13
27		20H13
28		30H13
29		10H14G14N4T
30		08H18N10
31		12H18N9T
32		12H18N10_12T
33		08H18N10T
34		08H22N6T
35		37H12N8G8MFB
36		31H19N9MVBT
37		06HN28MDT
38		20L
39		25L

Table 9-10 Type of steels in GOST standards

9.2.2.1.2.1.2 Nozzle

Route in the menu tree:

Parameters	Streams	Physical stream	Stream 1.
------------	---------	-----------------	-----------

Flow meter	Diff. press. device	Nozzle
------------	---------------------	--------

Ø1.Str. STR1	
Flow meter	Nozzle
Nozzle type	ISA-1932
Pipe diam.at 20°C	200 mm
Bore diam.at 20°C	100 mm
Pipe th. expansion	1.1000e-05 1/°C
Orifice th.expans.	1.6000e-05 1/°C
Temperature tappings	upstream
Pipe diam.press.corr.	no
P transmit.level corr.	0 mm
Save Change ↓ ↑	

Figure 9-97 Nozzle data page

The data fields on the data page are as follows:

- Nozzle type;
Selected from the list:
 - ISA-1932;
 - Long radius;
 - Venturi nozzle;
 The flow standard applied for the nozzle calculation is ISO 5167:2003.

In case of flow standards ISO 5167 (any edition) and AGA 3 (any edition) the thermal expansion coefficients are entered as follows

- Pipe diameter at 20 °C;
Keypad value shall be entered.
- Orifice bore diameter at 20 °C;
Keypad value shall be entered.
- Pipe thermal expansion coefficient;
Keypad value shall be entered.
- Orifice plate thermal expansion coefficient;
Keypad value shall be entered.

In case of flow standards GOST 8.563-1997 or GOST 8.586-2005 the thermal expansion coefficients are entered as follows

- Pipe th. exp. mode (Pipe thermal expansion factor mode)
 - calculated;
Selection list is opened and the material of the pipe can be selected from the list. See Table 9-10. Thermal expansion coefficient is calculated according to GOST 8.563-1997 or GOST 8.586-2005 respectively.
 - keypad;
The operator entered keypad value is used in the flow calculation
- Orifice th. exp. mode (Orifice thermal expansion factor mode)
 - calculated;
Selection list is opened and the material of the pipe can be selected from the list. See Table 9-10. Thermal expansion coefficient is calculated according to GOST 8.563-1997 or GOST 8.586-2005 respectively.
 - keypad;
The operator entered keypad value is used in the flow calculation

Temperature tapping;
Selected from the list:

- upstream;
- downstream;
- Measured temperature correction;
Appears only if downstream temperature tapping is selected.

If enabled the in case of ISO5167 : 1991 flow standard isentropic correction, in case of ISO5167 : 1998 and ISO5167 : 2003 flow standard isenthalpic correction is applied to the temperature measured downstream to calculate the upstream temperature.

No measured temperature correction is applied in case of any other flow standard.

Selected from the list:

- no;
- yes;
- Pipe diameter pressure correction;
If enabled the then the pipe diameter is corrected for the internal pressure before the thermal expansion calculation is applied.
Selected from the list:
 - no;
 - yes;
- Pipe wall thickness;
It is appears only if Pipe diameter pressure correction is enabled.
Keypad value shall be entered.
- Pipe Young modulus;
It is appears only if Pipe diameter pressure correction is enabled.
Keypad value shall be entered.
- Pressure transmitter level correction;
It compensates the hydrostatic pressure of the fluid in the pressure transmitter impulse line. The sign shall be: plus (+) if the pressure transmitter located above the pressure tapping points

minus (-) if the pressure transmitter located below the pressure tapping points
 In case of gas flow measurement the level correction can be neglected.
 Keypad value shall be entered.

9.2.2.1.2.1.3 Venturi tube

Route in the menu tree:

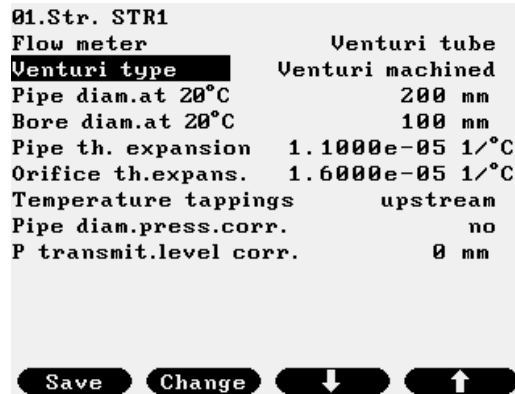
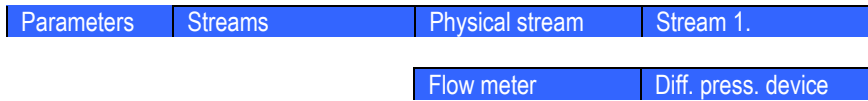

Figure 9-98 Venturi tube data page

The data fields on the data page are as follows:

- Venturi type;
 Selected from the list:
 - Venturi machined;
 - Venturi as cast;
 - Venturi rough-welded;
 The flow standard applied for the Venturi tube calculation is ISO 5167:2003.
- Pipe diameter at 20 oC;
 Keypad value shall be entered.
- Orifice bore diameter at 20 oC;
 Keypad value shall be entered.

In case of flow standards ISO 5167 (any edition) and AGA 3 (any edition) the thermal expansion coefficients are entered as follows

- Pipe thermal expansion coefficient;
 Keypad value shall be entered.
- Orifice plate thermal expansion coefficient;
 Keypad value shall be entered.

In case of flow standards GOST 8.563-1997 or GOST 8.586-2005 the thermal expansion coefficients are entered as follows

- Pipe th. exp. mode (Pipe thermal expansion factor mode)
 - calculated;
 Selection list is opened and the material of the pipe can be selected from the list. See Table 9-10. Thermal expansion coefficient is calculated according to GOST 8.563-1997 or GOST 8.586-2005 respectively.
 - keypad;
 The operator entered keypad value is used in the flow calculation
- Orifice th. exp. mode (Orifice thermal expansion factor mode)
 - calculated;
 Selection list is opened and the material of the pipe can be selected from the list. See Table 9-10. Thermal expansion coefficient is calculated according to GOST 8.563-1997 or GOST 8.586-2005 respectively.
 - keypad;
 The operator entered keypad value is used in the flow calculation

- Temperature tapping;
Selected from the list:
 - upstream;
 - downstream;
- Measured temperature correction;
Appears only if downstream temperature tapping is selected.
If enabled the in case of ISO5167:1991 flow standard isentropic correction, in case of ISO5167:1998 and ISO5167:2003 flow standard isenthalpic correction is applied to the temperature measured downstream to calculate the upstream temperature.
No measured temperature correction is applied in case of any other flow standard.
Selected from the list:
 - no;
 - yes;
- Pipe diameter pressure correction;
If enabled the then the pipe diameter is corrected for the internal pressure before the thermal expansion calculation is applied.
Selected from the list:
 - no;
 - yes;
- Pipe wall thickness;
It is appears only if Pipe diameter pressure correction is enabled.
Keypad value shall be entered.
- Pipe Young modulus;
It is appears only if Pipe diameter pressure correction is enabled.
Keypad value shall be entered.
- Pressure transmitter level correction;
It compensates the hydrostatic pressure of the fluid in the pressure transmitter impulse line. The sign shall be:
plus (+) if the pressure transmitter located above the pressure tapping points
minus (-) if the pressure transmitter located below the pressure tapping points
In case of gas flow measurement the level correction can be neglected.
Keypad value shall be entered.

9.2.2.1.2.1.4 Segmental orifice plate

Route in the menu tree:

Parameters	Streams	Physical stream	Stream 1.
------------	---------	-----------------	-----------

Flow meter	Diff. press. device	Segmental orifice plate
------------	---------------------	-------------------------

01.Str. STR1	
Flow meter	Segm. orif. plate
Pipe diam.at 20°C	200 mm
Error curve	no
Average C	1
P transmit.level corr.	0 mm

Save Change ↓ ↑

Figure 9-99 Segmental orifice plate data page

The data fields on the data page are as follows:

- Pipe diameter at 20 °C;
Keypad value shall be entered.
- Calibration curve;

Selected from the list:

- o no;
- o yes;

If calibration curve is enabled then maximum 10 differential pressures and the corresponding flow coefficient (C) can be entered here from the calibration certificate of the meter.

- dPn; (n = 1 to 10)
- Cn; (n = 1 to 10)

- Average C;
Appears only if calibration curve is disabled
Keypad value of the average flow coefficient shall be entered.
- Pressure transmitter level correction;
It compensates the hydrostatic pressure of the fluid in the pressure transmitter impulse line. The sign shall be: plus (+) if the pressure transmitter located above the pressure tapping points minus (-) if the pressure transmitter located below the pressure tapping points
In case of gas flow measurement the level correction can be neglected.
Keypad value shall be entered.

9.2.2.1.2.1.5 V-Cone meter

Route in the menu tree:

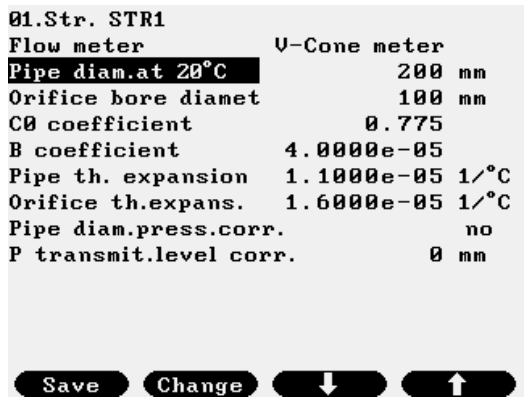
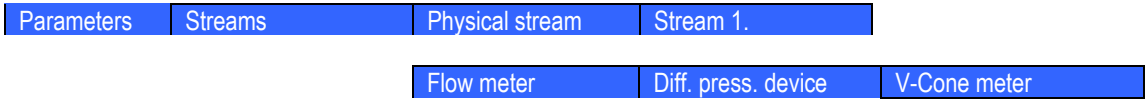

Figure 9-100 V-Cone meter data page

The data fields on the data page are as follows:

- Pipe diameter at 20 oC;
Keypad value shall be entered.
- Equivalent orifice bore diameter at 20 oC;
Keypad value shall be entered.
- C0 coefficient;
Keypad value shall be entered from the certificate of the meter.
- B coefficient;
Keypad value shall be entered from the certificate of the meter.
- Pipe thermal expansion coefficient;
Keypad value shall be entered.
- Orifice plate thermal expansion coefficient;
Keypad value shall be entered.
- Pipe diameter pressure correction;
If enabled the then the pipe diameter is corrected for the internal pressure before the thermal expansion calculation is applied.
Selected from the list:
 - o no;
 - o yes;
- Pipe wall thickness;
It is appears only if Pipe diameter pressure correction is enabled.

- Keypad value shall be entered.
- Pipe Young modulus;
It is appears only if Pipe diameter pressure correction is enabled.
Keypad value shall be entered.
- Pressure transmitter level correction;
It compensates the hydrostatic pressure of the fluid in the pressure transmitter impulse line. The sign shall be:
plus (+) if the pressure transmitter located above the pressure tapping points
minus (-) if the pressure transmitter located below the pressure tapping points
In case of gas flow measurement the level correction can be neglected.
Keypad value shall be entered.

9.2.2.1.2.1.6 Compact/Conditioning orifice plate

Route in the menu tree:

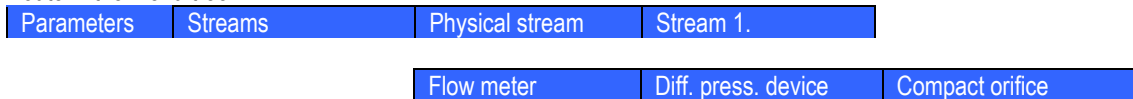

Ø1.Str. STR1	
Flow meter	Compact orifice
dP tapplings	Flange
Flow standard	ISO5167:2003
Pipe diam.at 20°C	200 mm
Bore diam.at 20°C	100 mm
Pipe th. expansion	1.1000e-05 1/°C
Orifice th.expans.	1.6000e-05 1/°C
Calibration factor	0.987
Temperature tapplings	upstream
Pipe diam.press.corr.	no
P transmit.level corr.	0 mm

Save Change ↓ ↑

Figure 9-101 Compact/conditioning orifice plate data page

The data fields on the data page are as follows:

- dP tapplings (Differential pressure tapplings);
Selected from the list:
 - flange;
 - corner;
 - D and D/2;
- Flow standard;
Selected from the list:
 - ISO5167:1991;
 - ISO5167:1998;
 - ISO5167:2003;
- Pipe diameter at 20 °C;
Keypad value shall be entered.
- Orifice bore diameter at 20 °C;
Keypad value shall be entered.
- Pipe thermal expansion coefficient;
Keypad value shall be entered.
- Orifice plate thermal expansion coefficient;
Keypad value shall be entered.
- Calibration factor;
Keypad value shall be entered from the calibration certificate of the meter.
- Temperature tapping;
Selected from the list:
 - upstream;
 - downstream;
- Measured temperature correction;
Appears only if downstream temperature tapping is selected.

If enabled the in case of ISO5167 : 1991 flow standard isentropic correction, in case of ISO5167 : 1998 and ISO5167 : 2003 flow standard isenthalpic correction is applied to the temperature measured downstream to calculate the upstream temperature.

No measured temperature correction is applied in case of any other flow standard.

Selected from the list:

- o no;
- o yes;
- Pipe diameter pressure correction;
If enabled the then the pipe diameter is corrected for the internal pressure before the thermal expansion calculation is applied.
Selected from the list:
 - o no;
 - o yes;
- Pipe wall thickness;
It is appears only if Pipe diameter pressure correction is enabled.
Keypad value shall be entered.
- Pipe Young modulus;
It is appears only if Pipe diameter pressure correction is enabled.
Keypad value shall be entered.
- Pressure transmitter level correction;
It compensates the hydrostatic pressure of the fluid in the pressure transmitter impulse line. The sign shall be: plus (+) if the pressure transmitter located above the pressure tapping points minus (-)if the pressure transmitter located below the pressure tapping points
In case of gas flow measurement the level correction can be neglected.
Keypad value shall be entered.

9.2.2.1.2.2 Annubar

Route in the menu tree:

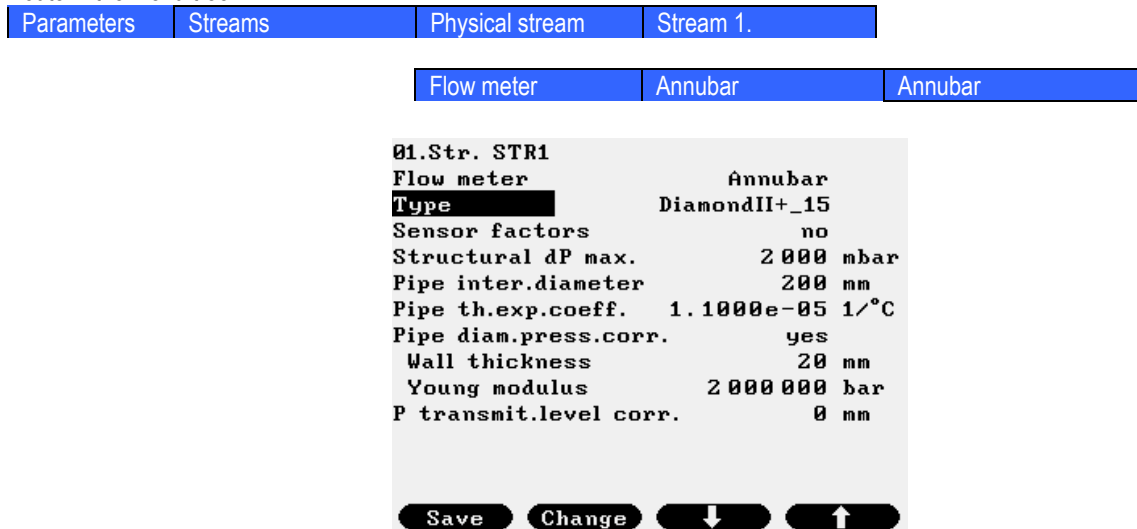

Figure 9-102 Annubar data page

The data fields on the data page are as follows:

- Type
The type of the Annubar meter selected from the list:
 - o Diamond II+ 10;
 - o Diamond II+ 15;
 - o Diamond II+ 25;
 - o Diamond II+ 35;
 - o Diamond II+ 45;
 - o 485 D1;
 - o 485 D2;
 - o 485 D3;
 - o 585 Model 11
 - o 585 Model 22
 - o 585 Model 44

- o Other;
- Sensor factors;
Selected from the list:
 - o no;
 - o yes;
 If sensor factors are enabled then entry fields appear as follows.
 Sensor factor mode (available options)
 - Sensor K-factor (in this case entry fields appear as follows):
 - Sensor K-factor;
 - Min. Reynolds number
 - C1, C2 Constants (in this case entry fields appear as follows):
 - sensor width;
 - sensor C1 constant;
 - sensor C2 constant;
 - thermal expansion coefficient;
 - minimum Reynolds number;

Sensor width and thermal expansion coefficient are editable for all type of Annubar.

C1 and C2 constant and minimum Reynolds number are editable only if "Other" Annubar type is selected. For standard Annubars the manufacturer's constants are applied.

Also, the Sensor K-factor mode options are available only if "Other" Annubar type is selected.

- Structural dP max;
Keypad value shall be entered.
- Pipe diameter at 20 oC;
Keypad value shall be entered.
- Pipe thermal expansion coefficient;
Keypad value shall be entered.
- Pipe diameter pressure correction;
If enabled the then the pipe diameter is corrected for the internal pressure before the thermal expansion calculation is applied.
Selected from the list:
 - o no;
 - o yes;
- Pipe wall thickness;
It is appears only if Pipe diameter pressure correction is enabled.
Keypad value shall be entered.
- Pipe Young modulus;
It is appears only if Pipe diameter pressure correction is enabled.
Keypad value shall be entered.
- Pressure transmitter level correction;
It compensates the hydrostatic pressure of the fluid in the pressure transmitter impulse line. The sign shall be:
plus (+) if the pressure transmitter located above the pressure tapping points
minus (-)if the pressure transmitter located below the pressure tapping points
In case of gas flow measurement the level correction can be neglected.
Keypad value shall be entered.

9.2.2.1.2.3 Verabar

Route in the menu tree:

Parameters	Streams	Physical stream	Stream 1.
------------	---------	-----------------	-----------

Flow meter	Annubar	Verabar
------------	---------	---------

02.Str. ASZK2	
Flow meter	Pitot (Verabar)
Type	Verabar-5
Sensor factors	no
Pipe inter.diameter	200 mm
Pipe th.exp.coeff.	1.1000e-05 1/°C
Pipe diam.press.corr.	yes
Wall thickness	20 mm
Young modulus	2 000 000 bar
P transmit.level corr.	0 mm

Menu ↓ ↑

Figure 9-103 Verabar data page

The data fields on the data page are as follows:

- Type
The type of the Annubar meter selected from the list:
 - Verabar-5;
 - Verabar-10;
 - Verabar-15;
 - Verabar-20;
 - Other;
- Sensor factors;
Selected from the list:
 - no;
 - yes;
 If sensor factors are enabled then entry fields appear as follows.
 - sensor width;
 - sensor C^∞ constant;
 - sensor C_b constant;
 - thermal expansion coefficient;
 Thermal expansion coefficient are editable for all type of Verabar.
 C^∞ and C_b constant editable only if "Other" Verabar type is selected. For standard Verabars the manufacturer's constants are applied.
- Pipe diameter at 20 oC;
Keypad value shall be entered.
- Pipe thermal expansion coefficient;
Keypad value shall be entered.
- Pipe diameter pressure correction;
If enabled the then the pipe diameter is corrected for the internal pressure before the thermal expansion calculation is applied.
Selected from the list:
 - no;
 - yes;
- Pipe wall thickness;
It appears only if Pipe diameter pressure correction is enabled.
Keypad value shall be entered.
- Pipe Young modulus;
It appears only if Pipe diameter pressure correction is enabled.
Keypad value shall be entered.
- Pressure transmitter level correction;
It compensates the hydrostatic pressure of the fluid in the pressure transmitter impulse line. The sign shall be:
 - plus (+) if the pressure transmitter located above the pressure tapping points
 - minus (-) if the pressure transmitter located below the pressure tapping points
 In case of gas flow measurement the level correction can be neglected.
 Keypad value shall be entered.

9.2.2.1.2.4 Accelabar

Route in the menu tree:

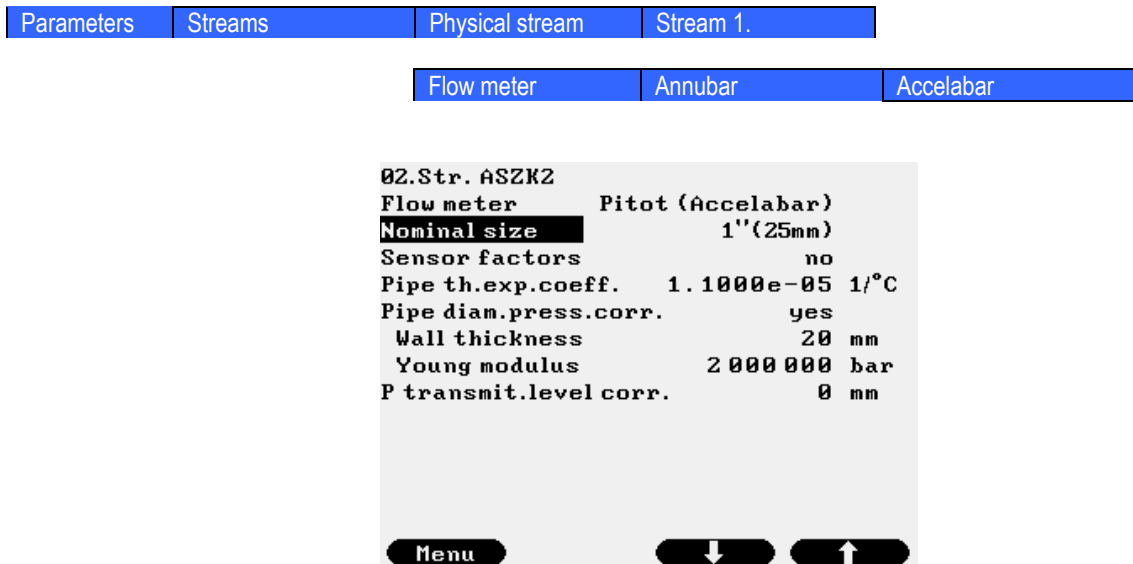

Figure 9-104 Accebar data page

The data fields on the data page are as follows:

- Type
 - The type of the Annubar meter selected from the list:
 - 1" (25 mm)
 - 2" (50 mm)
 - 3" (75 mm)
 - 4" (100 mm)
 - 6" (150 mm)
 - 8" (200 mm)
 - 10" (250 mm)
 - 12" (300 mm)
- Sensor factors;
 - Selected from the list:
 - no;
 - yes;

If sensor factors are enabled then entry fields appear as follows.

 - sensor width;
 - throat diameter;
 - flow coefficient;
 - thermal expansion coefficient;

Only thermal expansion coefficient is editable for all type of Accebar.
For all other factors the manufacturer's constants are applied.
- Pipe thermal expansion coefficient;
 - Keypad value shall be entered.
- Pipe diameter pressure correction;
 - If enabled the then the pipe diameter is corrected for the internal pressure before the thermal expansion calculation is applied.
 - Selected from the list:
 - no;
 - yes;
- Pipe wall thickness;
 - It appears only if Pipe diameter pressure correction is enabled.
 - Keypad value shall be entered.
- Pipe Young modulus;
 - It appears only if Pipe diameter pressure correction is enabled.
 - Keypad value shall be entered.
- Pressure transmitter level correction;
 - It compensates the hydrostatic pressure of the fluid in the pressure transmitter impulse line. The sign shall be:
 - plus (+) if the pressure transmitter located above the pressure tapping points
 - minus (-) if the pressure transmitter located below the pressure tapping points

In case of gas flow measurement the level correction can be neglected.

 - Keypad value shall be entered.

9.2.2.1.2.5 Gas turbine meter, Liquid turbine meter, Vortex meter, Mass flow meter, Ultrasonic meter, Rotameter, Electromagnetic meter, CVOL flow meter, Stream

Route in the menu tree:

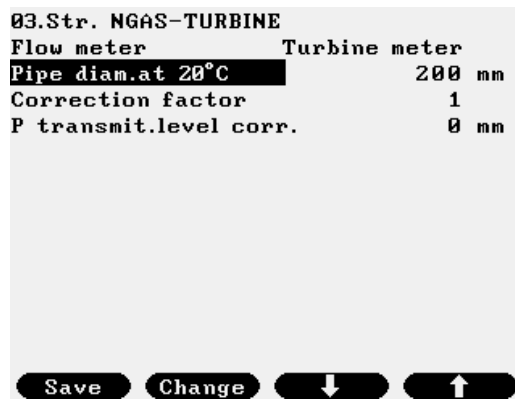
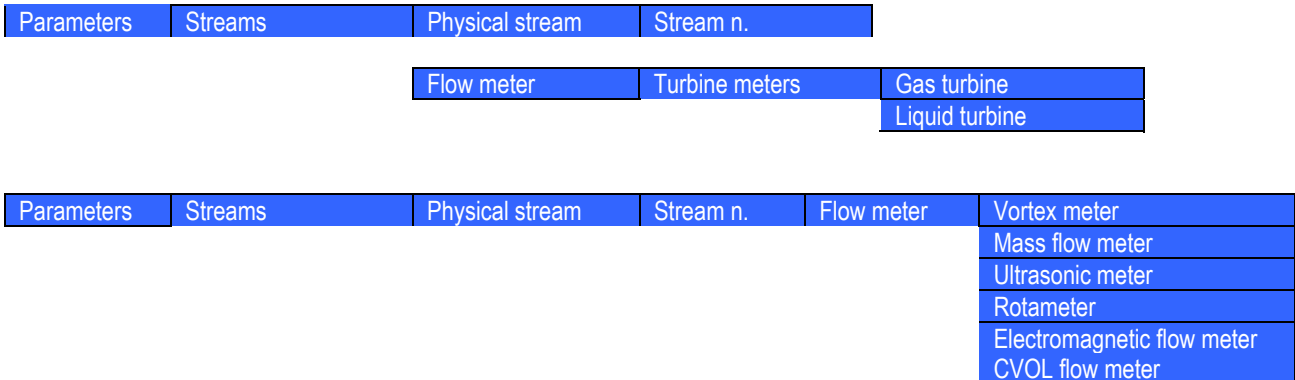

Figure 9-105 Gas turbine meter, Liquid turbine meter, Vortex meter, Mass flow meter, Ultrasonic meter, Rotameter, Electromagnetic meter, CVOL flow meter, Stream data page

The data fields on the data page are as follows:

- Pipe diameter at 20 °C;
Keypad value shall be entered.
- Correction factor;
A multiplier can be entered here to apply to the reading of the meter.
Default value is 1.0.
- Pressure transmitter level correction;
It compensates the hydrostatic pressure of the fluid in the pressure transmitter impulse line. The sign shall be:
plus (+) if the pressure transmitter located above the pressure tapping points
minus (-) if the pressure transmitter located below the pressure tapping points
In case of gas flow measurement the level correction can be neglected.
Keypad value shall be entered.

9.2.2.1.2.6 Flow meter with power characteristic

Route in the menu tree:



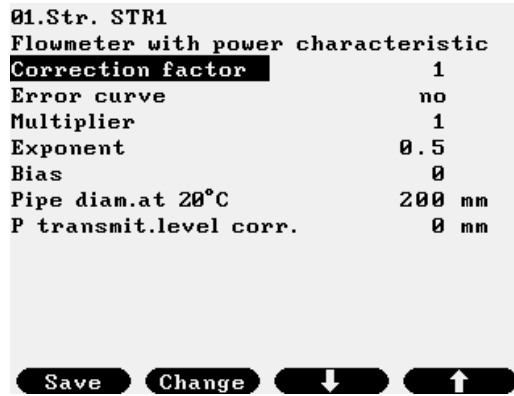

Figure 9-106 Flow meter with power characteristic data page

The equation of this type of flow meter implemented in UNIFLOW-200 is as follows:

$$q_v = MF \cdot (A \cdot J^n + B)$$

where: q_v - volume flow rate, m³/h
 MF - correction factor, -
 A - multiplier, -
 n - exponent, -
 B - bias, -
 J - input signal, %

The data fields on the data page are as follows:

- Correction factor;
 A multiplier can be entered here to apply to the reading of the meter.
 Default value is 1.0.
- Calibration curve;
 Selected from the list:
 - no;
 - yes;
 If calibration curve is enabled then maximum 10 input signal (%) and the corresponding multiplier can be entered here from the calibration certificate of the meter.
 - Input signal n; (n = 1 to 10)
 - Multiplier n; (n = 1 to 10)
- Exponent
- Bias;
- Pipe diameter at 20 °C;
 Keypad value shall be entered.
- Pressure transmitter level correction;

9.2.2.1.2.7 Electric power meter

Route in the menu tree:

Parameters	Streams	Physical stream	Stream 1.	Flow meter	Electric power meter
------------	---------	-----------------	-----------	------------	----------------------

The “Electric power meter” flow meter selection is intended for electrical power measurement. In this case no flow calculation is required. Input signal from electric power meter is received and only totalization is performed, the electric power is totalized.

The unit for the input channel representing the flow rate (in case of the electrical power measurement) shall be selected as MW or MVA in this case.

The fluid shall be selected as “Electric power”.

No data page will appear in this case. Message “Fluid electric power selected” and “Electric power meter selected” will appear on the screen for fluid and flow meter selection respectively.

9.2.2.1.2.8 Stream

Route in the menu tree:

Parameters	Streams	Physical stream	Stream 1.	Flow meter	Stream
------------	---------	-----------------	-----------	------------	--------

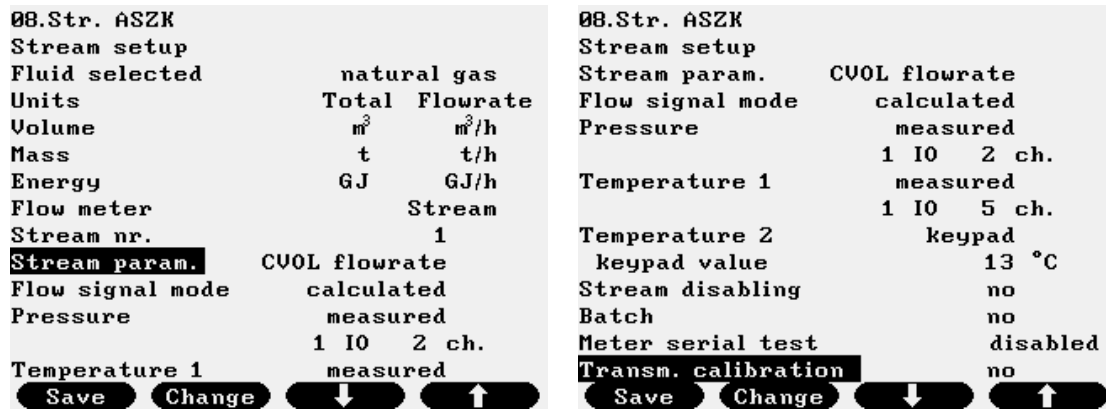

Figure 9-107 Stream flow meter definition in Stream setup menu

The “Stream” flow meter selection is intended for the case when the flow signal is set as volume at line or at base conditions or mass flow rate of any other stream. The assignment of the source stream is done in the Stream setup menu. Example of such measurement is the multi tariff measurement of the gas flow. It means that different flow rate ranges of the gas are totalized in different streams.

9.2.2.1.3 Stream setup

After the fluid and the flow meter are selected the stream setup procedure should be completed.

In the Stream setup menu, the field I/O channels are assigned to the process parameters required in the flow calculation. Some additional parameters required for proper signal processing are entered also.

Depending on the fluid and the flow meter selected specific for that selection Stream setup data page will appear. The number of different fluids and the number of flow meters UNIFLOW-200 is capable to operate with is large. To list all the combinations of fluids and flow meters is not practical, if not impossible here.

Some typical data pages are shown below. They show all of the parameters that appear in setup procedure but maybe in different combination.

It is important to note that the signal setup completed in I/O signal setup section must be synchronized with the stream setup. It means that type of the signal and the unit of measurement selected for the signal must correspond to the signal and unit of measurement required in the flow calculation and the I/O channel assigned to.

The limitations listed below should be observed.

Flow signals:

- differential pressure devices and Annubar;
 - unit: mbar;
 - signal mode: 4-20 mA I/O channel, Modbus channel, keypad
- gas and liquid turbine meter, Vortex meter, ultrasonic meter, electromagnetic flow meter, CVOL flow meter
 - unit: m³/h (at line conditions, at base conditions in case of CVOL flow meter);
 - signal mode: 4-20 mA I/O channel, pulse I/O channel, Modbus channel, keypad
- rotameter;
 - unit: m³/h (at line conditions);
 - signal mode: 4-20 mA I/O channel, Modbus channel, keypad
- mass flow meter;
 - unit: kg/h;
 - signal mode: 4-20 mA I/O channel, pulse I/O channel, Modbus channel, keypad
- flow meter with power characteristic;
 - unit: %;
 - signal mode: 4-20 mA I/O channel, Modbus channel, keypad

Pressure signal

- unit: bar;
- signal mode: 4-20 mA I/O channel, Modbus channel, keypad

Temperature signal

- unit: oC;
- signal mode: 4-20 mA I/O channel, Pt100 I/O channel, Modbus channel, keypad

Density signal

- unit: kg/m³;
- signal mode: 4-20 mA I/O channel, frequency I/O channel, Modbus channel, keypad

Calorific value signal

- unit: MJ/m³ or kg/m³;
- signal mode: 4-20 mA I/O channel, Modbus channel, keypad

Concentration signal

- unit: % (percent);
- signal mode: 4-20 mA I/O channel, Modbus channel, keypad

Duplicated pressure and temperature signals

Uniflow-200 supports duplicated signal assignment to pressure and temperature process parameters. The mode for the pressure and temperature process parameters is selected from the list:

- *keypad* ;
Fixed value is used in the calculation
- *measured* ;
Signal measured at single input channel (4-20 mA or PRT/RTD or HART) is used in the calculation.
- *Modbus signal* ;
Signal received in single Modbus register is used in the calculation.
- *Measured 1-2* ;
Two input channels are assigned to the parameter. First channel is the duty, the second is the stand-by channel. In case if duty channel fails the signal from stand-by channel goes to the calculation.
If both duty and standby signal fail, the keypad value of the duty signal goes to the calculation.
Signals from the two channels are continuously compared. If the deviation between the channels higher than the preset limit, and the deviation exists for period longer than the deviation timeout, then alarm is raised.
Channel numbers and the deviation limit should be entered
 - Signal 1 IO *n* Ch *m1*
 - Signal 2 IO *n* Ch *m2*
 - n* – number of I/O board
 - m* – number of channel on the I/O board
 - Deviation limit (in % of the signal range)
 - Deviation timeout (in s)
- *Modbus 1-2* ;
Two Modbus channels are assigned to the parameter. First channel is the duty, the second is the stand-by channel. In case if duty channel fails the signal from stand-by channel goes to the calculation.
If both duty and standby signal fail, the keypad value of the duty signal goes to the calculation.
Signals from the two channels are continuously compared. If the deviation between the channels higher than the preset limit, and the deviation exists for period longer than the deviation timeout, then alarm is raised.
Channel numbers and the deviation limit should be entered
 - Channel 1 *n1*
 - Channel 2 *n2*
 - n* – number of Modbus channel
 - Deviation limit (in % of the signal range)
 - Deviation timeout (in s)
- *Average 1-2* ;
Two input channels are assigned to the parameter. The average of the two signals goes to the calculation. If one of the channels is failed, the signal from the healthy channel goes to the calculation.
If both signals fail, the keypad value of the first signal goes to the calculation.
Signals from the two channels are continuously compared. If the deviation between the channels higher than the preset limit, and the deviation exists for period longer than the deviation timeout, then alarm is raised.

Channel numbers and the deviation limit should be entered

- Signal 1 IO *n* Ch *m1*
- Signal 2 IO *n* Ch *m2*
- n* – number of I/O board
- m* – number of channel on the I/O board
- Deviation limit (in % of the signal range)
- Deviation timeout (in s)

- Average Modbus 1-2;

Two Modbus channels are assigned to the parameter. The average of the two signals goes to the calculation. If one of the channels is failed, the signal from the healthy channel goes to the calculation.

If both signals fail, the keypad value of the first signal goes to the calculation.

Signals from the two channels are continuously compared. If the deviation between the channels higher than the preset limit, and the deviation exists for period longer than the deviation timeout, then alarm is raised.

Channel numbers and the deviation limit should be entered

- Channel 1 *n1*
- Channel 2 *n2*
- n* – number of Modbus channel
- Deviation limit (in % of the signal range)
- Deviation timeout (in s)

In the Stream setup menu, the unit of measurement for volume, mass and energy shall be selected. In the Table 9-11. below the available units are listed for both metric and imperial systems.

Fluid	Quantity	Metric units		Imperial units	
		Total	Flow rate	Total	Flow rate
Gas	Volume	- m ³ - 10 ³ ·m ³ - 10 ⁶ ·m ³ - l - ml	- m ³ /h - 10 ³ ·m ³ /h - 10 ⁶ ·m ³ /h - l/h - ml/h	- MCF - MMCF	- MCF/h - MMCF/h
	Mass	- kg - g - t	- kg/h - g/h - t/h	- lb	- lb/h
	Energy	- GJ - MJ - kWh - MWh	- GJ/h - MJ/h - kWh/h - MWh/h	- MMBTU	- MMBTU/h
Liquid	Volume	- m ³ - 10 ³ ·m ³ - 10 ⁶ ·m ³ - l - ml	- m ³ /h - 10 ³ ·m ³ /h - 10 ⁶ ·m ³ /h - l/h - ml/h	- bbl	- bbl/h
	Mass	- kg - g - t	- kg/h - g/h - t/h	- Mlb	- Mlb/h
	Energy	- GJ - MJ - kWh - MWh	- GJ/h - MJ/h - kWh/h - MWh/h	- MMBTU	- MMBTU/h
Steam	Volume	- m ³ - 10 ³ ·m ³ - 10 ⁶ ·m ³ - l - ml	- m ³ /h - 10 ³ ·m ³ /h - 10 ⁶ ·m ³ /h - l/h - ml/h	not supported	not supported
	Mass	- kg - g - t	- kg/h - g/h - t/h	not supported	not supported
	Energy	- GJ - MJ - kWh - MWh	- GJ/h - MJ/h - kWh/h - MWh/h	not supported	not supported

Table 9-11 Unit of measurements for volume, mass and energy

Function of the F keys on the Stream setup data pages

⇩ select the next field for editing

⇧ select the previous field for editing

Change modify the selected data field

OK Confirm the selection

Save save the selected/entered data and returns to the parent menu.

9.2.2.1.3.1 Stream setup example – fluid: natural gas, flow meter: orifice meter

Route in the menu tree:

Parameters	Streams	Physical stream	Stream 1.	Stream set up
------------	---------	-----------------	-----------	---------------

01.Str. ASZK1 Stream setup Fluid selected natural gas Units Total Flowrate Volume m ³ m ³ /h Mass kg kg/h Energy GJ GJ/h Flow meter orifice plate Flow signal mode measured No. of dP transm. 2 dP stack type LH dP1L 1 IO 1 ch. dP2H 1 IO 2 ch. Switch up 98 % Save Change ↓ ↑		01.Str. ASZK1 Stream setup Switch up 98 % Switch down 95 % dP cut off 0.1 % Eventing no Pressure measured Signal 1 IO 3 ch. Temperature measured Signal 1 IO 5 ch. Ambient temp. keypad Keypad value 15 °C Stream disabling no Batch no Save Change ↓ ↑	
01.Str. ASZK1 Stream setup dP cut off 0.1 % Eventing no Pressure measured Signal 1 IO 3 ch. Temperature measured Signal 1 IO 5 ch. Ambient temp. keypad Keypad value 15 °C Stream disabling no Batch no Meter serial test disabled Transm. calibration no Save Change ↓ ↑			

Figure 9-108 Stream setup data page, fluid: natural gas, flow meter: orifice meter

07.Str. ASZK Stream setup Eventing no Pressure measured 1 IO 2 ch. Temperature 1 measured 1 IO 5 ch. Temperature 2 keypad Keypad value 15 °C Stream disabling from stream Stream selection 1 Limit to disable lsc - Batch no Meter serial test disabled Save ↓ ↑		08.Str. ASZK Stream setup Stream disabling no Batch no Meter serial test disabled Transm. calibration yes Flow calibration yes Keypad value 111 mbar Pressure calibration yes Keypad value (abs) 11 bar Temp1. calibration yes Keypad value 12 °C Temp2. calibration yes Keypad value 13 °C Save Change ↓ ↑	
--	--	---	--

Figure 9-109 Stream disabling and transmitter calibration data page

The data fields on the data page are as follows:

- Fluid selected;
Not editable here, fixed to the fluid selected in the Fluid menu
- Units;
See the available units for volume, mass and energy in Table 9-11.
- Flow meter;
Not editable here, fixed to the flow meter selected in the Flow meter menu
- Flow signal mode;
The mode selected from the list
 - measured;
It is assumed that differential pressure is measured on input channel(s).
In this case new data entry fields appear to enter the dP transmitter parameters.

- No. of dP transm. (Number of dP transmitters);
Selected from the list;
 - 1 (one differential pressure transmitter);
The I/O channel measuring the differential pressure is entered.
 - dP1 IO *n* Ch *m*
n – number of I/O board
m – number of channel on the I/O board
 - 2 (two differential pressure transmitters);
The configuration of the dP transmitters in case of 2 transmitters:
 - dP stack type
Selected from the list
 - LH (low and high range dP transmitters);
The low or high transmitter reading is used in the flow calculation, depending on the differential pressure measured and the switch down and switch up limits.
The I/O channels measuring the differential pressure is entered.
 - dP1L IO *n* Ch *m*
 - dP2H IO *n* Ch *m*
 - *n* – number of I/O board
m – number of channel on the I/O board
 - Switch up
Switch from low range to high range transmitter in % of the low range transmitter upper range.
 - Switch down
Switch from high range to low range transmitter in % of the low range transmitter upper range.
 - HH (two transmitters with identical range);
The average of the two transmitters reading is used in the flow calculation.
The I/O channels measuring the differential pressure is entered.
 - dP1H IO *n* Ch *m*
 - dP2H IO *n* Ch *m*
 - *n* – number of I/O board
m – number of channel on the I/O board
 - discrepancy (in % of the transmitter range);
Maximum deviation between the readings of the two transmitters.
 - discrepancy timeout (in seconds)
If the discrepancy exists longer then this timeout time, then alarm is raised.
- 3 (three differential pressure transmitters);
The configuration of the dP transmitters in case of 3 transmitters:
 - dP stack type
Selected from the list
 - LMH (low, medium and high range dP transmitters);
The low or medium or high range transmitter reading is used in the flow calculation, depending on the differential pressure measured and the switch down and switch up limits.
The I/O channels measuring the differential pressure is entered.
 - dP1L IO *n* Ch *m*
 - dP2M IO *n* Ch *m*
 - dP3H IO *n* Ch *m*
 - *n* – number of I/O board
m – number of channel on the I/O board
 - Switch up
Switch from low range to medium range transmitter in % of the low range transmitter upper range. Switch from medium range to high range transmitter in % of the medium range transmitter upper range.
 - Switch down
Switch from high range to medium range transmitter in % of the medium range transmitter upper range. Switch from medium range to low range transmitter in % of the low range transmitter upper range.
 - LHH (one low range and two high range transmitters);
The low or high transmitter reading is used in the flow calculation, depending on the differential pressure measured and the switch down and switch up limits. The average of the two high range transmitters reading is used as high dP reading.
The I/O channels measuring the differential pressure is entered.

- dP1L IO *n* Ch *m*
 - dP2H IO *n* Ch *m*
 - dP3H IO *n* Ch *m*
 - n* – number of I/O board
 - m* – number of channel on the I/O board
 - Switch up
Switch from low range to high range transmitter in % of the low range transmitter upper range.
 - Switch down
Switch from high range to low range transmitter in % of the low range transmitter upper range.
 - discrepancy (in % of the transmitter range);
Maximum deviation between the readings of the two high range transmitters.
 - discrepancy timeout (in seconds)
If the discrepancy exists longer then this timeout time, then alarm is raised.
- HHH (three transmitters with identical range);
The average of the three transmitters reading is used in the flow calculation if all the discrepancies are within the limit.
The mid reading is used in the flow calculation if all the discrepancies are outside the limit.
The average of the two closest readings are used in the flow calculation in all other cases.
The I/O channels measuring the differential pressure is entered.
 - dP1H IO *n* Ch *m*
 - dP2H IO *n* Ch *m*
 - dP3H IO *n* Ch *m*
 - n* – number of I/O board
 - m* – number of channel on the I/O board
 - discrepancy (in % of the transmitter range);
Maximum deviation between the readings of any two transmitters.
 - discrepancy timeout (in seconds)
If the discrepancy exists longer then this timeout time, then alarm is raised.
- o modbus sign.;
 - It is assumed that differential pressure signal is received on Modbus channel.
In this case new data entry field appear to enter the dP channel parameters.
 - Channel *n*;
 - n* – number of Modbus channel;
 - o keypad;
 - Keypad flow signal (differential pressure) can be entered here. It serves for testing the flow calculation only.
NOTE
If flow signal is set to keypad the flow rate will be displayed but no totalization will be done.
- dP cut off;
Entered in % of the low range transmitter.
If the measured differential pressure is below the dP cut off limit then the differential pressure is assumed to be zero.
 - Eventing dP cut off;
It is operator selectable if the dP cut off will generate entry in the event log or not.
 - o yes;
 - o no;
 - Pressure signal mode;
The mode selected from the list (for duplicated pressure signals see 9.2.2.1.3.)
 - o measured;
 - It is assumed that pressure is measured on input channel.
The channel number should be entered here.
 - IO *n* Ch *m*
 - n* – number of I/O board
 - m* – number of channel on the I/O board
 - o modb. sign.;
 - It is assumed that pressure signal is received on Modbus channel.
The channel number should be entered here.
 - Channel *n*;
 - n* – number of Modbus channel;
 - o keypad;
 - Keypad pressure can be entered here if pressure signal is not available.

- Temperature signal mode;
The mode selected from the list (for duplicated temperature signals see 9.2.2.1.3.)
 - measured;
It is assumed that temperature is measured on input channel.
The channel number should be entered here.
- IO n Ch m
 n – number of I/O board
 m – number of channel on the I/O board
 - modb. sign. ;
It is assumed that temperature signal is received on Modbus channel.
The channel number should be entered here.
- Channel n ;
 n – number of Modbus channel;
 - keypad;
Keypad temperature can be entered here if temperature signal is not available.
- Ambient temp. signal mode;
Ambient temp. is intended for ambient temperature measurement.
It is not used in flow calculation.
The mode selected from the list
 - measured;
It is assumed that temperature is measured on input channel.
The channel number should be entered here.
- IO n Ch m
 n – number of I/O board
 m – number of channel on the I/O board
 - modb. sign. ;
It is assumed that temperature signal is received on Modbus channel.
The channel number should be entered here.
- Channel n ;
 n – number of Modbus channel;
 - keypad;
Keypad temperature can be entered here if temperature signal is not available.
Live it to keypad value if no ambient temperature measurement is required.
- Stream disabling;
It is possible to disable the operation of the stream depending on different parameters.
The option is selected from the list:
 - no;
Stream never disabled.
 - input signal ;
Any I/O channel signal can be selected. One lower limit and one upper limit can be selected to disable the stream. The lower limit is selected from lsc, lo, lolo or none.
The upper limit is selected from hsc, hi, hihi or none
The channel number and the limit causing the stream disabled should be entered here.
- IO n Ch m ;
 n – number of I/O board
 m – number of channel on the I/O board
- Limit to disable;
Lower limit
 - lo (low alarm limit of the I/O channel);
 - lolo (low-low alarm limit of the I/O channel);
 - lsc (low scale of the I/O channel);
 - - (no lower limit will disable the stream);
 Upper limit
 - hi (high alarm limit of the I/O channel);
 - hihi (high-high alarm limit of the I/O channel);
 - hsc (high scale of the I/O channel);
 - - (no upper limit will disable the stream);
 - modbus signal ;
Any Modbus channel signal can be selected. One lower limit and one upper limit can be selected to disable the stream. The lower limit is selected from lsc, lo, lolo or none.
The upper limit is selected from hsc, hi, hihi or none.
The channel number and the limit causing the stream disabled should be entered here.

- Channel *n*,
n – number of Modbus channel;
- Limit to disable;
Lower limit
 - lo (low alarm limit of the Modbus channel);
 - lolo (low-low alarm limit of the Modbus channel);
 - lsc (low scale of the Modbus channel);
 - - (no lower limit will disable the stream);
 Upper limit
 - hi (high alarm limit of the Modbus channel);
 - hihi (high-high alarm limit of the Modbus channel);
 - hsc (high scale of the Modbus channel);
 - - (no upper limit will disable the stream);
- o from stream;
Any stream can be selected.
One lower limit and one upper limit can be selected to disable the stream. The lower limit is selected from lsc, lo, lolo or none.
The upper limit is selected from hsc, hi, hihi or none.
The stream number and the limit causing the stream disabled should be entered here.
 - Stream *n*,
n – serial number of the stream from 1 to 12;
 - Limit to disable;
Lower limit
 - lo (low alarm limit of the Stream *n*);
 - lolo (low-low alarm limit of the Stream *n*);
 - lsc (low scale of the Stream *n*);
 - - (no lower limit will disable the stream);
 Upper limit
 - hi (high alarm limit of the Modbus channel);
 - hihi (high-high alarm limit of the Modbus channel);
 - hsc (high scale of the Modbus channel);
 - - (no upper limit will disable the stream);
 The values of the upper and lower limits are set in the Limits menu of the Stream *n* being the stream disabling the current stream. The type of flow rate (volume at line or at base conditions, mass or energy flow rate) is selected also in the Limits menu of the Stream *n*. See 9.2.2.1.5.
- Batch;
Batch measurement is enabled or disabled here.
The option is selected from the list:
 - o no;
No batch measurement performed.
 - o yes;
Batch measurement is enabled. New data entry lines appear where the parameters of the batch measurement shall be entered.
 - Batch start/stop
The batch start/stop method is selected here from the list of options:
 - from communication interface;
The batch measurement starts and stops by writing certain Modbus registers. The mapping of the start/stop Modbus registers and also the registers where the measured data can be read from see in 10.5.2.
 - start key/required quantity;
The batch measurement starts with pulse (pulse length min. 1 s) applied to the appropriate digital input. The batch measurements stops when the required quantity (mass or volume) passed the meter run. The batch measurement can be stopped in case of emergency applying pulse (pulse length min. 1 s) to the appropriate digital input.
In case of this start/stop method, new data entry lines appear as follows:
 - Required quantity
Selected from the list:
 - uncorr. volume (required quantity is entered in volume units at line conditions);
 - mass (required quantity is entered in mass units);
 - Batch quantity
Numeric entry field to enter the required batch quantity.

- Batch start input (digital input channel to start batch measurement)
 - IO n Ch m
 - n – number of I/O board
 - m – number of channel on the I/O board
- Batch stop input (digital input channel to stop batch measurement in case of emergency)
 - IO n Ch m
 - n – number of I/O board
 - m – number of channel on the I/O board
- Batch control input (digital output channel set to active state during the batch measurement)
 - IO n Ch m
 - n – number of I/O board
 - m – number of channel on the I/O board
- daily batch measurement ;
 The batch measurement starts at the defined hour of day and lasts 24 hours (one day). After one day finished the batch measurement for the next day starts automatically. Batch report generated after each day. By this setting second set of daily counters can be defined, which are independent from the standard daily counters and the start hour of this daily batch is also independent from the general starting hour of the day.
 In case of this start/stop method, new data entry lines appear as follows:
 - Start hour of daily batch
 Numeric entry field to enter the start hour of the daily batch measurement. Valid entries are from 0 to 23.
- Batch type
 The type of batch measurement is selected here from the list of options:
 - Tank loading/unloading ;
 Conventional tank loading batch measurement (see 9.1.7.1).
 - Pipeline product interface ;
 Different kind of fluids flowing in the same pipeline each after other measured as batches (see 9.1.7.2).
 Available only if batch start/stop method is “from communication interface”.
 In case to Pipeline product interface batch type new data entry line appear:
- Product info
 Entering into this entry line new data entry display appears where up to 16 different product type and the corresponding density at base conditions shall be entered. See also in 9.2.2.1.1.5. Liquids.

The name of the stream entered in 9.2.2.1. will be displayed on the batch report as station name. To display the results of the batch measurements, see 9.1.7.

- Meter serial test
 Flow meter serial test measurement can be enabled or disabled here.
 The option is selected from the list:
 - o disabled ;
 No flow meter serial test measurement performed.
 - o meter serial test ;
 Flow meter serial test measurement is enabled.
 Serial test can be enabled on Stream 1 only.
 Warning message appears:
 Proceeding will reset all totals and parameters of stream 8. Proceed?
 Selecting yes two new lines appear.
 - Shadow stream 8
 In the non-custody transfer flow computer, the measured values and totals are displayed in stream 8.
 - Stream
 The option is selected from the list:
 - custody transfer stream (slave);
 The stream being set up will perform the custody transfer measurement during the serial test. It will operate in normal way. In the data exchange between the two flow computers taking part in the flow meter serial test this flow computer will be the slave device.
 - non custody transfer stream (master);
 The stream being set up will perform non custody transfer measurement during the serial test. It will display and totalize the flow in stream 8 instead of the stream being configured for the particular meter run. In the data exchange between the two flow computers taking part in the flow meter serial test this flow computer will be the master device.

- flow computer calibration;
The flow computer calibration is a special subset of the meter serial test.
Selecting this option:
 - the stream 8 will be the shadow stream;
 - Uniflow-200 will be the Master device in the calibration.

See details of the meter serial test measurements and the flow computer calibration in 9.1.8.

- Transmitter calibration
Calibration of the transmitters can be enabled or disabled here. When calibration is enabled for a certain transmitter keypad value shall be entered for the parameter being measured by that transmitter. In this case, the flow calculation will be performed with the keypad value of the parameter. The measured value of the input signal is still displayed in the Flow / Plant I/O / IO Board x menu allowing the calibration of the transmitter without interrupting the flow measurement. NOTE: the transmitter calibration shall be disabled after finishing the transmitter calibration to recover the normal operation of the flow computer.
The option is selected from the list:
 - no;
transmitters operate in normal way.
 - yes;
transmitters are being calibrated. If the yes option is selected 4 new menu item appears allowing selection of the transmitters one by one, namely:
 - Flow meter
 - no;
flow meter operates in normal way.
 - yes;
flow meter is being calibrated.
 - Keypad value
keypad value to be used in the calculation during the transmitter calibration shall be entered.
 - Pressure
 - no;
pressure transmitter operates in normal way.
 - yes;
pressure transmitter is being calibrated.
 - Keypad value
keypad value to be used in the calculation during the transmitter calibration shall be entered.
 - Temperature
 - no;
temperature 1 transmitter operates in normal way.
 - yes;
temperature 1 transmitter is being calibrated.
 - Keypad value
keypad value to be used in the calculation during the transmitter calibration shall be entered.
 - Ambient temp.
 - no;
ambient temp. transmitter operates in normal way.
 - yes;
temperature 2 transmitter is being calibrated.
 - Keypad value
keypad value to be used in the calculation during the transmitter calibration shall be entered.

9.2.2.1.3.2 Stream setup example – fluid: natural gas, flow meter: turbine meter

Route in the menu tree:

Parameters	Streams	Physical stream	Stream 1.	Stream set up
------------	---------	-----------------	-----------	---------------

Ø2.Str. ASZK2			Ø2.Str. ASZK2		
Stream setup			Stream setup		
Fluid selected	natural gas		Eventing		
Units	Total Flowrate		measured		
Volume	m ³	m ³ /h	Pressure	measured	
Mass	kg	kg/h	Signal	1 IO 3 ch.	
Energy	GJ	GJ/h	Temperature	measured	
Flow meter	turbine meter		Signal	1 IO 5 ch.	
Flow signal mode	measured		Ambient temp.	keypad	
Signal	3 IO	1 ch.	Keypad value	15 °C	
Check signal	measured		LF pulse counter	no	
Signal	3 IO	2 ch.	Stream disabling	no	
Signal ratio	1		Batch	no	
Cut off	0.1 %		Meter serial test	disabled	
Save	Change	↓	↑	Save	Change

Figure 9-110 Stream setup data page, fluid: natural gas, flow meter: turbine meter

The data fields on the data page are as follows:

- Fluid selected;
Not editable here, fixed to the fluid selected in the Fluid menu
- Units;
See the available units for volume, mass and energy in Table 9-11.
- Flow meter;
Not editable here, fixed to the flow meter selected in the Flow meter menu
- Flow signal mode;
The mode selected from the list
 - measured;
It is assumed that flow signal is measured on input channel(s).
Valid input channels for selection:
 - high frequency input channels (pulse input channels of PDIO484 or PITC4641 board)
 - digital input channels with signal type set to "Pulse" (digital input channels of PDIO484, PITC4641 and AODIO484 boards)
 In this case the I/O channel measuring the flow signal shall be entered.
 - IO *n*Ch *m*
 - n* – number of I/O board
 - m* – number of channel on the I/O board
 - modb. sign.;;
It is assumed that flow signal is received on Modbus channel..
In this case new data entry field appear to enter the flow signal channel parameters.
 - Channel *n*;
 - n* – number of Modbus channel;
 - keypad;
Keypad flow signal can be entered here. It serves for testing the flow calculation only.
NOTE
If flow signal is set to keypad the flow rate will be displayed but no totalization will be done.
- Check signal mode;
Check signal mode entry field appears in the next line.
The mode selected from the list
 - no;
No check signal (second pulse train from the turbine meter) exists.
 - measured;
In this case the I/O channel measuring the check signal shall be entered.
 - IO *n*Ch *m*
 - n* – number of I/O board
 - m* – number of channel on the I/O board
- Signal ratio;
The ratio of the Main signal frequency to the Check signal frequency shall be entered here.
- Cut off;
Entered in % of the maximum UVOL flow rate as defined in the signal setup menu.
If the measured flow rate is below the Cut off limit then the flow rate is assumed to be zero.
- Eventing cut off;
It is operator selectable if the Cut off will generate entry in the event log or not.
 - yes;
 - no;

- Pressure signal mode;
The mode selected from the list (for duplicated pressure signals see 9.2.2.1.3.)
 - measured;
It is assumed that pressure is measured on input channel.
The channel number should be entered here.
 - IO n Ch m
 n – number of I/O board
 m – number of channel on the I/O board
 - modb. sign. ;
It is assumed that pressure signal is received on Modbus channel.
The channel number should be entered here.
 - Channel n ,
 n – number of Modbus channel;
 - keypad;
Keypad pressure can be entered here if pressure signal is not available.
- Temperature signal mode;
The mode selected from the list (for duplicated temperature signals see 9.2.2.1.3.)
 - measured;
It is assumed that temperature is measured on input channel.
The channel number should be entered here.
 - IO n Ch m
 n – number of I/O board
 m – number of channel on the I/O board
 - modb. sign. ;
It is assumed that temperature signal is received on Modbus channel.
The channel number should be entered here.
 - Channel n ,
 n – number of Modbus channel;
 - keypad;
Keypad temperature can be entered here if temperature signal is not available.
- Ambient temp. signal mode;
Ambient temp. is intended for ambient temperature measurement.
It is not used in flow calculation.
The mode selected from the list
 - measured;
It is assumed that temperature is measured on input channel.
The channel number should be entered here.
 - IO n Ch m
 n – number of I/O board
 m – number of channel on the I/O board
 - modb. sign. ;
It is assumed that temperature signal is received on Modbus channel.
The channel number should be entered here.
 - Channel n ,
 n – number of Modbus channel;
 - keypad;
Keypad temperature can be entered here if temperature signal is not available.
Live it to keypad value if no ambient temperature measurement is required.
- LF (low frequency) pulse counter
Available only if flow signal mode is “measured”.
For the metering streams having high frequency flow signals from volume flow meters or mas flow meters an LF counter can be defined. E. g. in case of turbine meter the low frequency pulse output connected to digital input channel, can be assigned to the LF counter of the stream.
The LF counter has only cumulative total counter, it has no periodic total counters.
LF pulse cumulative total counter is available (if defined)
 - on cumulative totals data page;
 - on the Snapshot report;
 - on the Modbus Slave channel when Daniel Modbus or User Modbus is defined (not available in standard Modbus);
 - on User defined reports (defined report 11 to 18).
 The aim of this counter is to repeat the mechanical counter located in the counter head of the turbine meter.
The K-factor of the low frequency output shall be set in the signal setup page of the digital input, the LF output connected to. So that the LF counter will repeat the volume/mass indicated on the meter counter.

It is not used in flow calculation.

The mode selected from the list

- o `measured;`
It is assumed that low frequency signal is measured on input channel.
The channel number should be entered here.
- `IO n Ch m`
`n` – number of I/O board
`m` – number of channel on the I/O board
- o `no;`
No LF signal is connected, no LF pulse counter will be available.

- Stream disabling;

It is possible to disable the operation of the stream depending on different parameters.

The option is selected from the list:

- o `no;`
Stream never disabled.
- o `input signal;`
Any I/O channel signal can be selected. One lower limit and one upper limit can be selected to disable the stream. The lower limit is selected from `lsc`, `lo`, `lolo` or `none`.
The upper limit is selected from `hsc`, `hi`, `hihi` or `none`.
The channel number and the limit causing the stream disabled should be entered here.
- `IO n Ch m,`
`n` – number of I/O board
`m` – number of channel on the I/O board
- Limit to disable;
Lower limit
- `lo` (low alarm limit of the I/O channel);
- `lolo` (low-low alarm limit of the I/O channel);
- `lsc` (low scale of the I/O channel);
- `-` (no lower limit will disable the stream);
Upper limit
- `hi` (high alarm limit of the I/O channel);
- `hihi` (high-high alarm limit of the I/O channel);
- `hsc` (high scale of the I/O channel);
- `-` (no upper limit will disable the stream);
- o `modbus signal;`
Any Modbus channel signal can be selected. One lower limit and one upper limit can be selected to disable the stream. The lower limit is selected from `lsc`, `lo`, `lolo` or `none`.
The upper limit is selected from `hsc`, `hi`, `hihi` or `none`.
The channel number and the limit causing the stream disabled should be entered here.
- Channel `n,`
`n` – number of Modbus channel;
- Limit to disable;
Lower limit
- `lo` (low alarm limit of the Modbus channel);
- `lolo` (low-low alarm limit of the Modbus channel);
- `lsc` (low scale of the Modbus channel);
- `-` (no lower limit will disable the stream);
Upper limit
- `hi` (high alarm limit of the Modbus channel);
- `hihi` (high-high alarm limit of the Modbus channel);
- `hsc` (high scale of the Modbus channel);
- `-` (no upper limit will disable the stream);
- o `from stream;`
Any stream can be selected.
One lower limit and one upper limit can be selected to disable the stream. The lower limit is selected from `lsc`, `lo`, `lolo` or `none`.
The upper limit is selected from `hsc`, `hi`, `hihi` or `none`.
The stream number and the limit causing the stream disabled should be entered here.
- Stream `n,`
`n` – serial number of the stream from 1 to 12;
- Limit to disable;

Lower limit

- lo (low alarm limit of the Stream *n*);
- lolol (low-low alarm limit of the Stream *n*);
- lsc (low scale of the Stream *n*);
- - (no lower limit will disable the stream);

Upper limit

- hi (high alarm limit of the Modbus channel);
- hihi (high-high alarm limit of the Modbus channel);
- hsc (high scale of the Modbus channel);
- - (no upper limit will disable the stream);

The values of the upper and lower limits are set in the Limits menu of the Stream *n* being the stream disabling the current stream. The type of flow rate (volume at line or at base conditions, mass or energy flow rate) is selected also in the Limits menu of the Stream *n*. See 9.2.2.1.5.

- Batch;

Batch measurement is enabled or disabled here.

The option is selected from the list:

- o no;

No batch measurement performed.

- o yes;

Batch measurement is enabled. New data entry lines appear where the parameters of the batch measurement shall be entered.

- Batch start/stop

The batch start/stop method is selected here from the list of options:

- from communication interface;

The batch measurement starts and stops by writing certain Modbus registers. The mapping of the start/stop Modbus registers and also the registers where the measured data can be read from see in 10.5.2.

- start key/required quantity;

The batch measurement starts with pulse (pulse length min. 1 s) applied to the appropriate digital input.

The batch measurements stops when the required quantity (mass or volume) passed the meter run. The batch measurement can be stopped in case of emergency applying pulse (pulse length min. 1 s) to the appropriate digital input.

In case of this start/stop method, new data entry lines appear as follows:

- Required quantity

Selected from the list:

- uncorr. volume (required quantity is entered in volume units at line conditions);
- mass (required quantity is entered in mass units);

- Batch quantity

Numeric entry field to enter the required batch quantity.

- Batch start input (digital input channel to start batch measurement)

- IO *n* Ch *m*

n – number of I/O board

m – number of channel on the I/O board

- Batch stop input (digital input channel to stop batch measurement in case of emergency)

- IO *n* Ch *m*

n – number of I/O board

m – number of channel on the I/O board

- Batch control input (digital output channel set to active state during the batch measurement)

- IO *n* Ch *m*

n – number of I/O board

m – number of channel on the I/O board

- daily batch measurement;

The batch measurement starts at the defined hour of day and lasts 24 hours (one day). After one day finished the batch measurement for the next day starts automatically. Batch report generated after each day. By this setting second set of daily counters can be defined, which are independent from the standard daily counters and the start hour of this daily batch is also independent from the general starting hour of the day.

In case of this start/stop method, new data entry lines appear as follows:

- Start hour of daily batch

Numeric entry field to enter the start hour of the daily batch measurement. Valid entries are from 0 to 23.

- **Batch type**
The type of batch measurement is selected here from the list of options:
 - Tank loading/unloading;
Conventional tank loading batch measurement (see 9.1.7.1).
 - Pipeline product interface;
Different kind of fluids flowing in the same pipeline each after other measured as batches (see 9.1.7.2).
Available only if batch start/stop method is "from communication interface".
In case to Pipeline product interface batch type new data entry line appear:
- **Product info**
Entering into this entry line new data entry display appears where up to 16 different product type and the corresponding density at base conditions shall be entered. See also in 9.2.2.1.1.5. Liquids.

The name of the stream entered in 9.2.2.1. will be displayed on the batch report as station name. To display the results of the batch measurements, see 9.1.7.

- **Meter serial test**
Flow meter serial test measurement can be enabled or disabled here.
Serial test can be enabled on Stream 1 only.
The option is selected from the list:
 - o disabled;
No flow meter serial test measurement performed.
 - o meter serial test;
Flow meter serial test measurement is enabled.
Serial test can be enabled on Stream 1 only.
Warning message appears:
Proceeding will reset all totals and parameters of stream 8. Proceed?
Selecting yes two new lines appear.
 - Shadow stream 8
In the non custody transfer flow computer the measured values and totals are displayed in stream 8.
 - Stream
The option is selected from the list:
 - custody transfer stream (slave);
The stream being set up will perform the custody transfer measurement during the serial test. It will operate in normal way. In the data exchange between the two flow computers taking part in the flow meter serial test this flow computer will be the slave device.
 - non custody transfer stream (master);
The stream being set up will perform non custody transfer measurement during the serial test. It will display and totalize the flow in stream 8 instead of the stream being configured for the particular meter run. In the data exchange between the two flow computers taking part in the flow meter serial test this flow computer will be the master device.
 - o flow computer calibration;
The flow computer calibration is a special subset of the meter serial test.
Selecting this option:
 - the stream 8 will be the shadow stream;
 - Uniflow-200 will be the Master device in the calibration.
- See details of the meter serial test measurements and the flow computer calibration in 9.1.8.

- **Transmitter calibration**
Calibration of the transmitters can be enabled or disabled here. When calibration is enabled for a certain transmitter keypad value shall be entered for the parameter being measured by that transmitter. In this case the flow calculation will be performed with the keypad value of the parameter. The measured value of the input signal is still displayed in the Flow / Plant I/O / IO Board x menu allowing the calibration of the transmitter without interrupting the flow measurement.
NOTE: the transmitter calibration shall be disabled after finishing the transmitter calibration to recover the normal operation of the flowcomputer.
The option is selected from the list:
 - o no;
transmitters operate in normal way.
 - o yes;
transmitters are being calibrated. If the yes option is selected 4 new menu item appears allowing selection of the transmitters one by one, namely:

- Flow meter
 - no;
flow meter operates in normal way.
 - yes;
flow meter is being calibrated.
 - Keypad value
keypad value to be used in the calculation during the transmitter calibration shall be entered.
- Pressure
 - no;
pressure transmitter operates in normal way.
 - yes;
pressure transmitter is being calibrated.
 - Keypad value
keypad value to be used in the calculation during the transmitter calibration shall be entered.
- Temperature
 - no;
temperature 1 transmitter operates in normal way.
 - yes;
temperature 1 transmitter is being calibrated.
 - Keypad value
keypad value to be used in the calculation during the transmitter calibration shall be entered.
- Ambient temp.
 - no;
ambient temp. transmitter operates in normal way.
 - yes;
ambient temp. transmitter is being calibrated.
 - Keypad value
keypad value to be used in the calculation during the transmitter calibration shall be entered.

9.2.2.1.3.3 Stream setup example – fluid: natural gas, flow meter: ultrasonic meter

Route in the menu tree:

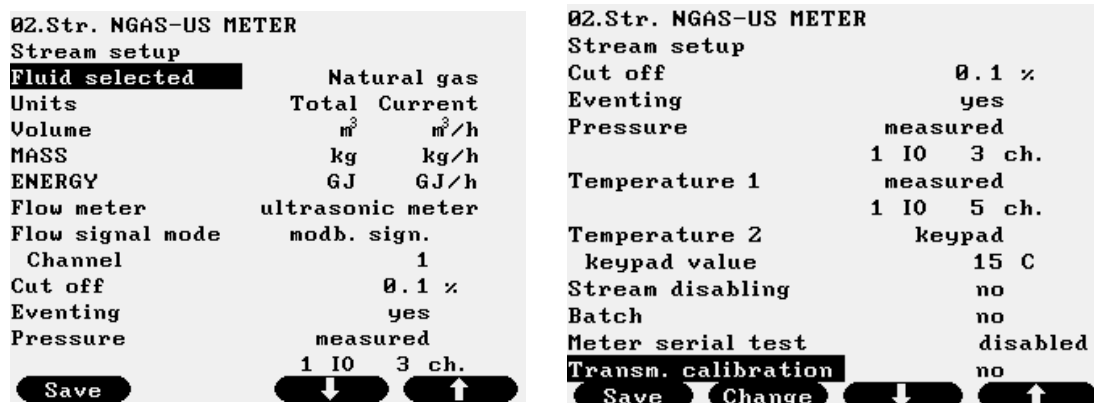

Figure 9-111 Stream setup data page, fluid: natural gas, flow meter: ultrasonic meter

The data fields on the data page are as follows:

- Fluid selected;
Not editable here, fixed to the fluid selected in the Fluid menu
- Units;
See the available units for volume, mass and energy in Table 9-11.
- Flow meter selected;
Not editable here, fixed to the flow meter selected in the Flow meter menu

- Flow signal mode;
The mode selected from the list
 - `measured`;
It is assumed that the flow signal is measured on analog input channel.
The channel number entered here.
- IO n Ch m ;
 n – number of I/O board
 m – number of channel on the I/O board
 - `modb. sign.` (measured at Modbus channel);
It is assumed that the flow signal is received on Modbus channel. This is the case when UNIFLOW-200 reads volume flow rate data from ultrasonic meter on modbus link.
In this case new data entry field appear to enter the flow signal channel parameters.
- Channel n ;
 n – number of Modbus channel;
 - `keypad`;
Keypad flow signal (volume flow rate at line conditions) can be entered here. It serves for testing the flow calculation only.
NOTE
If flow signal is set to keypad the flow rate will be displayed but no totalization will be done.
- Cut off (Low flow cut off);
Entered in % of the high range of the flow signal input channel.
If the measured flow is below the low flow cut off limit then the flow is assumed to be zero.
- Eventing low flow cut off;
It is operator selectable if the low flow cut off will generate entry in the event log or not.
 - `yes`;
 - `no`;
- Pressure signal mode;
The mode selected from the list (for duplicated pressure signals see 9.2.2.1.3.)
 - `measured`;
It is assumed that pressure is measured on input channel.
The channel number should be entered here.
- IO n Ch m
 n – number of I/O board
 m – number of channel on the I/O board
 - `modb. sign.` (measured at Modbus channel);
It is assumed that pressure signal is received on Modbus channel.
The channel number should be entered here.
- Channel n ;
 n – number of Modbus channel;
 - `keypad`;
Keypad pressure can be entered here if pressure signal is not available.
- Temperature1 signal mode;
The mode selected from the list (for duplicated temperature signals see 9.2.2.1.3.)
 - `measured`;
It is assumed that temperature is measured on input channel.
The channel number should be entered here.
- IO n Ch m
 n – number of I/O board
 m – number of channel on the I/O board
 - `modb. sign.` (measured at Modbus channel);
It is assumed that temperature signal is received on Modbus channel.
The channel number should be entered here.
- Channel n ;
 n – number of Modbus channel;
 - `keypad`;
Keypad temperature can be entered here if temperature signal is not available.
- Ambient temp. signal mode;
Ambient temp. is intended for ambient temperature measurement.
It is not used in flow calculation.
The mode selected from the list
 - `measured`;
It is assumed that temperature is measured on input channel.
The channel number should be entered here.

- IO n Ch m
 n – number of I/O board
 m – number of channel on the I/O board
- o modb. sign. i
 It is assumed that temperature signal is received on Modbus channel.
 The channel number should be entered here.
 - Channel n ,
 n – number of Modbus channel;
- o keypad;
 Keypad temperature can be entered here if temperature signal is not available.
 Live it to keypad value if no ambient temperature measurement is required.
- Stream disabling;
 It is possible to disable the operation of the stream depending on different parameters.
 The option is selected from the list:
 - o no;
 Stream never disabled.
 - o input signal;
 Any I/O channel signal can be selected. One lower limit and one upper limit can be selected to disable the stream. The lower limit is selected from lsc, lo, lolo or none.
 The upper limit is selected from hsc, hi, hihi or none
 The channel number and the limit causing the stream disabled should be entered here.
 - IO n Ch m ,
 n – number of I/O board
 m – number of channel on the I/O board
 - Limit to disable;
 Lower limit
 - lo (low alarm limit of the I/O channel);
 - lololo (low-low alarm limit of the I/O channel);
 - lsc (low scale of the I/O channel);
 - - (no lower limit will disable the stream);
 Upper limit
 - hi (high alarm limit of the I/O channel);
 - hihi (high-high alarm limit of the I/O channel);
 - hsc (high scale of the I/O channel);
 - - (no upper limit will disable the stream);
 - o modbus signal;
 Any Modbus channel signal can be selected. One lower limit and one upper limit can be selected to disable the stream. The lower limit is selected from lsc, lo, lolo or none.
 The upper limit is selected from hsc, hi, hihi or none.
 The channel number and the limit causing the stream disabled should be entered here.
 - Channel n ,
 n – number of Modbus channel;
 - Limit to disable;
 Lower limit
 - lo (low alarm limit of the Modbus channel);
 - lololo (low-low alarm limit of the Modbus channel);
 - lsc (low scale of the Modbus channel);
 - - (no lower limit will disable the stream);
 Upper limit
 - hi (high alarm limit of the Modbus channel);
 - hihi (high-high alarm limit of the Modbus channel);
 - hsc (high scale of the Modbus channel);
 - - (no upper limit will disable the stream);
 - o from stream;
 Any stream can be selected.
 One lower limit and one upper limit can be selected to disable the stream. The lower limit is selected from lsc, lo, lolo or none.
 The upper limit is selected from hsc, hi, hihi or none.
 The stream number and the limit causing the stream disabled should be entered here.
 - Stream n ,
 n – serial number of the stream from 1 to 12;
 Limit to disable;

- Lower limit
 - `lo` (low alarm limit of the Stream n);
 - `lolo` (low-low alarm limit of the Stream n);
 - `lsc` (low scale of the Stream n);
 - - no lower limit will disable the stream);
- Upper limit
 - `hi` (high alarm limit of the Stream n);
 - `hihi` (high-high alarm limit of the Stream n);
 - `hsc` (high scale of the Stream n);
 - - (no upper limit will disable the stream);

The values of the upper and lower limits are set in the Limits menu of the Stream n being the stream disabling the current stream. The type of flow rate (volume at line or at base conditions, mass or energy flow rate) is selected also in the Limits menu of the Stream n . See 9.2.2.1.5.

- Batch;

Batch measurement is enabled or disabled here.
The option is selected from the list:

 - `no`;
No batch measurement performed.
 - `yes`;
Batch measurement is enabled. New data entry lines appear where the parameters of the batch measurement shall be entered.
 - Batch start/stop
The batch start/stop method is selected here from the list of options:
 - `from communication interface`;
The batch measurement starts and stops by writing certain Modbus registers. The mapping of the start/stop Modbus registers and also the registers where the measured data can be read from see in 10.5.2.
 - `start key/required quantity`;
The batch measurement starts with pulse (pulse length min. 1 s) applied to the appropriate digital input. The batch measurements stops when the required quantity (mass or volume) passed the meter run. The batch measurement can be stopped in case of emergency applying pulse (pulse length min. 1 s) to the appropriate digital input.
In case of this start/stop method, new data entry lines appear as follows:
 - Required quantity
Selected from the list:
 - `uncorr. volume` (required quantity is entered in volume units at line conditions);
 - `mass` (required quantity is entered in mass units);
 - Batch quantity
Numeric entry field to enter the required batch quantity.
 - Batch start input (digital input channel to start batch measurement)
 - `IO n Ch m`
 n – number of I/O board
 m – number of channel on the I/O board
 - Batch stop input (digital input channel to stop batch measurement in case of emergency)
 - `IO n Ch m`
 n – number of I/O board
 m – number of channel on the I/O board
 - Batch control input (digital output channel set to active state during the batch measurement)
 - `IO n Ch m`
 n – number of I/O board
 m – number of channel on the I/O board
 - `daily batch measurement`;
The batch measurement starts at the defined hour of day and lasts 24 hours (one day). After one day finished the batch measurement for the next day starts automatically. Batch report generated after each day. By this setting second set of daily counters can be defined, which are independent from the standard daily counters and the start hour of this daily batch is also independent from the general starting hour of the day.
In case of this start/stop method, new data entry lines appear as follows:
 - Start hour of daily batch

Numeric entry field to enter the start hour of the daily batch measurement. Valid entries are from 0 to 23.

- **Batch type**
The type of batch measurement is selected here from the list of options:
 - Tank loading/unloading;
Conventional tank loading batch measurement (see 9.1.7.1).
 - Pipeline product interface;
Different kind of fluids flowing in the same pipeline each after other measured as batches (see 9.1.7.2).
Available only if batch start/stop method is "from communication interface".
In case to Pipeline product interface batch type new data entry line appear:
- **Product info**
Entering into this entry line new data entry display appears where up to 16 different product type and the corresponding density at base conditions shall be entered. See also in 9.2.2.1.1.5. Liquids.

The name of the stream entered in 9.2.2.1. will be displayed on the batch report as station name. To display the results of the batch measurements see 9.1.7.

- **Meter serial test**
Flow meter serial test measurement can be enabled or disabled here.
The option is selected from the list:
 - o disabled;
No flow meter serial test measurement performed.
 - o meter serial test;
Flow meter serial test measurement is enabled.
Serial test can be enabled on Stream 1 only.
Warning message appears:
Proceeding will reset all totals and parameters of stream 8. Proceed?
Selecting yes two new lines appear.
 - Shadow stream 8
In the non custody transfer flow computer the measured values and totals are displayed in stream 8.
 - Stream
The option is selected from the list:
 - custody transfer stream (slave);
The stream being set up will perform the custody transfer measurement during the serial test. It will operate in normal way. In the data exchange between the two flow computers taking part in the flow meter serial test this flow computer will be the slave device.
 - non custody transfer stream (master);
The stream being set up will perform non custody transfer measurement during the serial test. It will display and totalize the flow in stream 8 instead of the stream being configured for the particular meter run. In the data exchange between the two flow computers taking part in the flow meter serial test this flow computer will be the master device.
 - o flow computer calibration;
The flow computer calibration is a special subset of the meter serial test.
Selecting this option:
 - the stream 8 will be the shadow stream;
 - Uniflow-200 will be the Master device in the calibration.

See details of the meter serial test measurements and the flow computer calibration in 9.1.8.

- **Transmitter calibration**
Calibration of the transmitters can be enabled or disabled here. When calibration is enabled for a certain transmitter keypad value shall be entered for the parameter being measured by that transmitter. In this case the flow calculation will be performed with the keypad value of the parameter. The measured value of the input signal is still displayed in the Flow / Plant I/O / IO Board x menu allowing the calibration of the transmitter without interrupting the flow measurement.
NOTE: the transmitter calibration shall be disabled after finishing the transmitter calibration to recover the normal operation of the flow computer.
The option is selected from the list:
 - o no;
transmitters operate in normal way.
 - o yes;
transmitters are being calibrated. If the yes option is selected 4 new menu item appears allowing selection of the transmitters one by one, namely:
 - Flow meter

- no;
flow meter operates in normal way.
- yes;
flow meter is being calibrated.
 - Keypad value
keypad value to be used in the calculation during the transmitter calibration shall be entered.
- Pressure
 - no;
pressure transmitter operates in normal way.
 - yes;
pressure transmitter is being calibrated.
 - Keypad value
keypad value to be used in the calculation during the transmitter calibration shall be entered.
- Temperature 1
 - no;
temperature 1 transmitter operates in normal way.
 - yes;
temperature 1 transmitter is being calibrated.
 - Keypad value
keypad value to be used in the calculation during the transmitter calibration shall be entered.
- Temperature 2
 - no;
temperature 2 transmitter operates in normal way.
 - yes;
temperature 2 transmitter is being calibrated.
 - Keypad value
keypad value to be used in the calculation during the transmitter calibration shall be entered.
- Ultrasonic meter path performance limit
The path performance % is read from the ultrasonic meter for each path.
Operator can set an alarm limit for path performance here. If the performance of any path is lower than alarm limit, an alarm raised.
It is selectable if in case of active alarm limit stream shall be switched to fault state or not.

9.2.2.1.3.4 Stream setup example – fluid: crude oil, flow meter: liquid turbine meter

Route in the menu tree:

Parameters	Streams	Physical stream	Stream 1.	Stream setup
------------	---------	-----------------	-----------	--------------

01.Str. ASZK1	
Stream setup	
Fluid selected	crude oil
Units	Total Flowrate
Volume	m ³ m ³ /h
Mass	t t/h
Energy	GJ GJ/h
Flow meter	liq.turbine meter
Flow signal mode	measured
	3 IO 1 ch.
Check signal	measured
	3 IO 2 ch.
Signal ratio	1
Bad pulse threshold	5 000
Menu	↓ ↑

01.Str. ASZK1	
Stream setup	
Bad pulse threshold	5 000
Good pulse threshold	5 000
Cut off	0.1 %
Eventing	no
Pres. at flow meter	measured
	1 IO 2 ch.
Temp. at flow meter	measured
	2 IO 2 ch.
Pres. at dens.meter	measured
	1 IO 1 ch.
Temp. at dens.meter	measured
	2 IO 1 ch.
Menu	↓ ↑

Ø1.Str. ASZK1		Ø1.Str. ASZK1	
Stream setup		Stream setup	
Temp. at dens.meter	measured	'A' dens.meter sign.	measured
	2 IO 1 ch.	Dens.met.'A' body T	measured
No. of dens. meters	2		2 IO 1 ch.
Primary dens. meter	A	'B' dens.meter sign.	measured
Discrepancy	0.5 kg/m ³		3 IO 4 ch.
'A' dens.meter sign.	measured	Dens.met.'B' body T	measured
	3 IO 3 ch.		2 IO 2 ch.
Dens.met.'A' body T	measured	Stream disabling	no
	2 IO 1 ch.	Batch	no
'B' dens.meter sign.	measured	Meter serial test	disabled
	3 IO 4 ch.	Transm. calibration	no
Dens.met.'B' body T	measured		
Menu	↓ ↑	Menu	↓ ↑

Figure 9-112 Stream setup data page, fluid: crude oil, flow meter: liquid turbine

In this example it is assumed that the flow is measured by turbine meter with dual pulse train.
 The density is measured by two density transmitters at the header pipe.
 The pressure of the fluid is measured at the flow meter and at the density meter.
 The temperature of the fluid is measured at the flow meter and at the density meter.

The data fields on the data page are as follows:

- Fluid selected;
Not editable here, fixed to the fluid selected in the Fluid menu
- Units;
See the available units for volume, mass and energy in Table 9-11.
- Flow meter;
Not editable here, fixed to the flow meter selected in the Flow meter menu
- Flow signal mode;
The mode selected from the list
 - *measured*;
It is assumed that the flow signal is measured on pulse or analog input channel.
The channel number entered here.
- IO *n* Ch *m*;
n – number of I/O board
m – number of channel on the I/O board
 - *modb. sign.* (measured at Modbus channel);
It is assumed that the flow signal is received on Modbus channel. In this case new data entry field appear to enter the flow signal channel parameters.
- Channel *n*;
n – number of Modbus channel;
 - *keypad*;
Keypad flow signal (volume flow rate at line conditions) can be entered here. It serves for testing the flow calculation only.
NOTE
If flow signal is set to keypad the flow rate will be displayed but no totalization will be done.
- Check signal mode;
The mode selected from the list
 - *none*;
 - *measured*;
It is assumed that dual pulse train is received from the turbine meter to check the pulse integrity.
The channel number of the check signal entered here.
- IO *n* Ch *m*;
n – number of I/O board
m – number of channel on the I/O board
- Signal ratio (Main to check signal ratio);
- Bad pulse threshold;
If the difference in the number of pulses received on the main and check pulse input channel higher then this limit then pulse input alarm is raised.
- Good pulse threshold;
If in the pulse input alarm active state the number of pulses received after the pulse input alarm appeared higher then this limit then the pulse input alarm is cleared. However the alarm is logged in the alarm log file.
If the good pulse threshold set to 0 then no automatic clearing of the pulse alarm is done.

- Cut off (Low flow cut off);
Entered in % of the high range of the flow signal input channel.
If the measured flow is below the low flow cut off limit then the flow is assumed to be zero.
- Eventing low flow cut off;
It is operator selectable if the low flow cut off will generate entry in the event log or not.
 - yes;
 - no;
- Pres. at flow meter (Pressure at flow meter mode);
The mode selected from the list (for duplicated pressure signals see 9.2.2.1.3.)
 - measured;
It is assumed that pressure is measured on analog input channel.
The channel number should be entered here.
- IO *n* Ch *m*
n – number of I/O board
m – number of channel on the I/O board
 - modb. sign. (measured at Modbus channel);
It is assumed that pressure signal is received on Modbus channel.
The channel number should be entered here.
- Channel *n*;
n – number of Modbus channel;
 - keypad;
Keypad pressure can be entered here if pressure signal is not available.
- Temp. at flow meter (Temperature at flow meter mode);
The mode selected from the list (for duplicated temperature signals see 9.2.2.1.3.)
 - measured;
It is assumed that temperature is measured on input channel.
The channel number should be entered here.
- IO *n* Ch *m*
n – number of I/O board
m – number of channel on the I/O board
 - modb. sign. (measured at Modbus channel);
It is assumed that temperature signal is received on Modbus channel.
The channel number should be entered here.
- Channel *n*;
n – number of Modbus channel;
 - keypad;
Keypad temperature can be entered here if temperature signal is not available.
- Pres. at dens. meter (Pressure at density meter mode);
The mode selected from the list (for duplicated pressure signals see 9.2.2.1.3.)
 - measured;
It is assumed that pressure is measured on analog input channel.
The channel number should be entered here.
- IO *n* Ch *m*
n – number of I/O board
m – number of channel on the I/O board
 - modb. sign. (measured at Modbus channel);
It is assumed that pressure signal is received on Modbus channel.
The channel number should be entered here.
- Channel *n*;
n – number of Modbus channel;
 - keypad;
Keypad pressure can be entered here if pressure signal is not available.
- Temp at dens. meter (Temperature at density meter mode);
The mode selected from the list (for duplicated temperature signals see 9.2.2.1.3.)
 - measured;
It is assumed that temperature is measured on input channel.
The channel number should be entered here.
- IO *n* Ch *m*
n – number of I/O board
m – number of channel on the I/O board
 - modb. sign. (measured at Modbus channel);
It is assumed that temperature signal is received on Modbus channel.
The channel number should be entered here.

- Channel n ;
 n – number of Modbus channel;
- o keypad;
Keypad temperature can be entered here if temperature signal is not available.
- No. of dens. meters (Number of density transmitters);
Selected from the list
 - o 1 (one);
 - o 2 (two);
The two densitometers are designated as A and B.
- Primary dens. meter (Primary density transmitter);
The density primarily used in the flow calculation selected from the list
 - o A;
 - o B;
 - o average;
- Discrepancy;
The maximum discrepancy between the two densitometer readings entered. Required only if two densitometers selected.
- 'A' dens. meter sign. ("A" density transmitter signal mode);
The mode selected from the list
 - o measured;
It is assumed that density is measured on input channel.
The channel number should be entered here.
- IO n Ch m
 n – number of I/O board
 m – number of channel on the I/O board
 - o modb. sign. (measured at Modbus channel);
It is assumed that density signal is received on Modbus channel.
The channel number should be entered here.
- Channel n ;
 n – number of Modbus channel;
 - o keypad;
Keypad density can be entered here if density signal is not available. Dens.met."A" body T ("A" density transmitter body temperature);
The mode selected from the list
 - o measured;
It is assumed that temperature is measured on input channel.
The channel number should be entered here.
- IO n Ch m
 n – number of I/O board
 m – number of channel on the I/O board
 - o modb. sign. (measured at Modbus channel);
It is assumed that temperature signal is received on Modbus channel.
The channel number should be entered here.
- Channel n ;
 n – number of Modbus channel;
 - o keypad;
Keypad temperature can be entered here if temperature signal is not available.
- 'B' dens. meter sign. ("B" density transmitter signal mode);
The mode selected from the list
 - o measured;
It is assumed that density is measured on input channel.
The channel number should be entered here.
- IO n Ch m
 n – number of I/O board
 m – number of channel on the I/O board
 - o modb. sign. (measured at Modbus channel);
It is assumed that density signal is received on Modbus channel.
The channel number should be entered here.
- Channel n ;
 n – number of Modbus channel;
 - o keypad;
Keypad density can be entered here if density signal is not available.
- Dens.met.'B' body T ('B' density transmitter body temperature);

The mode selected from the list

- o `measured;`
It is assumed that temperature is measured on input channel.
The channel number should be entered here.
 - `IO n Ch m`
n – number of I/O board
m – number of channel on the I/O board
- o `modb. sign.` (measured at Modbus channel);
It is assumed that temperature signal is received on Modbus channel.
The channel number should be entered here.
 - `Channel n,`
n – number of Modbus channel;
- o `keypad;`
Keypad temperature can be entered here if temperature signal is not available.

- Stream disabling;

It is possible to disable the operation of the stream depending on different parameters.

The option is selected from the list:

- o `no;`
Stream never disabled.
- o `input signal;`
Any I/O channel signal can be selected. One lower limit and one upper limit can be selected to disable the stream. The lower limit is selected from `lsc`, `lo`, `lolo` or `none`.
The upper limit is selected from `hsc`, `hi`, `hihi` or `none`
The channel number and the limit causing the stream disabled should be entered here.
 - `IO n Ch m,`
n – number of I/O board
m – number of channel on the I/O board
 - Limit to disable;
Lower limit
 - `lo` (low alarm limit of the I/O channel);
 - `lolo` (low-low alarm limit of the I/O channel);
 - `lsc` (low scale of the I/O channel);
 - `-` (no lower limit will disable the stream);
 Upper limit
 - `hi` (high alarm limit of the I/O channel);
 - `hihi` (high-high alarm limit of the I/O channel);
 - `hsc` (high scale of the I/O channel);
 - `-` (no upper limit will disable the stream);
- o `modbus signal;`
Any Modbus channel signal can be selected. One lower limit and one upper limit can be selected to disable the stream. The lower limit is selected from `lsc`, `lo`, `lolo` or `none`.
The upper limit is selected from `hsc`, `hi`, `hihi` or `none`.
The channel number and the limit causing the stream disabled should be entered here.
 - `Channel n,`
n – number of Modbus channel;
 - Limit to disable;
Lower limit
 - `lo` (low alarm limit of the Modbus channel);
 - `lolo` (low-low alarm limit of the Modbus channel);
 - `lsc` (low scale of the Modbus channel);
 - `-` (no lower limit will disable the stream);
 Upper limit
 - `hi` (high alarm limit of the Modbus channel);
 - `hihi` (high-high alarm limit of the Modbus channel);
 - `hsc` (high scale of the Modbus channel);
 - `-` (no upper limit will disable the stream);
- o `from stream;`
Any stream can be selected.
One lower limit and one upper limit can be selected to disable the stream. The lower limit is selected from `lsc`, `lo`, `lolo` or `none`.
The upper limit is selected from `hsc`, `hi`, `hihi` or `none`.
The stream number and the limit causing the stream disabled should be entered here.

- Stream n ,
 n – serial number of the stream from 1 to 12;
 Limit to disable;
 - Lower limit
 - lo (low alarm limit of the Stream n);
 - lolo (low-low alarm limit of the Stream n);
 - lsc (low scale of the Stream n);
 - - no lower limit will disable the stream);
 - Upper limit
 - hi (high alarm limit of the Stream n);
 - hihh (high-high alarm limit of the Stream n);
 - hsc (high scale of the Stream n);
 - - (no upper limit will disable the stream);

The values of the upper and lower limits are set in the Limits menu of the Stream n being the stream disabling the current stream. The type of flow rate (volume at line or at base conditions, mass or energy flow rate) is selected also in the Limits menu of the Stream n . See 9.2.2.1.5.

- Batch;

Batch measurement is enabled or disabled here.

The option is selected from the list:

- o no;
No batch measurement performed.
- o yes;

Batch measurement is enabled. New data entry lines appear where the parameters of the batch measurement shall be enter.

- Batch start/stop

The batch start/stop method is selected here from the list of options:

- from communication interface;

The batch measurement starts and stops by writing certain Modbus registers. The mapping of the start/stop Modbus registers and also the registers where the measured data can be read from see in 10.5.2.

- start key/required quantity;

The batch measurement starts with pulse (pulse length min. 1 s) applied to the appropriate digital input. The batch measurements stops when the required quantity (mass or volume) passed the meter run. The batch measurement can be stopped in case of emergency applying pulse (pulse length min. 1 s) to the appropriate digital input.

In case of this start/stop method, new data entry lines appear as follows:

- Required quantity

Selected from the list:

- uncorr. volume (required quantity is entered in volume units at line conditions);
- mass (required quantity is entered in mass units);

- Batch quantity

Numeric entry field to enter the required batch quantity.

- Batch start input (digital input channel to start batch measurement)

- IO n Ch m

n – number of I/O board

m – number of channel on the I/O board

- Batch stop input (digital input channel to stop batch measurement in case of emergency)

- IO n Ch m

n – number of I/O board

m – number of channel on the I/O board

- Batch control input (digital output channel set to active state during the batch measurement)

- IO n Ch m

n – number of I/O board

m – number of channel on the I/O board

- daily batch measurement;

The batch measurement starts at the defined hour of day and lasts 24 hours (one day). After one day finished the batch measurement for the next day starts automatically. Batch report generated after each day. By this setting second set of daily counters can be defined, which are independent from the standard daily counters and the start hour of this daily batch is also independent from the general starting hour of the day.

In case of this start/stop method, new data entry lines appear as follows:

- Start hour of daily batch
Numeric entry field to enter the start hour of the daily batch measurement. Valid entries are from 0 to 23.
- Batch type
The type of batch measurement is selected here from the list of options:
 - Tank loading/unloading;
Conventional tank loading batch measurement (see 9.1.7.1).
 - Pipeline product interface;
Different kind of fluids flowing in the same pipeline each after other measured as batches (see 9.1.7.2).
Available only if batch start/stop method is "from communication interface".
In case of Pipeline product interface batch type new data entry line appear:
- Product info
Entering into this entry line new data entry display appears where up to 16 different product type and the corresponding density at base conditions shall be entered. See also in 9.2.2.1.1.5. Liquids.

The name of the stream entered in 9.2.2.1. will be displayed on the batch report as station name. To display the results of the batch measurements, see 9.1.7.

- Meter serial test
Flow meter serial test measurement can be enabled or disabled here.
The option is selected from the list:
 - o disabled;
No flow meter serial test measurement performed.
 - o meter serial test;
Flow meter serial test measurement is enabled.
Serial test can be enabled on Stream 1 only.
Warning message appears:
Proceeding will reset all totals and parameters of stream 8. Proceed?
Selecting yes two new lines appear.
 - Shadow stream 8
In the non-custody transfer flow computer, the measured values and totals are displayed in stream 8.
 - Stream
The option is selected from the list:
 - custody transfer stream (slave);
The stream being set up will perform the custody transfer measurement during the serial test. It will operate in normal way. In the data exchange between the two flow computers taking part in the flow meter serial test this flow computer will be the slave device.
 - non custody transfer stream (master);
The stream being set up will perform non custody transfer measurement during the serial test. It will display and totalize the flow in stream 8 instead of the stream being configured for the particular meter run. In the data exchange between the two flow computers taking part in the flow meter serial test this flow computer will be the master device.
 - o flow computer calibration;
The flow computer calibration is a special subset of the meter serial test.
Selecting this option:
 - the stream 8 will be the shadow stream;
 - Uniflow-200 will be the Master device in the calibration.

See details of the meter serial test measurements and the flow computer calibration in 9.1.8.
- Transmitter calibration
Calibration of the transmitters can be enabled or disabled here. When calibration is enabled for a certain transmitter keypad value shall be entered for the parameter being measured by that transmitter. In this case the flow calculation will be performed with the keypad value of the parameter. The measured value of the input signal is still displayed in the Flow / Plant I/O / IO Board x menu allowing the calibration of the transmitter without interrupting the flow measurement. NOTE: the transmitter calibration shall be disabled after finishing the transmitter calibration to recover the normal operation of the flow computer.
The option is selected from the list:
 - o no;
transmitters operate in normal way.
 - o yes;

transmitters are being calibrated. If the *yes* option is selected 4 new menu item appears allowing selection of the transmitters one by one, namely:

- Flow meter
 - no;
flow meter operates in normal way.
 - yes;
flow meter is being calibrated.
 - Keypad value
keypad value to be used in the calculation during the transmitter calibration shall be entered.
- Pressure
 - no;
pressure transmitter operates in normal way.
 - yes;
pressure transmitter is being calibrated.
 - Keypad value
keypad value to be used in the calculation during the transmitter calibration shall be entered.
- Temperature 1
 - no;
temperature 1 transmitter operates in normal way.
 - yes;
temperature 1 transmitter is being calibrated.
 - Keypad value
keypad value to be used in the calculation during the transmitter calibration shall be entered.
- Temperature 2
 - no;
temperature 2 transmitter operates in normal way.
 - yes;
temperature 2 transmitter is being calibrated.
 - Keypad value
keypad value to be used in the calculation during the transmitter calibration shall be entered.

9.2.2.1.3.5 Stream setup example – fluid: crude oil, flow meter: mass flow meter

Route in the menu tree:

Parameters	Streams	Physical stream	Stream 1.	Stream set up
------------	---------	-----------------	-----------	---------------

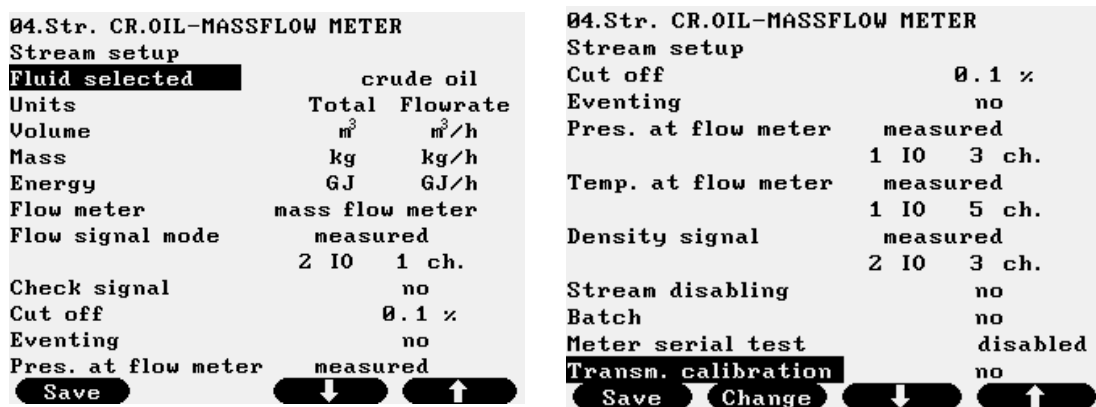

Figure 9-113 Stream setup data page, fluid: crude oil, flow meter: mass flow meter

In this example it is assumed that the flow is measured by mass flow meter.
 The density is measured also by the mass flow meter.
 The pressure and the temperature of the fluid are measured at the flow meter.

The data fields on the data page are as follows:

- Fluid selected;
Not editable here, fixed to the fluid selected in the Fluid menu
- Units;
See the available units for volume, mass and energy in Table 9-11.
- Flow meter;
Not editable here, fixed to the flow meter selected in the Flow meter menu;
- Flow signal mode;
The mode selected from the list
 - *measured*;
It is assumed that the flow signal is measured on pulse or analog input channel.
The channel number entered here.
 - IO *n* Ch *m*;
 - n* – number of I/O board
 - m* – number of channel on the I/O board
 - *modb. sign.* (measured at Modbus channel);
It is assumed that the flow signal is received on Modbus channel. In this case new data entry field appear to enter the flow signal channel parameters.
 - Channel *n*;
 - n* – number of Modbus channel;
 - *keypad*;
Keypad flow signal (mass flow rate) can be entered here. It serves for testing the flow calculation only.
NOTE
If flow signal is set to keypad the flow rate will be displayed but no totalization will be done.
- Cut off (Low flow cut off);
Entered in % of the high range of the flow signal input channel.
If the measured flow is below the low flow cut off limit then the flow is assumed to be zero.
- Eventing low flow cut off;
It is operator selectable if the low flow cut off will generate entry in the event log or not.
 - *yes*;
 - *no*;
- Pres. at flow meter (Pressure at flow meter mode);
The mode selected from the list (for duplicated pressure signals see 9.2.2.1.3.)
 - *measured*;
It is assumed that pressure is measured on analog input channel.
The channel number should be entered here.
 - IO *n* Ch *m*
 - n* – number of I/O board
 - m* – number of channel on the I/O board
 - *modb. sign.* (measured at Modbus channel);
It is assumed that pressure signal is received on Modbus channel.
The channel number should be entered here.
 - Channel *n*;
 - n* – number of Modbus channel;
 - *keypad*;
Keypad pressure can be entered here if pressure signal is not available.
- Temp. at flow meter (Temperature at flow meter mode);
The mode selected from the list (for duplicated temperature signals see 9.2.2.1.3.)
 - *measured*;
It is assumed that temperature is measured on input channel.
The channel number should be entered here.
 - IO *n* Ch *m*
 - n* – number of I/O board
 - m* – number of channel on the I/O board
 - *modb. sign.* (measured at Modbus channel);
It is assumed that temperature signal is received on Modbus channel.
The channel number should be entered here.
 - Channel *n*;
 - n* – number of Modbus channel;
 - *keypad*;
Keypad temperature can be entered here if temperature signal is not available.
- Density signal;
The mode selected from the list

- o `measured;`
It is assumed that density is measured on input channel.
The channel number should be entered here.
 - `IO n Ch m`
 n – number of I/O board
 m – number of channel on the I/O board
- o `modb. sign.` (measured at Modbus channel);
It is assumed that density signal is received on Modbus channel.
The channel number should be entered here.
 - `Channel n,`
 n – number of Modbus channel;
- o `keypad;`
Keypad density can be entered here if density signal is not available.
- **Stream disabling;**
It is possible to disable the operation of the stream depending on different parameters.
The option is selected from the list:
 - o `no;`
Stream never disabled.
 - o `input signal;`
Any I/O channel signal can be selected. One lower limit and one upper limit can be selected to disable the stream. The lower limit is selected from `lsc`, `lo`, `lolo` or `none`.
The upper limit is selected from `hsc`, `hi`, `hihi` or `none`
The channel number and the limit causing the stream disabled should be entered here.
 - `IO n Ch m,`
 n – number of I/O board
 m – number of channel on the I/O board
 - `Limit to disable;`
Lower limit
 - `lo` (low alarm limit of the I/O channel);
 - `lolo` (low-low alarm limit of the I/O channel);
 - `lsc` (low scale of the I/O channel);
 - `-` (no lower limit will disable the stream);
 Upper limit
 - `hi` (high alarm limit of the I/O channel);
 - `hihi` (high-high alarm limit of the I/O channel);
 - `hsc` (high scale of the I/O channel);
 - `-` (no upper limit will disable the stream);
 - o `modbus signal;`
Any Modbus channel signal can be selected. One lower limit and one upper limit can be selected to disable the stream. The lower limit is selected from `lsc`, `lo`, `lolo` or `none`.
The upper limit is selected from `hsc`, `hi`, `hihi` or `none`.
The channel number and the limit causing the stream disabled should be entered here.
 - `Channel n,`
 n – number of Modbus channel;
 - `Limit to disable;`
Lower limit
 - `lo` (low alarm limit of the Modbus channel);
 - `lolo` (low-low alarm limit of the Modbus channel);
 - `lsc` (low scale of the Modbus channel);
 - `-` (no lower limit will disable the stream);
 Upper limit
 - `hi` (high alarm limit of the Modbus channel);
 - `hihi` (high-high alarm limit of the Modbus channel);
 - `hsc` (high scale of the Modbus channel);
 - `-` (no upper limit will disable the stream);
 - o `from stream;`
Any stream can be selected.
One lower limit and one upper limit can be selected to disable the stream. The lower limit is selected from `lsc`, `lo`, `lolo` or `none`.
The upper limit is selected from `hsc`, `hi`, `hihi` or `none`.
The stream number and the limit causing the stream disabled should be entered here.
 - `Stream n,`

n – serial number of the stream from 1 to 12;

Limit to disable;

- Lower limit

- lo (low alarm limit of the Stream n);
- lolo (low-low alarm limit of the Stream n);
- lsc (low scale of the Stream n);
- - no lower limit will disable the stream);

- Upper limit

- hi (high alarm limit of the Stream n);
- hihh (high-high alarm limit of the Stream n);
- hsc (high scale of the Stream n);
- - (no upper limit will disable the stream);

The values of the upper and lower limits are set in the Limits menu of the Stream n being the stream disabling the current stream. The type of flow rate (volume at line or at base conditions, mass or energy flow rate) is selected also in the Limits menu of the Stream n . See 9.2.2.1.5.

- Batch;

Batch measurement is enabled or disabled here.

The option is selected from the list:

- o no;

No batch measurement performed.

- o yes;

Batch measurement is enabled. New data entry lines appear where the parameters of the batch measurement shall be entered.

- Batch start/stop

The batch start/stop method is selected here from the list of options:

- from communication interface;

The batch measurement starts and stops by writing certain Modbus registers. The mapping of the start/stop Modbus registers and also the registers where the measured data can be read from see in 10.5.2.

- start key/required quantity;

The batch measurement starts with pulse (pulse length min. 1 s) applied to the appropriate digital input. The batch measurements stops when the required quantity (mass or volume) passed the meter run. The batch measurement can be stopped in case of emergency applying pulse (pulse length min. 1 s) to the appropriate digital input.

In case of this start/stop method, new data entry lines appear as follows:

- Required quantity

Selected from the list:

- uncorr. volume (required quantity is entered in volume units at line conditions);
- mass (required quantity is entered in mass units);

- Batch quantity

Numeric entry field to enter the required batch quantity.

- Batch start input (digital input channel to start batch measurement)

- IO n Ch m

n – number of I/O board

m – number of channel on the I/O board

- Batch stop input (digital input channel to stop batch measurement in case of emergency)

- IO n Ch m

n – number of I/O board

m – number of channel on the I/O board

- Batch control input (digital output channel set to active state during the batch measurement)

- IO n Ch m

n – number of I/O board

m – number of channel on the I/O board

- daily batch measurement;

The batch measurement starts at the defined hour of day and lasts 24 hours (one day). After one day finished the batch measurement for the next day starts automatically. Batch report generated after each day. By this setting second set of daily counters can be defined, which are independent from the standard daily counters and the start hour of this daily batch is also independent from the general starting hour of the day.

In case of this start/stop method, new data entry lines appear as follows:

- Start hour of daily batch
Numeric entry field to enter the start hour of the daily batch measurement. Valid entries are from 0 to 23.
- Batch type
The type of batch measurement is selected here from the list of options:
 - Tank loading/unloading;
Conventional tank loading batch measurement (see 9.1.7.1).
 - Pipeline product interface;
Different kind of fluids flowing in the same pipeline each after other measured as batches (see 9.1.7.2).
Available only if batch start/stop method is "from communication interface".
In case to Pipeline product interface batch type new data entry line appear:
- Product info
Entering into this entry line new data entry display appears where up to 16 different product type and the corresponding density at base conditions shall be entered. See also in 9.2.2.1.1.5. Liquids.

The name of the stream entered in 9.2.2.1. will be displayed on the batch report as station name. To display the results of the batch measurements see 9.1.7.

- Meter serial test
Flow meter serial test measurement can be enabled or disabled here.
The option is selected from the list::
 - o disabled;
No flow meter serial test measurement performed.
 - o meter serial test;
Flow meter serial test measurement is enabled.
Serial test can be enabled on Stream 1 only.
Warning message appears:
Proceeding will reset all totals and parameters of stream 8. Proceed?
Selecting yes two new lines appear.
 - Shadow stream 8
In the non custody transfer flow computer the measured values and totals are displayed in stream 8.
 - Stream
The option is selected from the list:
 - custody transfer stream (slave);
The stream being set up will perform the custody transfer measurement during the serial test. It will operate in normal way. In the data exchange between the two flow computers taking part in the flow meter serial test this flow computer will be the slave device.
 - non custody transfer stream (master);
The stream being set up will perform non custody transfer measurement during the serial test. It will display and totalize the flow in stream 8 instead of the stream being configured for the particular meter run. In the data exchange between the two flow computers taking part in the flow meter serial test this flow computer will be the master device.
 - o flow computer calibration;
The flow computer calibration is a special subset of the meter serial test.
Selecting this option:
 - the stream 8 will be the shadow stream;
 - Uniflow-200 will be the Master device in the calibration.
- See details of the meter serial test measurements and the flow computer calibration in 9.1.8.

- Transmitter calibration
Calibration of the transmitters can be enabled or disabled here. When calibration is enabled for a certain transmitter keypad value shall be entered for the parameter being measured by that transmitter. In this case the flow calculation will be performed with the keypad value of the parameter. The measured value of the input signal is still displayed in the Flow / Plant I/O / IO Board x menu allowing the calibration of the transmitter without interrupting the flow measurement. NOTE: the transmitter calibration shall be disabled after finishing the transmitter calibration to recover the normal operation of the flow computer.
The option is selected from the list:
 - o no;
transmitters operate in normal way.
 - o yes;
transmitters are being calibrated. If the yes option is selected 4 new menu item appears allowing selection of the transmitters one by one, namely:

- Flow meter
 - no;
flow meter operates in normal way.
 - yes;
 - Keypad value
keypad value to be used in the calculation during the transmitter calibration shall be entered.
- Pressure
 - no;
pressure transmitter operates in normal way.
 - yes;
 - Keypad value
keypad value to be used in the calculation during the transmitter calibration shall be entered.
- Temperature 1
 - no;
temperature 1 transmitter operates in normal way.
 - yes;
 - Keypad value
keypad value to be used in the calculation during the transmitter calibration shall be entered.
- Temperature 2
 - no;
temperature 2 transmitter operates in normal way.
 - yes;
 - Keypad value
keypad value to be used in the calculation during the transmitter calibration shall be entered.

9.2.2.1.3.6 Stream setup example – fluid: electric power, flow meter: electrical power meter

Route in the menu tree:

Parameters	Streams	Physical stream	Stream 1.	Stream set up
------------	---------	-----------------	-----------	---------------

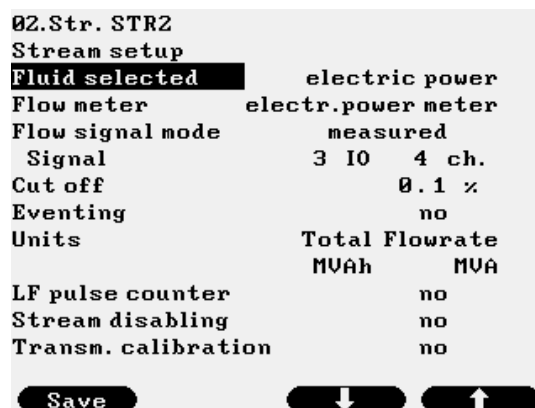

Figure 9-114 Stream setup data page, fluid: electric power, flow meter: electrical power meter

In this example it is assumed that electrical power measurement is required. The flow signal is proportional to the electrical power. In fact, no flow calculation but only the totalization of the flow signal is required.

The data fields on the data page are as follows:

- Fluid selected;
Not editable here, fixed to the fluid selected in the Fluid menu

- Flow meter;
Not editable here, fixed to the flow meter selected in the Flow meter menu
- Units (Total - Flowrate);
Not editable here. The unit of measurement for the Total and Flow rate is taken from the flow signal
 - MVAh - MVA; (in the example)
- Flow signal mode;
The mode selected from the list
 - *measured*;
It is assumed that the flow signal is measured on pulse or analogue input channel.
The channel number entered here.
 - IO *nCh m*;
n - number of I/O board
m - number of channel on the I/O board
 - *modb. sign.* (measured at Modbus channel);
It is assumed that the flow signal is received on Modbus channel. In this case new data entry field appear to enter the flow signal channel parameters.
 - Channel *n*;
n - number of Modbus channel;
 - *keypad*;
Keypad flow signal can be entered here. It serves for testing the flow calculation only.
NOTE
If flow signal is set to keypad the flow rate will be displayed but no totalization will be done.
- Cut off (Low flow cut off);
Entered in % of the high range of the flow signal input channel.
If the measured flow is below the low flow cut off limit then the flow is assumed to be zero.
- Eventing low flow cut off;
It is operator selectable if the low flow cut off will generate entry in the event log or not.
 - *yes*;
 - *no*;
- LF pulse counter;
Not applicable for electric power meter, leave it to "no"
- Stream disabling;
It is possible to disable the operation of the stream depending on different parameters.
The option is selected from the list:
 - *no*;
Stream never disabled.
 - *input signal*;
Any I/O channel signal can be selected. One lower limit and one upper limit can be selected to disable the stream. The lower limit is selected from *lsc*, *lo*, *lolo* or none.
The upper limit is selected from *hsc*, *hi*, *hihi* or none
The channel number and the limit causing the stream disabled should be entered here.
 - IO *n Ch m*;
n - number of I/O board
m - number of channel on the I/O board
 - Limit to disable;
Lower limit
 - *lo* (low alarm limit of the I/O channel);
 - *lolo* (low-low alarm limit of the I/O channel);
 - *lsc* (low scale of the I/O channel);
 - - (no lower limit will disable the stream);
 - Upper limit
 - *hi* (high alarm limit of the I/O channel);
 - *hihi* (high-high alarm limit of the I/O channel);
 - *hsc* (high scale of the I/O channel);
 - - (no upper limit will disable the stream);
 - *modbus signal*;
Any Modbus channel signal can be selected. One lower limit and one upper limit can be selected to disable the stream. The lower limit is selected from *lsc*, *lo*, *lolo* or none.
The upper limit is selected from *hsc*, *hi*, *hihi* or none.
The channel number and the limit causing the stream disabled should be entered here.

- Channel n ,
 n – number of Modbus channel;
 - Limit to disable;
Lower limit
 - lo (low alarm limit of the Modbus channel);
 - lololo (low-low alarm limit of the Modbus channel);
 - lsc (low scale of the Modbus channel);
 - - (no lower limit will disable the stream);
 Upper limit
 - hi (high alarm limit of the Modbus channel);
 - hihi (high-high alarm limit of the Modbus channel);
 - hsc (high scale of the Modbus channel);
 - - (no upper limit will disable the stream);
 - o from stream;
 - Any stream can be selected.
 - One lower limit and one upper limit can be selected to disable the stream. The lower limit is selected from lsc, lo, lololo or none.
 - The upper limit is selected from hsc, hi, hihi or none.
 - The stream number and the limit causing the stream disabled should be entered here.
 - Stream n ,
 n – serial number of the stream from 1 to 12;
 - Limit to disable;
 - Lower limit
 - lo (low alarm limit of the Stream n);
 - lololo (low-low alarm limit of the Stream n);
 - lsc (low scale of the Stream n);
 - - no lower limit will disable the stream);
 - Upper limit
 - hi (high alarm limit of the Stream n);
 - hihi (high-high alarm limit of the Stream n);
 - hsc (high scale of the Stream n);
 - - (no upper limit will disable the stream);
- The values of the upper and lower limits are set in the Limits menu of the Stream n being the stream disabling the current stream. The type of flow rate (volume at line or at base conditions, mass or energy flow rate) is selected also in the Limits menu of the Stream n . See 9.2.2.1.5.

9.2.2.1.4 Premium limits

UNIFLOW-200 is prepared to totalize flow in separate counters if the flow rate higher, then a preset limit. The limits for the flow rates are set on this data page.

The premium limit mode, i.e. if the premium flow is calculated on the instantaneous flow rate or on the hourly totals is set in the Premium limit mode setup menu (see section 9.2.2.3)

Function of the F keys on the Premium limits data pages

↓ select the next field for editing

↑ select the previous field for editing

Change modify the selected data field

OK Confirm the selection

Save save the selected/entered data and returns to the parent menu.

Route in the menu tree:

Parameters	Streams	Physical stream	Stream 1.	Premium limits
------------	---------	-----------------	-----------	----------------

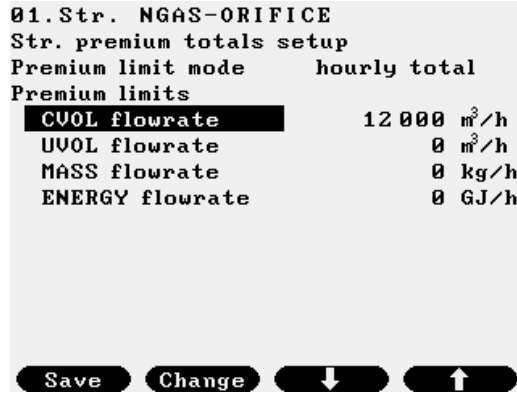

Figure 9-115 Premium limits data page

The data fields on the data page are as follows:

- Premium limit mode;
Not editable here, fixed to the mode selected in the Premium limit mode menu
- CVOL flowrate (volume flow rate at base conditions);
- UVOL flowrate (volume flow rate at line conditions);
- MASS flowrate (mass flow rate);
- ENGY flowrate (energy flow rate);

9.2.2.1.5 Limits

The low-low, lo, high. high-high limits can be set for the stream flow rate.

Function of the F keys on the Limits data pages

↓ select the next field for editing

↑ select the previous field for editing

Change modify the selected data field

OK Confirm the selection

Save save the selected/entered data and returns to the parent menu.

Route in the menu tree:

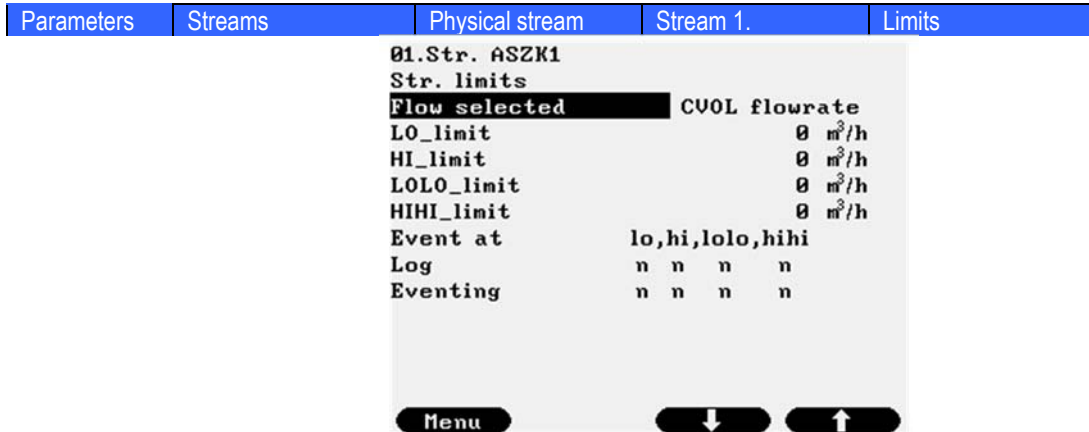

Figure 9-116 Limits data page

The data fields on the data page are as follows:

- Flow selected;
The type flow rate the limit check is applied to is selected here from the list
 - CVOL flowrate (volume flow rate at base conditions);
 - UVOL flowrate (volume flow rate at line conditions);
 - MASS flowrate (mass flow rate);
 - ENGY flowrate (energy flow rate);
 - CO2 mass (CO2 emission flow rate);
- LO limit;

- HI limit;
- LOLO limit;
- HIHI limit;
- Event at

It can be selected here that which of the events shall initiate an entry in the event log file of the flow computer and which of the events shall generate event in the alarm system. The options are:

- o lo (lo limit);
- o hi (hi limit);
- o lololo (lolo limit);
- o hihi (hihi limit);

- Log
- Eventing

Selecting *y* (*yes*) in the “Log” line causes an entry shall be generated in the log file.

Selecting *n* (*no*) in the Log line causes no entry is generated in the log file. In this case no *y* (*yes*) can be selected in the “Eventing” line.

If in the “Log” line *y* (*yes*) is selected, then in the “Eventing” line *y* (*yes*) or *n* (*no*) can be selected, i.e. the operator can decide if the event generates event in the alarm system or not.

9.2.2.2 Virtual stream setup

Virtual streams are designed to perform calculations on the flows determined in the physical streams. Such calculations include for example:

- summing flows of several metering streams to create station totals;
- calculate difference of two flows;
- calculate net efficiency of a boiler;
- calculate pure alcohol flow from the flow of alcohol-water mixture;

First the virtual stream should be selected on the data page shown below.

Stream name can also be entered here.

Route in the menu tree:

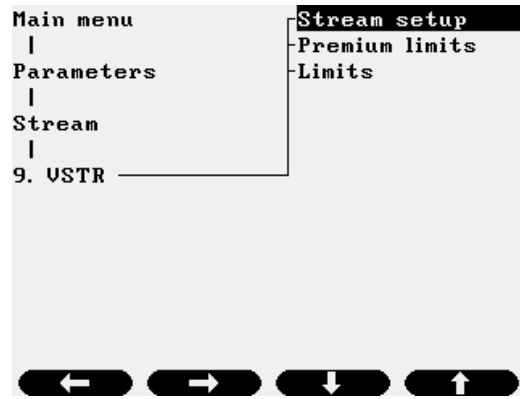
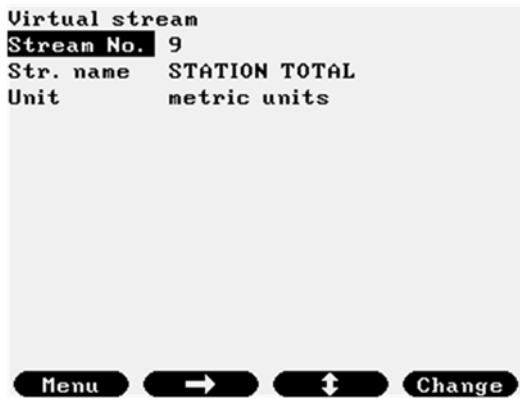

Figure 9-117 Virtual stream selection data page

The system of units shall be selected on this page. Available selections are:

- o metric units;
- o imperial units;

Note:

If the “imperial units” is selected then the unit in all the physical streams flow rate of which processed in this virtual stream shall also be set as “imperial units”. See 9.2.2.1.

If the “imperial units” is selected then the unit of volume, mass and energy are set automatically as follows:

- o volume/volume flow rate MCF MCF/h;
- o mass/mass flow rate lb lb/h;
- o energy/energy flow rate MMBTU MMBTU/h;

and can not be altered.

After selecting the stream to be edited the virtual stream setup data page opens.

9.2.2.2.1 Virtual stream setup

Route in the menu tree:

Parameters	Streams	Virtual streams	Stream 9.	Stream setup
------------	---------	-----------------	-----------	--------------

Function of the F keys on the Virtual stream setup data pages

↓ select the next field for editing

↑ select the previous field for editing

Change modify the selected data field

OK Confirm the selection

Save save the selected/entered data and returns to the parent menu.

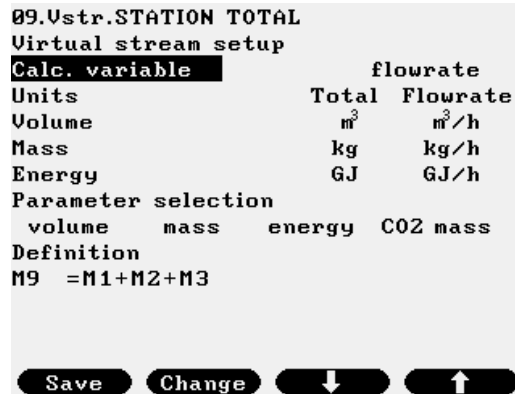

Figure 9-118 Virtual stream setup data page

The data fields on the data page are as follows:

- Calc. variable (Calculated variable);

Selected from the list

- o flow rate;

The virtual stream calculates the flow rates (volume, mass or energy flow rate, depending on the selection in the Parameter selection data field below) according to the equation defined below. The unit of measurement can be selected for the different flow rates.

NOTE

The volume is assumed to be the volume at base conditions.

The selected unit for volume must be the same unit as volume unit in the physical streams processed in virtual stream.

- volume unit (Total – Flowrate);

- m³ – m³/h;

- l – l/h;

- mass unit (Total – Flowrate);

- kg – kg/h;

- t – t/h

- energy unit (Total – Flowrate);

- GJ – GJ/h;

- MJ – MJ/h;

- kWh – kWh/h;

- MWh – MWh/h;

- kVAh – kVA;

- MVAh – MVA;

- Parameter selection;

The parameter to be processed according to the equation defined below should be selected here from the list. One, two, three or all four parameters can be selected.

- volume;

- mass;

- energy;

- CO₂ mass;

- o other param. (other parameter);

If the calculated parameter is not a flow rate but some other parameter then the name of the calculated parameter and its unit can be entered in the data fields below.

- Variable name;
- Unit selection;
 - %;
 - other;
- Input param. selection (Input parameter selection);
The parameter to be processed according to the equation defined below should be selected here from the list.
 - volume;
 - mass;
 - energy;
- Operation (Operation to be performed);
The operation should be selected from the list.
 - integration;
Integration (totalization) can be performed if flow rate is selected as the calculated variable.
 - averaging;
If the calculated variable is not a flow type parameter (for example concentration) then averaging will be performed on the parameter since the integration is not interpreted on the non flow type parameter.
- Equation setup;
The equation describing the calculation to be performed should be entered.

Example 1

Summarize the flow rates from stream 1, 2 and 3

Virtual stream M9 will calculate the sum of flow rates and will totalize the sums into the stream 9 counters.

$$M9 = M1 + M2 + M3$$

Example 2

Calculate the pure alcohol quantity from the flow and from the alcohol concentration measured on stream 1. The pure alcohol is calculated in "100 liters per degree of alcohol" abbreviated as "hldeg".

$$M9 = M1 * MV1 / 100$$

Rules to be followed in the equation setup:

- valid operations: + (summation), - (subtraction), * (multiplication), / (division)
- equation must fit into one line
- first the multiplication and division performed then the summation and subtraction
- operations equal in rank are performed from left to right
- equation must start with number or identifier, it must not be started with operation sign
- virtual stream with lower serial number can only be referenced

Valid identifiers in the equation setup:

- M1 ... M11 flow rate calculated in streams 1 to 11. Depending on the Parameter selection above it can be volume, mass and energy flow rate.
- MV1 ... MV8 concentration (measured or calculated) in streams 1 ... 8 in % (volume)
- MM1 ... MM8 concentration (measured or calculated) in streams 1 ... 8 in % (mass)

9.2.2.2.2 Virtual stream Premium limits

UNIFLOW-200 is prepared to totalize flow in separate counters if the flow rate higher, then a preset limit. The limits for the flow rates are set on this data page.

The premium limit mode, i.e. if the premium flow is calculated on the instantaneous flow rate or on the hourly totals is set in the Premium limit setup menu (see section 9.2.2.3)

Route in the menu tree:

Parameters	Streams	Virtual streams	Stream 9.	Premium limits
------------	---------	-----------------	-----------	----------------

Function of the F keys on the virtual stream premium limits data pages

⇩ select the next field for editing

⇩ select the previous field for editing

Change modify the selected data field

OK Confirm the selection

Save save the selected/entered data and returns to the parent menu.

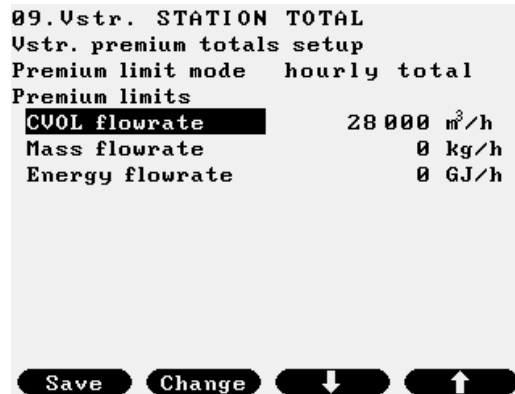

Figure 9-119 Virtual stream premium limits data page

The data fields on the data page are as follows:

- Premium limit mode;
Not editable here, fixed to the mode selected in the Premium limit mode menu
- CVOL flowrate (volume flow rate at base conditions);
- MASS flowrate (mass flow rate);
- ENGY flowrate (energy flow rate);

9.2.2.2.3 Virtual stream Limits

LOLO, LO, HI, HIHI limits can be set for the virtual stream flow rate.

Route in the menu tree:



Function of the F keys on the virtual stream limits data pages

↓ select the next field for editing

↑ select the previous field for editing

Change modify the selected data field

OK Confirm the selection

Save save the selected/entered data and returns to the parent menu.

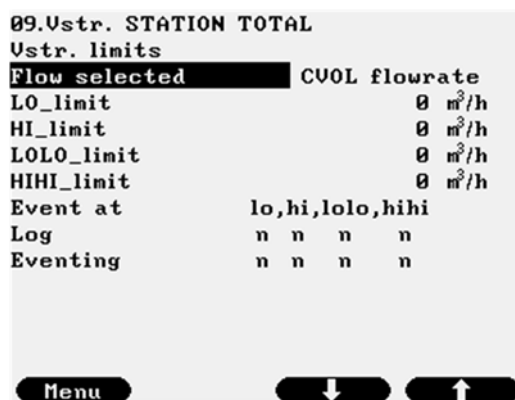

Figure 9-120 Virtual stream limits data page

The data fields on the data page are as follows:

- Flow selected;
The type flow rate the limit check is applied to is selected here from the list
 - CVOL flowrate (volume flow rate at base conditions);
 - MASS flowrate (mass flow rate);
 - ENGY flowrate (energy flow rate);
 - CO2 mass (CO2 emission flow rate);

- LO limit;
- HI limit;
- LOLO limit;
- HIHI limit;
- Event at

It can be selected here that which of the events shall initiate an entry in the event log file of the flow computer and which of the events shall generate event in the alarm system. The options are:

- lo (lo limit);
- hi (hi limit);
- lololo (lolo limit);
- hihi (hihi limit);
- Log
- Eventing

Selecting *y* (*yes*) in the “Log” line causes an entry shall be generated in the log file.

Selecting *n* (*no*) in the Log line causes no entry is generated in the log file. In this case no *y* (*yes*) can be selected in the “Eventing” line.

If in the “Log” line *y* (*yes*) is selected, then in the “Eventing” line *y* (*yes*) or *n* (*no*) can be selected, i.e. the operator can decide if the event generates event in the alarm system or not.

9.2.2.3 Premium mode setup

Route in the menu tree:

Parameters	Streams	Premium mode setup
------------	---------	--------------------

Function of the F keys on the premium mode setup data pages

↓ select the next field for editing

↑ select the previous field for editing

Change modify the selected data field

OK Confirm the selection

Save save the selected/entered data and returns to the parent menu.



Figure 9-121 Premium mode setup data page

The mode for premium flow calculation should be setup.

The premium mode selected here is valid for all streams. No separate mode for separate streams can be selected.

The data fields on the data page are as follows:

- Premium limit mode;
 - Selected from the list
 - hourly total;
 - Premium limits are evaluated at the end of each hour. If the hourly quantity (volume, mass and energy) exceeds the premium limit then the quantity above the limit is added to separate premium total counter.
 - The whole total (including the premium part) is totalized in the cumulative and periodic totals as well.
 - flow rate;
 - hysteresis;
 - timeout

The instantaneous flow rate (volume, mass and energy) is permanently compared to the premium limit. If the flow rate exceeds the premium limit + hysteresis and it exceeds longer then the timeout time, then the flow rate exceeding the premium limit is totalized into separate premium counter. The totalization into the premium counters stops when the flow rate decreases below the premium limit.

Exceeding the premium limit generates an entry in the event log.

The whole total (including the premium part) is totalized in the cumulative and periodic totals as well.

9.2.2.4 Fault mode setup

Route in the menu tree:

Parameters	Streams	Fault mode setup
------------	---------	------------------

Function of the F keys on the fault mode setup data pages

↓ select the next field for editing

↑ select the previous field for editing

Change modify the selected data field

OK Confirm the selection

Save save the selected/entered data and returns to the parent menu.

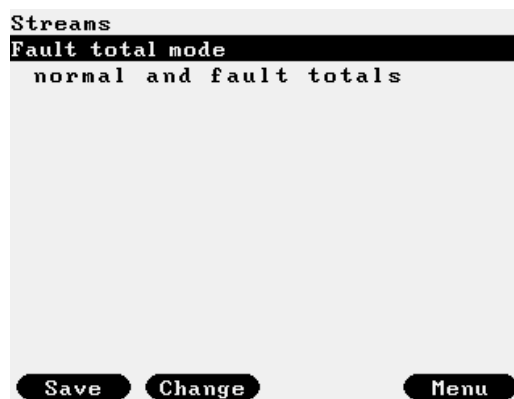

Figure 9-122 Fault mode setup data page

The mode for fault total calculation should be setup.

The fault mode selected here is valid for all streams. No separate mode for separate streams can be selected.

The data fields on the data page are as follows:

- Fault total mode;
 - Selected from the list
 - normal and fault totals;
 - In fault condition the totals are totalized in normal and fault totals.
 - fault totals only;
 - In fault condition the totals are totalized in fault totals only.

The stream considered to be in fault condition if for example:

- input signal fails and the default value of the signal is used in the calculation;
- the difference in the two pulse trains in case of turbine meter exceeds certain limit;
- the beta ratio for the orifice meter is outside the limit described in the standard.

Virtual stream is considered to be in fault condition if any of the streams the data used in the virtual stream calculation from is in fault condition.

See the full list of fault conditions in section 9.3.

9.2.2.5 Barometric pressure

Route in the menu tree:

Parameters	Streams	barometric pressure
------------	---------	---------------------

Function of the F keys on the barometric pressure data pages

↓ select the next field for editing

↑ select the previous field for editing

- Change** modify the selected data field
- OK** Confirm the selection
- Save** save the selected/entered data and returns to the parent menu.

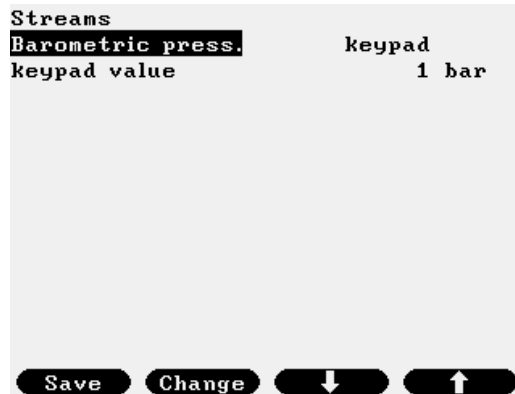

Figure 9-123 Barometric pressure data page

In volume at base conditions flow calculation (e.g. in PTZ calculation) the absolute pressure is required. If the transmitter measuring the pressure is gauge pressure transmitter, then UNIFLOW-200 determines the absolute pressure as sum of the measured gauge pressure plus the barometric pressure. It is assumed that the barometric pressure is common for all streams. The mode for the barometric pressure should be setup here.

The mode selected from the list

- o `measured;`

It is assumed that barometric pressure is measured on analog input channel.

The channel number should be entered here.

- IO *nCh m*

n – number of I/O board

m – number of channel on the I/O board

- o `modb. sign. (measured at Modbus channel);`

It is assumed that barometric pressure signal is received on Modbus channel.

The channel number should be entered here.

- Channel *n,*

n – number of Modbus channel;

- o `keypad;`

Keypad barometric pressure can be entered here if barometric pressure signal is not available.

9.2.2.6 Averaging

Route in the menu tree:

Parameters	Streams	Averaging
------------	---------	-----------

Function of the F keys on the Averaging setup data pages

- Change** modify the selected data field
- OK** Confirm the selection
- Save** save the selected/entered data and returns to the parent menu
- Menu** returns to the parent menu

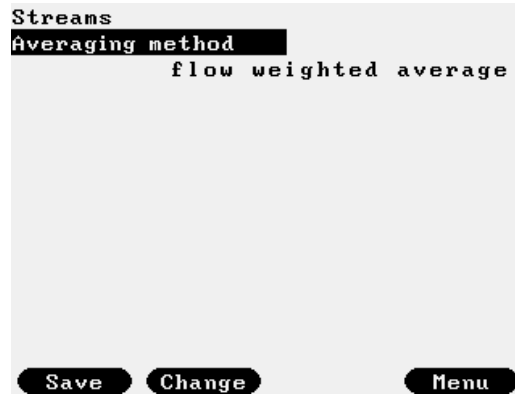

Figure 9-124 Averaging setup data page

The data fields on the data page are as follows:

- Averaging method;
 - arithmetic average;
 - flow weighted average;

In case of arithmetic averaging the value of the parameter to be averaged measured in each calculation cycle will be averaged. In case of flow weighted averaging the value of the parameter to be averaged measured in each calculation cycle will be weighted with the volume at base condition (CVOL) measured in that cycle before the average is calculated.

NOTE

The flow weighted average of a parameter is zero in no flow condition even if the parameter itself is different from zero. Averages are calculated for each time period defined in the flow computer, i.e. hourly, shift, daily, multiday and monthly averages are calculated.

9.2.2.7 Totals format

Route in the menu tree:

Parameters	Streams	Totals format
------------	---------	---------------

Function of the F keys on the Averaging setup data pages

Change modify the selected data field

OK Confirm the selection

Save save the selected/entered data and returns to the parent menu

Menu returns to the parent menu



Figure 9-125 Totals format setup data page

The data fields on the data page are as follows:

- Totals number format;
 - integer;
 - float;

In case of integer selection totals (cumulative, periodic, batch) will be displayed as integer numbers.
 In case of float selection totals (cumulative, periodic, batch) will be displayed as float numbers. The number of decimal places shall also be entered in this case. Valid values are from 1 to 6.

9.2.3 General data

9.2.3.1 Date and time

Route in the menu tree:

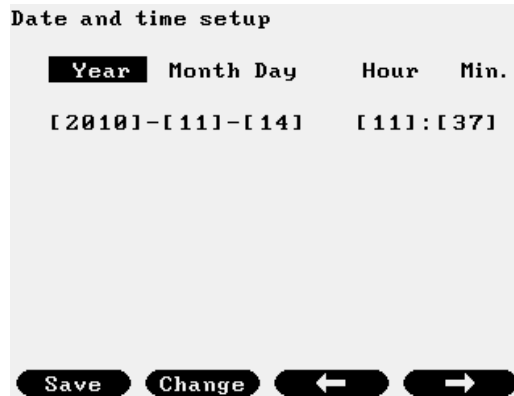

Figure 9-126 Date and time data page

The year, month, day, hour, minute of the real time clock is set here.

9.2.3.2 Timezone

Route in the menu tree:

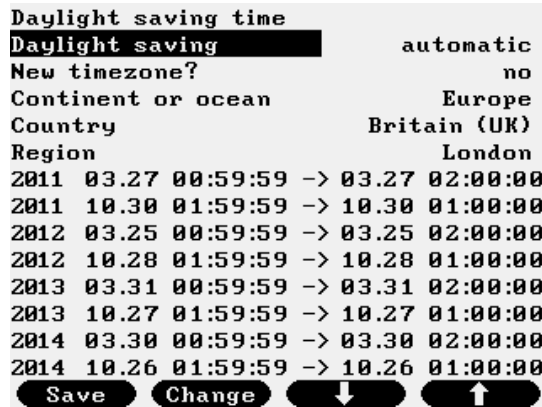

Figure 9-127 Time zone data page

The daylight saving time (DST) rules can be set in this menu item.

The data fields on the data page are as follows:

- Daylight saving;
 - no;
 - No adjustment of the internal clock will be applied to follow the daylight saving time clock adjustment.
 - automatic;
 - Internal clock will adjusted to follow the daylight saving time clock adjustment automatically.
 - If automatic is selected then new menu items appears as follows.
- New timezone;
 - no;
 - Rules of the default location (Europe, Britain (UK), London) will be applied.

- yes
 - New location can be selected corresponding to the time zone of the location of Uniflow-200.
- Continent or ocean
 - Europe;
 - Indian Ocean;
 - Pacific Ocean;
 - Africa;
 - America;
 - Antarctica;
 - Arctic Ocean;
 - Asia;
 - Atlantic Ocean;
 - Australia;
- Country
 - The local country on the selected continent can be selected here from the list
- Region
 - The local region inside the country can be selected here from the list.

9.2.3.3 Periods setting

The length of the time period for which the totalization is done are set here.

Route in the menu tree:



Function of the F keys on the Time periods data pages

↓ select the next field for editing

↑ select the previous field for editing

Change modify the selected data field

OK Confirm the selection

Save save the selected/entered data and returns to the parent menu.

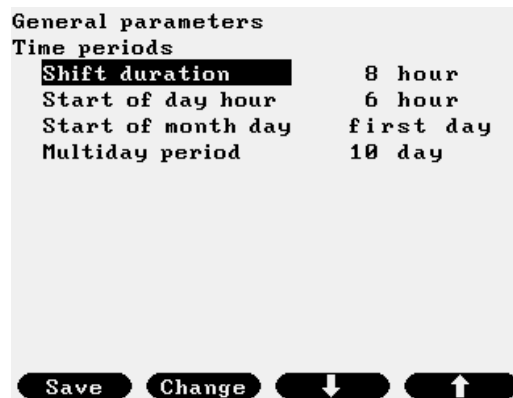

Figure 9-128 Time periods data page

The data fields on the data page are as follows:

- Shift duration;
 - 8 hours;
 - 12 hours;
- Start of day hour;
 - Any hours from 0 to 23
- Start of month day
 - first day;
 - last day;
- Multiday period
 - from 5 to 15 days;

Pressing Save key message appears:

Changing the time period length will erase all the archive data.

Proceed?

If operator selects yes then the new time periods are accepted and archive data are erased.

9.2.3.4 User defined setup

9.2.3.4.1 Display

9.2.3.4.1.1 Summary display setup

Route in the menu tree:

Parameters	General data	User defined	Display page setup	Summary display setup
------------	--------------	--------------	--------------------	-----------------------

Function of the F keys on the Summary display setup data pages

↓ select the next field for editing

↑ select the previous field for editing

⇒ enter the display page for editing

Change modify the selected data field

OK Confirm the selection

Save save the selected/entered data and returns to the parent menu.

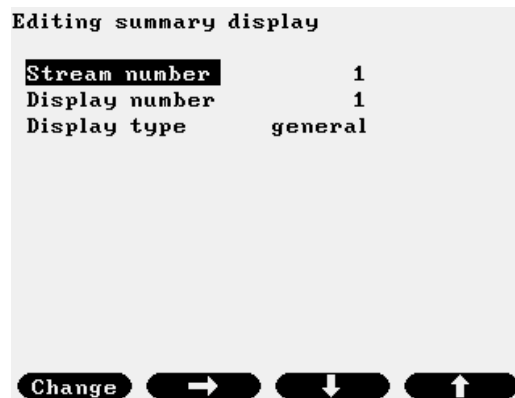

Figure 9-129 Summary display setup data page

The data fields on the data page are as follows:

- Stream number;
 - Separate summary displays defined for each stream.
 - from 1 to 12;
- Display number;
 - 1;
 - 3;
 - 4;
 Display 2 is not editable. It is the large character version of display 1.
- Display type;
 - *general*;
Displays the most important metered and calculated data
 - *prev. month* (previous month);
Displays totals and averages for the previous month.
 - *curr. month* (current month);
Displays totals and averages for the current month.

The default displays for each display type are shown on the figures below.

Function of the F keys on the Display editing data pages

↓ select the next field for editing

⇐ select the previous item to display in the selected line

⇒ select the next item to display in the selected line

OK Confirm the selection

Save save the selected/entered data and returns to the parent menu.

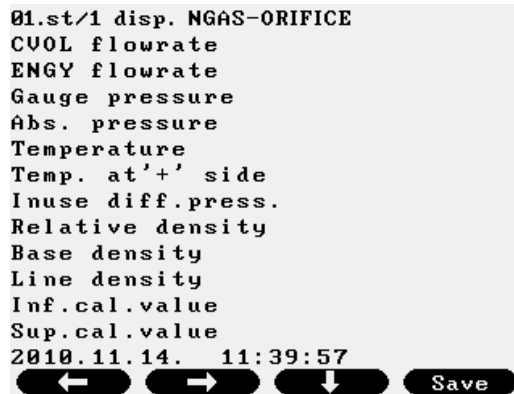

Figure 9-130 Display editing data page, General display

Stream data available for insertion into general display				
Stream data	Physical stream	Virtual stream		
		Flow rate	Other parameter	
			Totalization	Averaging
CVOL flowrate .../h	X	X	-	-
CVOL flowrate .../day	X	X	-	-
UVOL flowrate .../h	X	-	-	-
UVOL flowrate .../day	X	-	-	-
Raw UVOL flowrate .../h	X	-	-	-
Raw UVOL flowrate .../day	X	-	-	-
MASS flowrate .../h	X	X	-	-
MASS flowrate .../day	X	X	-	-
ENGY flowrate .../h	X	X	-	-
ENGY flowrate .../day	X	X	-	-
CVOL	X	X	-	-
UVOL	X	-	-	-
Raw UVOL	X	-	-	-
MASS	X	X	-	-
ENERGY	X	X	-	-
Fault CVOL	X	X	-	-
Fault UVOL	X	-	-	-
Fault Raw UVOL	X	-	-	-
Fault MASS	X	X	-	-
Fault ENERGY	X	X	-	-
Premium CVOL	X	X	-	-
Premium UVOL	X	-	-	-
Premium MASS	X	X	-	-
Premium ENERGY	X	X	-	-
Abs. pressure	X	-	-	-
Gauge pressure	X	-	-	-
Temperature	X	-	-	-
Temperature forward	X	-	-	-
Temperature return	X	-	-	-
Ambient temperature	X	-	-	-
Temperature @ "+" side	X	-	-	-
Line density	X	-	-	-
Base density	X	-	-	-
Relative density	X	-	-	-
Inferior calorific value	X	-	-	-
Superior calorific value	X	-	-	-

CO2	X	-	-	-
N2	X	-	-	-
H2O	X	-	-	-
Inuse diff. pressure	X	-	-	-
Diff. pressure Hi	X	-	-	-
Diff pressure Mid	X	-	-	-
Diff pressure Lo	X	-	-	-
Current day CVOL	X	X	-	-
Previous day CVOL	X	X	-	-
Current month CVOL	X	X	-	-
Previous month CVOL	X	X	-	-
Specific carbon content	X	-	-	-
CO2 emission flowrate .../h	X	X	-	-
CO2 emission flowrate .../day	X	X	-	-
CO2 emission mass	X	X	-	-
Line compression factor	X	-	-	-
Conversion factor	X	-	-	-
Base compression factor	X	-	-	-
Line/Base compression factor	X	-	-	-
Flow time	X	-	-	-
Fault flow time	X	-	-	-
Ethanol %(m/m)	X			
Ethanol %(v/v)	X			
Pressure at density meter	X			
Temperature at density meter	X			
Density meter 1 body temperature	X			
Density meter 2 body temperature	X			
Inuse measured density	X			
Batch MASS	X			
Batch CVOL	X			
Batch UVOL	X			
LF pulse counter	X			
Linear gas velocity	X			
Date and time	X	X	X	X
(Empty line)	X	X	X	X
Calculated variable (in unit/h)	-	-	X	X
Totalized calculated variable (in unit)	-	-	X	-

Table 9-12 Stream data for general summary display

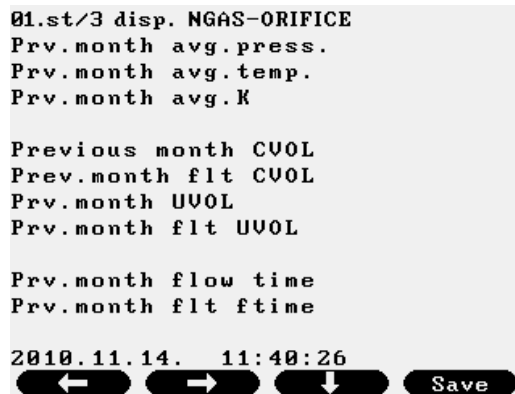

Figure 9-131 Display editing data page, Previous month display

Stream data available for insertion into previous month display

Stream data	Physical stream	Virtual stream		
		Flow rate	Other parameter	
			Totalization	Averaging
Previous month average pressure	X	-	-	-
Previous month average temperature	X	-	-	-
Previous month average K(=Zl/Zb)	X	-	-	-
Previous month CVOL	X	X	-	-
Previous month fault CVOL	X	X	-	-
Previous month UVOL	X	-	-	-
Previous month fault UVOL	X	-	-	-
Previous month max hourly CVOL	X	-	-	-
Previous month max CVOL time	X	-	-	-
Previous month flow time	X	-	-	-
Previous month fault flow time	X	-	-	-
Date and time	X	-	-	-
(empty line)	X	-	-	-

Table 9-13 Stream data for previous month summary display

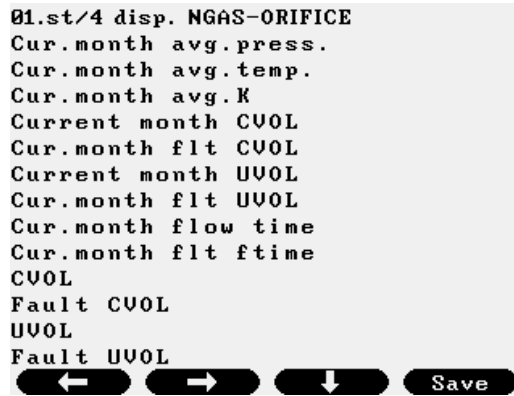

Figure 9-132 Display editing data page, Current month display

Stream data available for insertion into current month display				
Stream data	Physical stream	Virtual stream		
		Flow rate	Other parameter	
			Totalization	Averaging
Current month average pressure	X	-	-	-
Current month average temperature	X	-	-	-
Current month average K(=Zl/Zb)	X	-	-	-
Current hour CVOL	X	-	-	-
Current month CVOL	X	X	-	-
Current month fault CVOL	X	X	-	-
Current hour UVOL	X	-	-	-
Current month UVOL	X	-	-	-
Current month fault UVOL	X	-	-	-
Current month flow time	X	-	-	-
Current month fault flow time	X	-	-	-
CVOL cumulative total	X	-	-	-
Fault CVOL cumulative total	X	-	-	-
UVOL cumulative total	X	-	-	-
Fault UVOL cumulative total	X	-	-	-
Date and time	X	-	-	-
(empty line)	X	-	-	-

Table 9-14 Stream data for current month summary display**9.2.3.4.1.2 Extra summary display setup**

Route in the menu tree:

Parameters	General data	User defined	Display page setup	Extra summary display setup
------------	--------------	--------------	--------------------	-----------------------------

Function of the F keys on the Extra summary display setup data pages

- ↓ select the next field for editing
- ↑ select the previous field for editing
- ⇒ enter the display page for editing

Change modify the selected data field**OK** Confirm the selection**Save** save the selected/entered data and returns to the parent menu.

Str.No.	Item
1	CVOL
2	CVOL
3	CVOL
4	CVOL
5	CVOL
6	CVOL
8	MASS

← → ↓ Save

Figure 9-133 Extra summary display setup data page

The Extra summary display allows group together on single display page data from different streams.

The data fields on the data page are as follows:

- Display number;
 - 1;
 - 2;

After entering the selected display page, the stream number and the data item to be displayed can be selected.

All the data which can be inserted into general display (see Table 9.5.) can be inserted into extra summary display as well.

9.2.3.4.2 Reports

Route in the menu tree:

Parameters	General data	User defined	Reports
------------	--------------	--------------	---------

Function of the F keys on the Reports setup data pages

- ⇒ enter the display page for editing

Change modify the selected data field

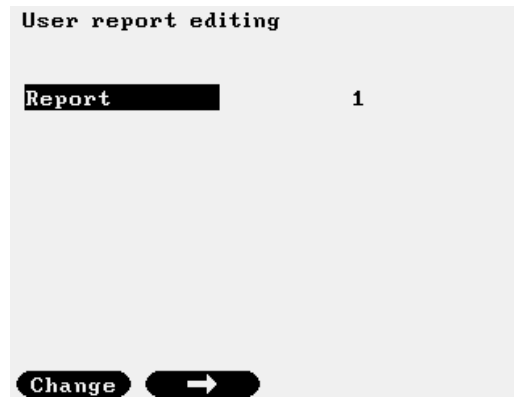

Figure 9-134 User defined report selection data page

There are two types of user defined reports available to report the hourly quantities and averages.

In User report 1 and User report 2 each report consists of 7 data columns. The first column is reserved for the data and time. The data items to be displayed in column 2 to 7 are freely configurable. After selecting the serial number of the report (1 or 2) the setup data page appears.

Function of the F keys on the User report editing data pages

- ↓ select the next field for editing
- ← select the previous item to display in the selected line
- select the next item to display in the selected line
- OK** Confirm the selection
- Save** save the selected/entered data and returns to the parent menu.

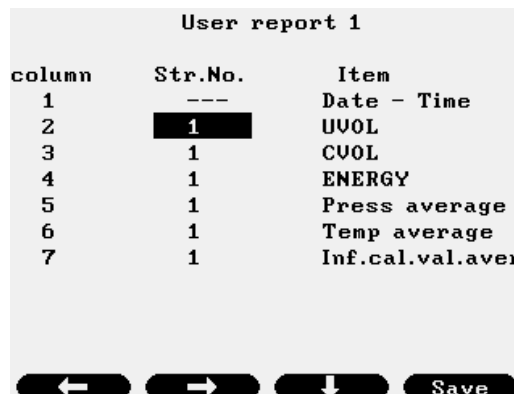

Figure 9-135 User report editing data page for User report 1 and 2

The data fields on the data page are as follows:

- Str.No. (Stream number);
 - from 1 to 12; (Selecting --- (dashes) the column will be left empty.)
- Item;
 - UVOL; (volume at line conditions)
 - CVOL; (volume at base conditions)
 - Mass; (mass)
 - Energy; (energy)
 - CO2 mass; (CO2 emission mass)
 - Fault CVOL; (volume at base conditions at fault condition)
 - Fault Mass; (mass at fault condition)
 - Fault Energy; (energy at fault condition)
 - Fault CO2 mass; (CO2 emission mass at fault condition)
 - Premium CVOL; (premium volume at base conditions)
 - Premium Mass; (premium mass)
 - Premium Energy; (premium energy)
 - Premium CO2 mass; (premium CO2 emission mass)

- o Temp average; (average temperature)
- o Press average; (average pressure)
- o dP average; (average differential pressure)
- o Line dens average; (average line density)
- o K(Zl/Zb) average; (average compressibility ratio)
- o Spec. carb. average; (average specific carbon content)
- o Inf. cal. val. average; (average inferior calorific value)
- o Sup. cal. val. average; (average superior calorific value)
- o Rel. dens. average; (average relative density)
- o Flow time; (flow duration)
- o Fault time; (fault flow duration)

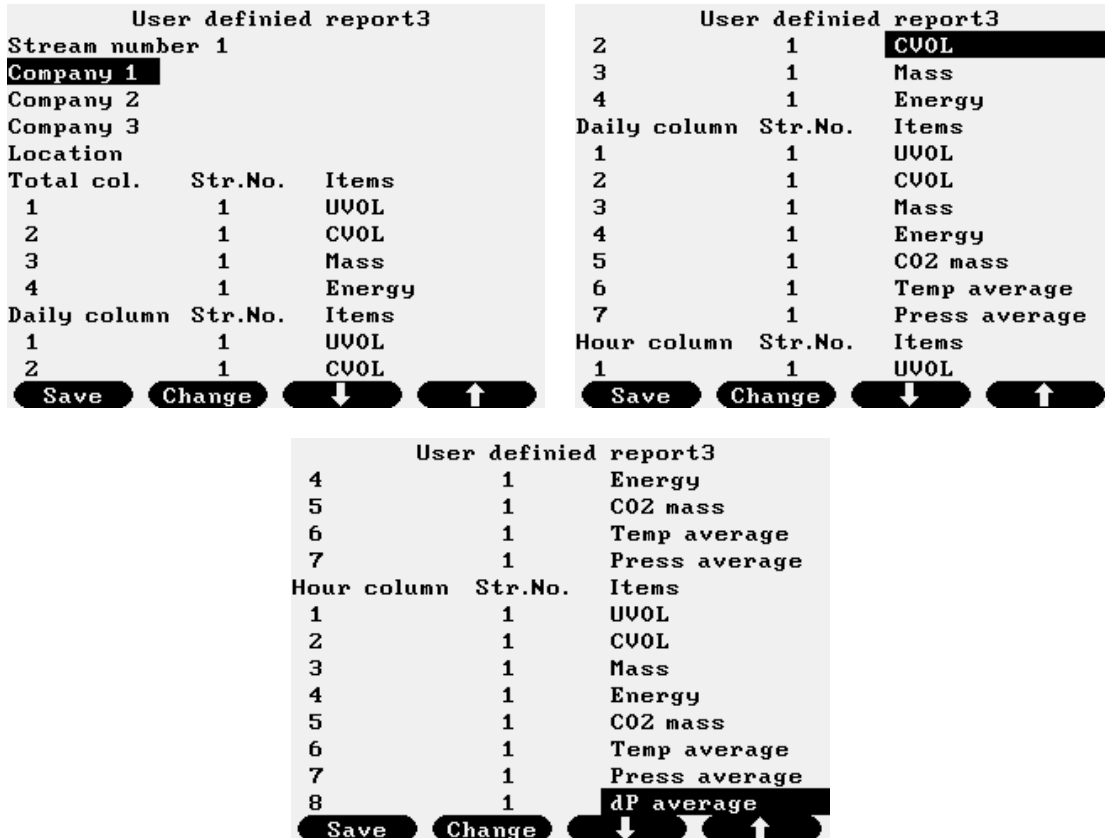

Figure 9-136 User report editing data page for User reports 3 to 10

User report 3 to User report 10 are daily billing reports for streams. Each of the 8 reports can be freely assigned to any stream. See sample of reports in Annex A.

The reports are consist of 5 sections:

- header section;
- totals section;
- daily data section;
- hourly data section;
- footer section.

In the header section general data of the metering stream are indicated.

In the totals section totals are indicated in four columns. The type of totals can be selected from the list as follows:

- o UVOL; (volume at line conditions)
- o CVOL; (volume at base conditions)
- o Mass; (mass)
- o Energy; (energy)
- o CO2 mass; (CO2 emission mass)
- o Fault UVOL; (volume at line conditions at fault condition)
- o Fault CVOL; (volume at base conditions at fault condition)
- o Fault Mass; (mass at fault condition)

- Fault Energy; (energy at fault condition)
- Fault CO2 mass; (CO2 emission mass at fault condition)
- Premium UVOL; (premium volume at line conditions)
- Premium CVOL; (premium volume at base conditions)
- Premium Mass; (premium mass)
- Premium Energy; (premium energy)
- Premium CO2 mass; (premium CO2 emission mass)

The report will indicate the total for the previous day, for the current day and the cumulative total, for the type of total selected.

In the daily data section totals and/or averages are indicated in 7 columns. The type of totals/averages can be selected from the list as follows:

- UVOL; (volume at line conditions)
- CVOL; (volume at base conditions)
- Mass; (mass)
- Energy; (energy)
- CO2 mass; (CO2 emission mass)
- Fault UVOL; (volume at line conditions at fault condition)
- Fault CVOL; (volume at base conditions at fault condition)
- Fault Mass; (mass at fault condition)
- Fault Energy; (energy at fault condition)
- Fault CO2 mass; (CO2 emission mass at fault condition)
- Premium UVOL; (premium volume at line conditions)
- Premium CVOL; (premium volume at base conditions)
- Premium Mass; (premium mass)
- Premium Energy; (premium energy)
- Premium CO2 mass; (premium CO2 emission mass)
- Temp average; (average temperature)
- Press average; (average pressure)
- dP average; (average differential pressure)
- K(Z1/Zb) average; (average compressibility ratio)
- Spec. carb. average; (average specific carbon content)
- Inf. cal. val. average; (average inferior calorific value)
- Sup. cal. val. average; (average superior calorific value)
- Line dens average; (average line density)
- Base dens average; (average base density)
- Rel. dens. average; (average relative density)
- Flow time; (flow duration)
- GC updates; (number of times the gas composition has been updated)
- Fault time; (fault flow duration)

The report will indicate the value of the totals for the previous day, and the minimum, maximum and average values for the non-total parameters.

In the hourly data section totals and/or averages are indicated in 8 columns. The type of totals/averages can be selected from the list as follows:

- UVOL; (volume at line conditions)
- CVOL; (volume at base conditions)
- Mass; (mass)
- Energy; (energy)
- CO2 mass; (CO2 emission mass)
- Fault UVOL; (volume at line conditions at fault condition)
- Fault CVOL; (volume at base conditions at fault condition)
- Fault Mass; (mass at fault condition)
- Fault Energy; (energy at fault condition)
- Fault CO2 mass; (CO2 emission mass at fault condition)
- Premium UVOL; (premium volume at line conditions)
- Premium CVOL; (premium volume at base conditions)
- Premium Mass; (premium mass)
- Premium Energy; (premium energy)
- Premium CO2 mass; (premium CO2 emission mass)

- o Temp average; (average temperature)
- o Press average; (average pressure)
- o dP average; (average differential pressure)
- o K(Z1/Zb) average; (average compressibility ratio)
- o Spec.carb.average; (average specific carbon content)
- o Inf.cal.val.average; (average inferior calorific value)
- o Sup.cal.val.average; (average superior calorific value)
- o Line dens average; (average line density)
- o Base dens average; (average base density)
- o Rel.dens.average; (average relative density)
- o Flow time; (flow duration)
- o GC updates; (number of times the gas composition has been updated)
- o Fault time; (fault flow duration)

The report will indicate the value of the totals for each hour during the previous day, and the average values for the non-total parameters.

In the footer section space for signature and three company names are provided.

9.2.3.4.3 Trends

Reserved for future use

9.2.3.5 Password setup

Route in the menu tree:

Parameters	General data	Password setup
------------	--------------	----------------

Function of the F keys on the Password setup data pages

Change modify the selected data field

OK Confirm the selection

Save save the selected/entered data and returns to the parent menu.

Menu returns to the parent menu

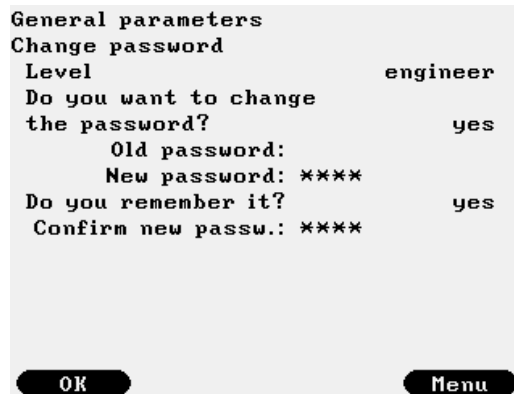

Figure 9-137 Password setup data page

The data fields on the data page are as follows:

- Password level;
 - o operator;
 - o engineer;

The Operator and the Engineer password can be modified here.

Only the Engineer is allowed to modify the password for both levels.

First the old password shall be entered.

Then the new password is entered.

UNIFLOW-200 then requires entering the new password once again.

If the new passwords entered twice are identical then the password is changed.

CAUTION

The flow computer shipped with empty password list. It means that pressing Enter when the flow computer requires password you log in at Engineering level allowing modification all the parameters.

Set your own Operator and Engineering level password to protect the parameters against undesired modification. Remember the password you entered. If you forget your password you will have to ask the assistance of the manufacturer or you have to return the unit to the manufacturer.

9.2.3.6 Reset**9.2.3.6.1 Totals reset**

Route in the menu tree:

Parameters	General data	Reset	Totals	Clear totals Pre-set cumulative totals Pre-set premium totals Pre-set fault totals
------------	--------------	-------	--------	---

Function of the F keys on the Totals reset data pages

Change modify the selected data field

OK Confirm the selection

Save save the selected/entered data and returns to the parent menu.

Menu returns to the parent menu

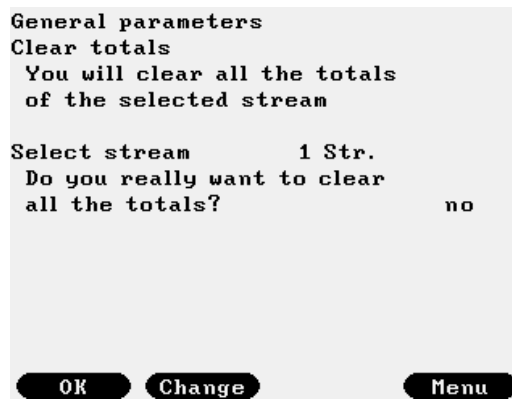

Figure 9-138 Totals reset data page

The Totals reset command clears all the cumulative and periodic totals in the flow computer for the selected streams. Totals reset allowed on Engineer password level only.

The data fields on the data page are as follows:

- Select stream;
 - from 1 to 12;
 - all;

After the stream or all streams are selected UNIFLOW-200 asks to confirm the reset twice. After confirmation all totals are cleared.

Beside clearing the totals in this menu pre-set value of the cumulative totals can be set also. After selecting the kind of the totals (cumulative, fault or premium) data entry page opens. For all the six totals maintained in the flow computer (CVOL, UVOL, Raw UVOL, Mass, Energy, CO2 mass) any starting value of the counter can be entered.

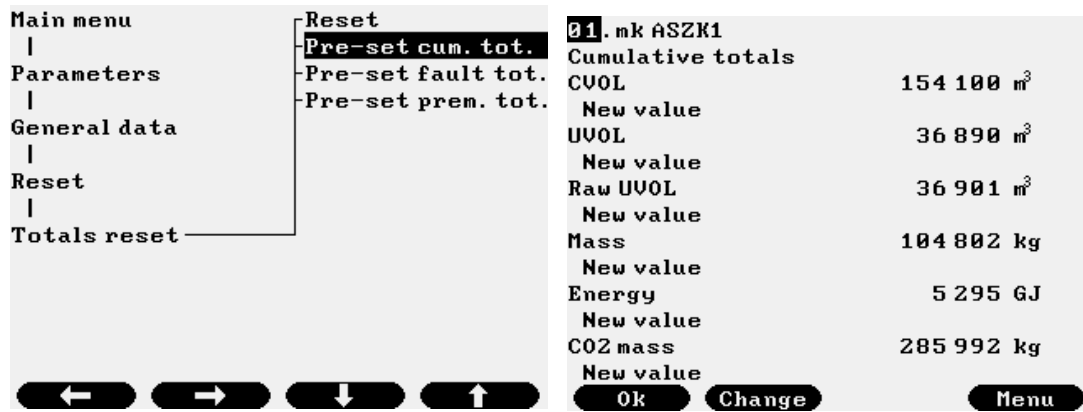

Figure 9-139 Pre-set cumulative totals

Pre-set value allowed to set at no flow condition only, i. e. if flow rates are below the low flow cut-off.
 Totals pre-set allowed on Engineer password level only.
 Pre-set of the cumulative totals only allowed.
 Pre-set on periodic total is not supported.

9.2.3.6.2 General reset

Route in the menu tree:

Parameters	General data	Reset	General reset
------------	--------------	-------	---------------

Function of the F keys on the General reset data pages

Change modify the selected data field

OK Confirm the selection

Save save the selected/entered data and returns to the parent menu.

Menu returns to the parent menu

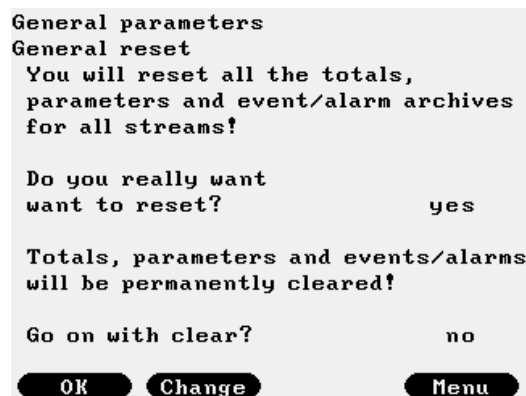

Figure 9-140 General reset data page

The General reset command:

- clears all the cumulative and periodic totals
- clears all the parameters to their default values
- clears the alarm and event log
- sets all I/O signals to inactive
- sets all streams to not defined in the flow computer.

General reset allowed on Engineer password level only.

Apply the general reset with extreme care.

UNIFLOW-200 asks to confirm the general reset twice. After the two confirmations general reset is done.

9.2.3.7 Version control

Data to identify the flow computer hardware and software elements are provided in this menu.

Route in the menu tree:

Parameters	General data	Machine ID
------------	--------------	------------

Function of the F keys on the Version control data pages

Change modify the selected data field

OK Confirm the selection

Save save the selected/entered data and returns to the parent menu.

Menu returns to the parent menu

General parameters	
Machine ID	
Serial no.	200-167
Machine name	UNIFLOW-200 MFC
CPU	120 MHz
Software package	
Op.system	u2_cAL_UX200 v2
Application	u2_cAA_1.1.4.4_130405
PIC	120215
1 pos. ANI4PT2	121217,120222
2 pos. PDI0484	120216,120216
3 pos. AODI0484	120209
4 pos. HTI4x15	120622
5 pos. ANI8	120223,120222
Save	Change
	Menu

Figure 9-141 Version control data page

The data fields on the data page are as follows:

- Serial number;
Not editable
- Machine name;
Any character string can be entered.
The default name is UNIFLOW-200 MFC
Allowed characters: uppercase and lowercase letters, numbers, space, underscore, hyphen
- Operating system version;
Not editable
- Application version;
Not editable
- PIC version;
Not editable
- 1 pos.;
Type of the I/O board fitted into slot 1.
- 2 pos.;
Type of the I/O board fitted into slot 2.
- 3 pos.;
Type of the I/O board fitted into slot 3.
- 4 pos.;
Type of the I/O board fitted into slot 4.
- 5 pos.;
Type of the I/O board fitted into slot 5.

Refer these data if you ask manufacturer assistance.

9.2.3.8 Company data

Route in the menu tree:

Parameters	General data	User data
------------	--------------	-----------

Function of the F keys on the Company data data pages

- ↓ select the next field for editing
- ↑ select the previous field for editing
- Change** modify the selected data field
- OK** Confirm the selection
- Save** save the selected/entered data and returns to the parent menu.

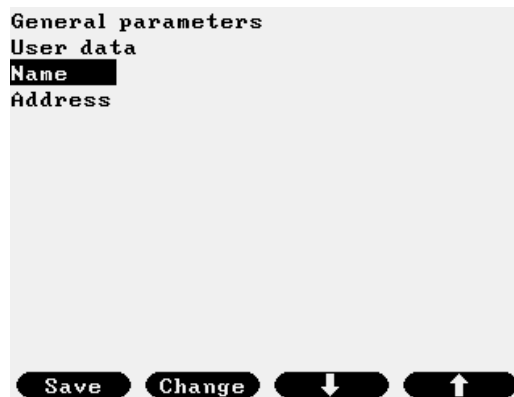

Figure 9-142 User data data page

The data fields on the data page are as follows:

- Name;
 - Any character string can be entered.
 - The default name is empty
 - Allowed characters: uppercase and lowercase letters, numbers, space, underscore, hyphen
- Address;
 - Any character string can be entered.
 - The default address is empty.

9.2.3.9 LCD settings

Route in the menu tree:

Parameters	General data	LCD settings
------------	--------------	--------------

Function of the F keys on the LCD settings data pages

- ↓ decrease the brightness
- ↑ increase the brightness
- ⇕ select the next field for editing
- Change** change the background color
- OK** Confirm the selection
- Save** save the settings and returns to the parent menu.





Figure 9-143 LCD settings data page in different colours

The data fields on the data page are as follows:

- Normal brightness;
Set the required brightness in normal brightness mode from 20 to 100 % in 4 % steps.
- Reduced brightness;
Set the required brightness in reduced brightness mode from 4 to 16 % in 4 % steps.
- Background color;
Set the required background color from the list:
 - blue;
 - black
 - white;

9.2.3.10 Character type

The character type of the display can be selected here. Available selections are:

- Normal font;
- Large font;

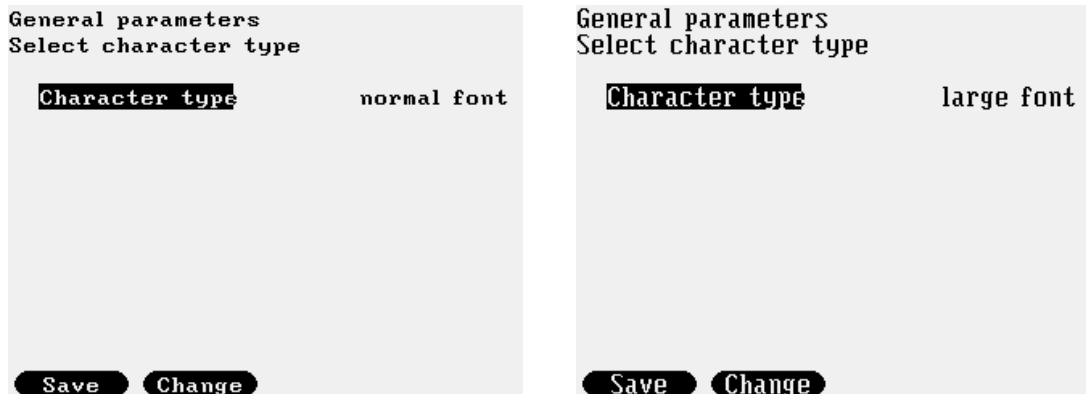

Figure 9-144 Character size selection data page

9.2.4 Interfaces

9.2.4.1 Serial ports

Settings for Com1, Com2, Com3, Com4, Com5, Com6, Com7, Com8 ports are identical.

Com1 port is always available.

Com2 and Com3 ports appear only if SE serial extension module is fitted.

Com4, Com5, Com6, Com7, Com8 ports appear only if CX5 serial extension board is fitted.

Route in the menu tree:

Parameters	General data	Interfaces	Com ports	Com1
------------	--------------	------------	-----------	------

Function of the F keys on the Serial ports data pages

↓ select the next field for editing

↑ select the previous field for editing

Change modify the selected data field

OK Confirm the selection

Save save the selected/entered data and returns to the parent menu.

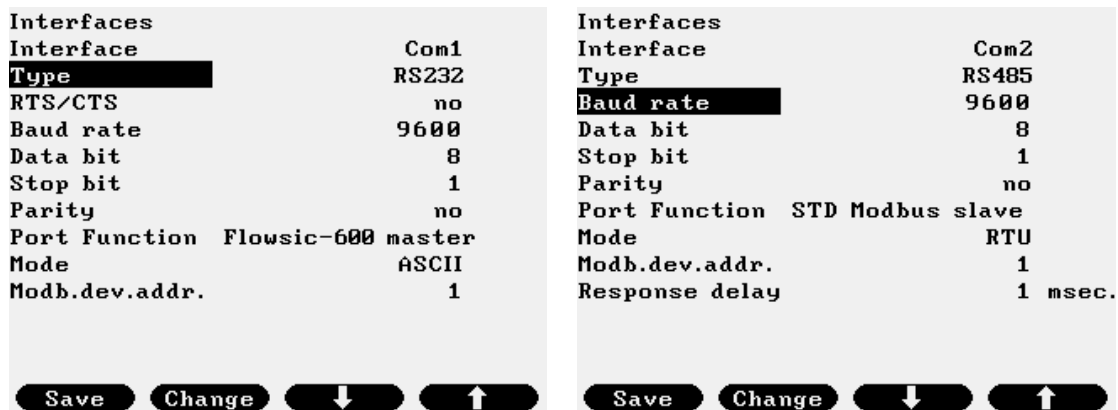

Figure 9-145 Serial ports data page

The data fields on the data page are as follows:

- Type;
 - RS232;
 - RS485;
 - RS422 MD (multidrop);
 - RS422 PP (point to point)
- RTS/CTS (handshake);
 - no;
 - yes;
- Baud rate;
 - 1200;
 - 2400;
 - 4800;
 - 9600;
 - 19200;
 - 38400;
- Data bits;
 - 7;
 - 8;
 - 9;
- Stop bits;
 - 1;
 - 2;
- Parity;
 - none;
 - odd;

- even;
- Port function;
 - STD Modbus slave;

Measured and calculated data can be read from the Uniflow-200 with standard Modbus communication. See details and the Modbus register map in Chapter 10
 - Daniel Modbus slave;

Measured and calculated data can be read from the Uniflow-200 with Daniel/Omni/Enron Modbus communication. See details and the Modbus register map in Chapter 10
 - Ultrasonic meter;

Selecting ultrasonic meter, new entry line appears to select the type of the ultrasonic meter from the list:

 - Caldon US master
 - Daniel US master
 - Flexim US master
 - Flowsic-600 US master
 - Flowsic-600XT US master
 - Krohne US master
 - Panamet US master
 - QSonic US Uniform
 - QSonicPlus US master
 - RMA US master
 - RMG US master
 - Siemens US master
 - FMC MPU Series B

Register address for flow rate data read from US meters is displayed.
UVOL flow rate register addresses fixed to

 - 2700 for Com1
 - 2708 for Com2
 - 2716 for Com3
 - 2724 for Com4
 - 2732 for Com5
 - 2740 for Com6
 - 2748 for Com7
 - 2756 for Com8

Note! In the Modbus signal setup (see 9.2.1.8.) these register addresses must be assigned to the Modbus signal. Modbus mode (RTU or ASCII) and Modbus device address is displayed according to the default settings of the US meter manufacturer.
List of registers read from ultrasonic meter see in 10.7.
 - Chromatograph;

Selecting chromatograph, new entry line appears to select the type of the chromatograph from the list:

 - ABB GC master;
 - ABB2 GC master;
 - Daniel C6+ GC master;
 - Daniel C9+ GC master;
 - Yamatake GC master;
 - Yokogawa GC master;
 - Encal3000 GC master;

Modbus mode (RTU or ASCII) and Modbus device address is displayed according to the default settings of the chromatograph manufacturer.
List of registers read from chromatographs see in 10.7.
In case of Chromatograph function new data entry lines appear as follows:

 - GC number of streams;

Selected from the list:

 - 1 to 4;
 - GC str1 -> Stream

Selected from the list:

 - 1, 2, 3, 4, 5, 6, 7, 8;

Selected the serial number of the flow computer physical streams the stream 1 of the gas chromatograph is assigned to. The gas composition measured on stream 1 of the gas chromatograph will be used in the calculations of these streams.
Any number of stream can be assigned to gas chromatograph stream 1.

- GC str2 -> Stream
Selected from the list:
 - 1, 2, 3, 4, 5, 6, 7, 8;
 Same as for GC stream 1
- GC str3 -> Stream
Selected from the list:
 - 1, 2, 3, 4, 5, 6, 7, 8;
 Same as for GC stream 1
- GC str4 -> Stream
Selected from the list:
 - 1, 2, 3, 4, 5, 6, 7, 8;
 Same as for GC stream 1
- Other;

Selecting other, new entry line appears to select the type of the device to communicate with from the list:

 - Emerson 3095FB MVT;

Additional data entry lines for Emerson 3095FB multivariable transmitter

 - DP differential pressure register address (fixed to 2700 for Com1, 2708 for Com2 and 2716 for Com3);
 - SP static pressure register address (shall be selected from the range 4000 to 4058);
 - PT temperature register address (shall be selected from the range 4000 to 4058);
 - Krohne MFC300 master;

Additional data entry lines for Krohne MFC300 Coriolis flow meter

 - Mass flow rate register address (fixed to 2700 for Com1, 2708 for Com2 and 2716 for Com3);
 - Line density register address (shall be selected from the range 4000 to 4058);
 - Temperature register address (shall be selected from the range 4000 to 4058);
 - UVOL flow rate register address (shall be selected from the range 4000 to 4058);
 - Counter 1 register address (shall be selected from the range 4000 to 4058);
 - Counter 2 register address (shall be selected from the range 4000 to 4058);
 - Micromotion master;

Additional data entry lines for Micromotion Coriolis flow meter

 - Mass flow rate register address (fixed to 2700 for Com1, 2708 for Com2 and 2716 for Com3);
 - Line density register address (shall be selected from the range 4000 to 4058);
 - Temperature register address (shall be selected from the range 4000 to 4058);
 - Pressure register address (shall be selected from the range 4000 to 4058);
 - Meter serial test master;

Used in serial test of the flow meters. See. 9.1.8.
Mode fixed to ASCII.
Number of slaves shall be selected (from 1 to 4 maximum) and Modbus device address for each Slave shall be entered here.
 - Meter serial test slave;

Used in serial test of the flow meters. See. 9.1.8.
Mode fixed to ASCII.
Modbus device address for the Slave shall be entered.
 - FC calibration Master;

Additional data entry lines for FC calibration Master function

 - Data format, available options to select:
 - int32 (long integer number);
 - float32 (single precision floating point number);
 - float64 (double precision floating point number);
 - Byte order, available options to select:
 - 1234;
Example: 123 456 789 = 07 5b cd 15
Example: 123.456 = 42 f6 e9 79
 - 3412;
Example: 123 456 789 = cd 15 07 5b
Example: 123.456 = e9 79 42 f6

- Starting address
Starting address of the counter block in the Slave device shall be entered.
In the next four lines four consecutive addresses are displayed. For each address the counter shall be selected from the list
UVOL (uncorrected volume)
CVOL (corrected volume)
Mass
Energy
E. g. if the starting address 100 and the data format is 32 bit:
100 UVOL (selected from the list UVOL, CVOL, Mass, Energy)
102 CVOL (selected from the list UVOL, CVOL, Mass, Energy)
104 Mass (selected from the list UVOL, CVOL, Mass, Energy)
106 Energy (selected from the list UVOL, CVOL, Mass, Energy)
- Prover slave;
Used in connection with the Prover computer. See uniflow-200 Prover Computer Instruction Manual.
Mode fixed to ASCII.
Modbus device address for the Slave shall be entered.
- Serial printer (CP437 setting is suggested);
Additional data entry lines for the serial printer:
 - Periodic prints (select if periodic printing is required or not)
 - no
No periodic printing will be initiated.
 - daily;
The selected reports will be printed at the end of each day.
 - daily & hourly;
The selected reports will be printed at the end of each day and at the end of each hour.
If daily or daily & hourly is selected then list of reports appears.
It can then be selected for each of them whether print or not to print at the end of period. The reports selectable for printing are as follows:
 - Defined report 1;
 - Defined report 2;
 - Defined report 3;
 - Defined report 4;
 - Defined report 5;
 - Defined report 6;
 - Defined report 7;
 - Defined report 8;
 - Defined report 9;
 - Defined report 10;
 - Cur.day (hourly short);
 - Batch;
- Mode
Selected from the list:
 - RTU;
 - ASCII;
- Modb. dev. addr. (Modbus device address);
Valid addresses from 0 to 256.
- Resp. delay (Response delay) in milliseconds;
Required only if Port type = RS485 or RS422 MD selected.
UNIFLOW-200 will not send response to query within this delay time

9.2.4.2 Ethernet port

Route in the menu tree:

Parameters	General data	Interfaces	Ethernet
------------	--------------	------------	----------

Function of the F keys on the Ethernet port data pages

- ⇓ select the next field for editing
- ⇑ select the previous field for editing

↔ select the next entry field within line

Change modify the selected data field

OK Confirm the selection

Save save the selected/entered data and returns to the parent menu.

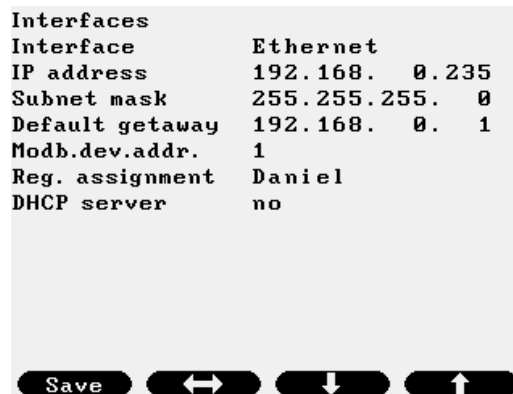

Figure 9-146 Ethernet port data page

The data fields on the data page are as follows:

- IP address;
- Subnet mask;
- Default gateway;
- Modb. dev. addr. (Modbus device address);
Valid addresses from 0 to 256.
- Reg. assignment (Register assignment mode);
Selected from the list:
 - STD Modbus;
Communication on the Ethernet port shall be done with standard Modbus.
See details in Chapter 10.5.
 - Daniel Modbus;
Communication on the Ethernet port shall be done with Daniel/Omni/Enron Modbus.
See details in Chapter 10.6.
- DHCP server;
Selected from the list:
 - enabled;
 - disabled

The factory default settings of the Ethernet port are as follows:

IP address: 192.168.0.100
 Subnet mask: 255.255.255.0
 Default gateway: 192.168.0.1

9.2.4.3 USB

Reserved for future use

9.2.5 Operator parameters

9.2.5.1 Keypad & limits

Data in this menu are allowed to be modified with Operator level password.

Generally the pressure and temperature alarm limits and keypad values belong to this group of parameters.

Route in the menu tree:

Parameters	General data	Operator data	Limits
------------	--------------	---------------	--------

Function of the F keys on the Keypad & limits data pages

- ↓ select the next field for editing
- ↑ select the previous field for editing
- ⇅ select the next stream data for editing

Change modify the selected data field

OK Confirm the selection

Save save the selected/entered data and returns to the stream selection field.

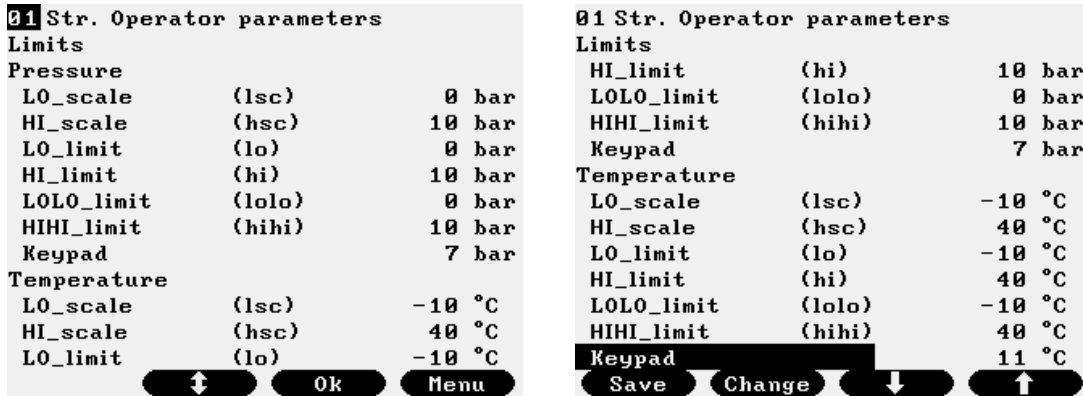

Figure 9-147 Operator data - limits data page

When the data page appears the stream number is highlighted.

Select the stream to be edited pressing ⇅ key. Press OK to confirm the selection. The cursor goes to the first editable field.

After pressing Save the cursor goes to the stream select field.

The data fields on the data page are as follows:

- LO_range;
Signal input low metering range.
Not editable here. Edited in Signals menu at Engineer password level.
- HI_range;
Signal input high metering range.
Not editable here. Edited in Signals menu at Engineer password level.
- LO_limit;
- HI_limit;
- LOLO_limit;
- HIHI_limit;
- Keypad;

9.2.5.2 Keypad values

Data in this menu are allowed to be modified with Operator level password.

Generally the gas composition keypad values belong to this group of parameters.

Route in the menu tree:

Parameters	General data	Operator data	Keypad values
------------	--------------	---------------	---------------

Function of the F keys on the Operator parameters – Keypad values data pages

- ↓ select the next field for editing
- ↑ select the previous field for editing
- ⇅ select the next stream data for editing

Change modify the selected data field

OK Confirm the selection

Save save the selected/entered data and returns to the stream selection field.

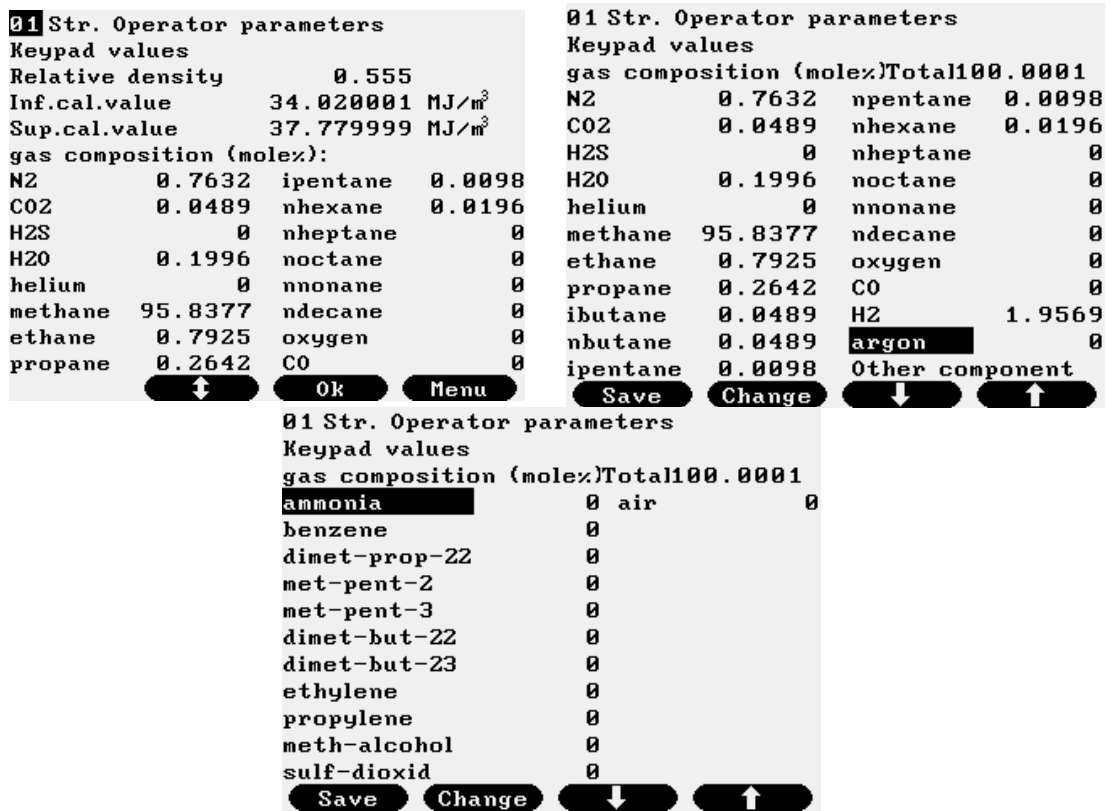

Figure 9-148 Keypad values data page

When the data page appears the stream number is highlighted.

Select the stream to be edited pressing \updownarrow key. Press OK to confirm the selection. The cursor goes to the first editable field.

If no gas composition is available in the stream (e.g. the stream measures liquid) then the data page is empty.

After pressing Save the cursor goes to the stream select field.

The data fields on the data page are as follows:

- Relative density;
- Inferior calorific value;
- Superior calorific value;
- 21 gas components;

The name of the components abbreviated are as follows:

N2	nitrogen
CO2	carbon-dioxide
H2S	hydrogen-sulfide
H2O	water
He	helium
C1	methane
C2	ethane
C3	propane
nC4	n-butane
iC4	i-butane
nC5	n-pentane
iC5	i-pentane
nC6	n-hexane
nC7	n-heptane
nC8	n-octane
nC9	n-nonane
nC10	n-decane
O2	oxygen
CO	carbon-monoxide
H2	hydrogen
Ar	argon

9.2.6 Restore

Route in the menu tree:

Parameters	Restore	Param. project
		Firmware

Function of the F keys on the Restore data pages

Change modify the selected data field

OK Confirm the selection

Save save the selected/entered data and returns to the parent menu.

Menu returns to the parent menu

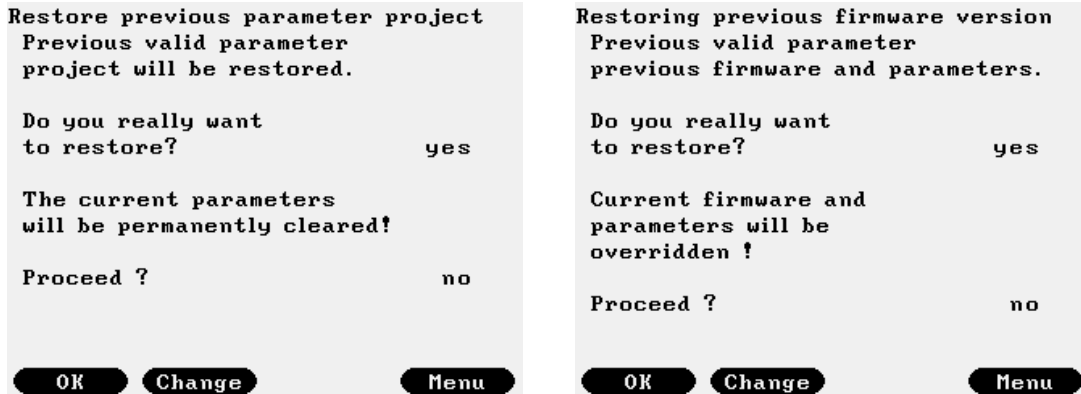

Figure 9-149 Restore data page

In some cases it might be necessary to return to the parameter set or to the firmware being valid before new parameter set or new firmware was downloaded into UNIFLOW-200.

Entering into Restore menu the Parameter project or the Firmware to be restored shall be selected.

Restore is allowed on Engineer password level only.

Apply the Restore with extreme care.

UNIFLOW-200 asks to confirm the Restore twice. After the two confirmations Restore is done.

Be patient. It might take several minutes for Uniflow-200 to finish the restore process.

Never power cycle Uniflow-200 during the restore process. It might make Uniflow-200 unusable and it shall be returned to the manufacturer for repair.

9.2.7 PID Control

9.2.7.1 Operation of the PID control

Uniflow-200 is capable to act as a traditional PID (Proportional Integral Derivative) controller. Maximum of 8 control loops can be configured in each Uniflow-200.

Each control loop can be defined as:

- single loop controller
- dual loop controller for unidirectional flow
- dual loop controller for bidirectional flow

The dual loop controller can be configured to control pressure and flow as follows:

- Pout/max – qmax/q controller
- Pin/min – qmax/q controller

See later the detailed explanation.

9.2.7.1.1 Single loop controller

Block diagram of the single variable control loop is shown on the picture below.

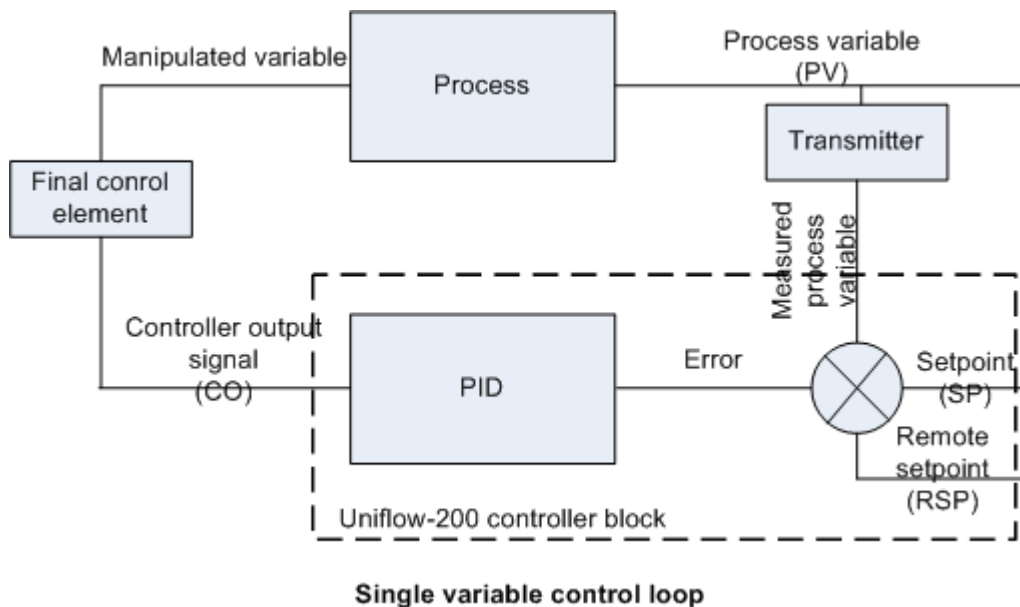

Figure 9-150 Single variable control loop

The purpose of the operation of the PID loop is to keep the process variable (PV) as close as possible to the desired set point (SP) by adjusting the manipulated variable.

The process variable is measured directly by sensor or transmitter or calculated from the measured signal. The control block continuously calculates the difference between the current value of the process variable and the setpoint, i. e. the error. If the error is not zero, then the control block modifies the controller output signal. The modified signal gets to the final control element (which is most of the time a control valve) and modify its position. The final control element modifies generally some fluid or energy flow rate (this is the manipulated variable), which affects the value of the process variable in such a way that it gets closer to the setpoint.

In the controller block of the Uniflow-200 the process variable can be selected as:

- analog input (e. g. pressure);
- any calculated flow rate (volume at line conditions, volume at base conditions, mass or energy) of any metering stream.

The controller output signal is one of the analog output signal of the Uniflow-200.

9.2.7.1.2 Dual loop controller

The dual loop controller block consists of two control loops inside one control block.

One of them is a pressure control loop (PIC) the other is a flow control loop (FIC). Both control loops are permanently in operation and based on their own process variable, setpoint and tuning parameters both of them calculate their own controller output signal.

The two signals go through a signal selection block which passes over the lowest signal to the output of the dual loop control block, i. e. to the analog output channel of Uniflow-200 and finally to the final control element.

The dual control loop block is designed to perform typical for natural gas industry control functions as follows:

- flow control with outlet pressure upper limit control, or, outlet pressure control with flow rate upper limit control ($P_{out}/max - q_{max}/q$);
- flow control with inlet pressure lower limit control, or, inlet pressure control with flow rate upper limit control ($P_{in}/min - q_{max}/q$);

The control function is selected during the set up of the control block.

9.2.7.1.2.1 Dual loop controller with outlet pressure control

Block diagram of the dual loop controller performing flow control with outlet pressure upper limit control, or, outlet pressure control with flow rate upper limit control is shown on the picture below.

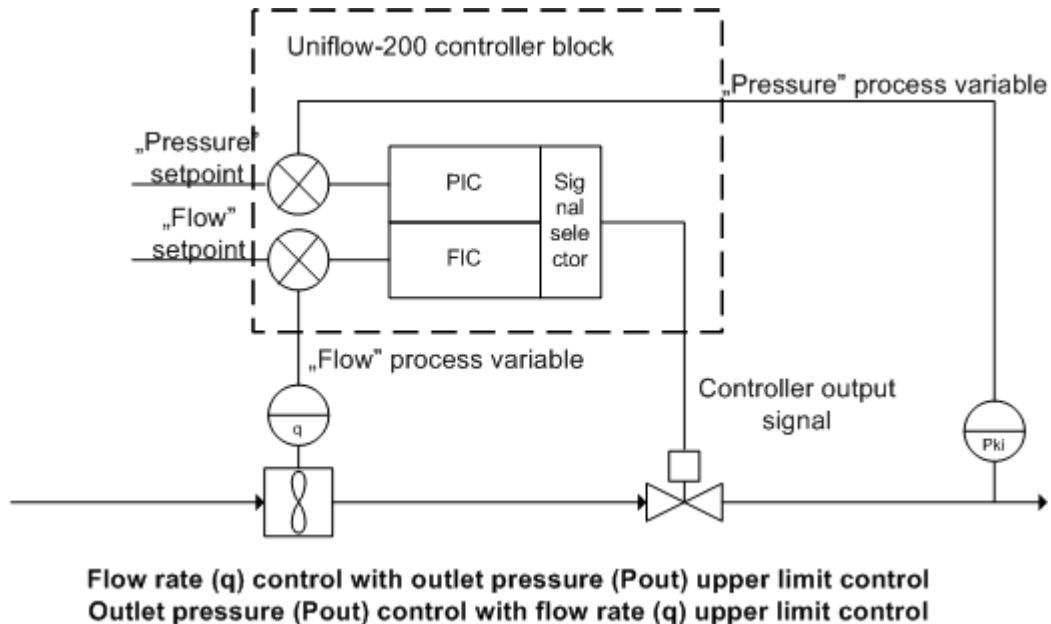

Figure 9-151 Dual loop controller with outlet pressure control

Operation of the control block is explained through a numerical example below.

The control action of the PIC loop is "reverse" in this configuration. Reverse control action means that in case of positive error (error = $PV - SP$, i. e. $PV > SP$, the outlet pressure is higher than the desired outlet pressure) the controller output signal is decreasing (the control valve closes) and in case of negative error ($PV < SP$, the outlet pressure is lower than the desired outlet pressure) increasing (the control valve opens).

The control action of the FIC loop is also "reverse" in this configuration. It means that in case of positive error (error = $PV - SP$, i. e. $PV > SP$, the flow rate is higher than the desired flow rate) the controller output signal is decreasing (the control valve is closing) and in case of negative error ($PV < SP$, the flow rate is lower than the desired flow rate) increasing (the control valve is opening).

Let's have the FIC loop setpoint 20 000 m³/h and the PIC loop setpoint 60 bar.

Let's suppose that the controlled system is in equilibrium which means that the consumers on the pipeline connected to the outlet side of the control valve take off gas quantity from the pipeline equal to the quantity passed through the control valve and fed into the pipeline.

Let's have

- pressure at the inlet side of the control valve: 62 bar
- pressure at the outlet side of the control valve: 58 bar
- output signal of the FIC loop 50 % (this is the lowest from the two output signals so that it gets to the outlet of the control block);
- outlet signal of the PIC loop 100 % (the error = $PV (58 \text{ bar}) - SP (60 \text{ bar})$ is negative, so that because of the reverse control action the output signal reaches 100 % after certain period of time);
- volume flow rate through the control valve at 50 % opening stage 20 000 m³/h.

Let's suppose that consumers at the outlet side reduced the quantity of the gas taken off from the pipeline. As a consequence the pressure increases at the outlet side of the control valve.

With higher outlet pressure the differential pressure across the valve decreases so that the flow rate through the valve decreases. The FIC control loop will have negative error ($= PV - SP$), and having reverse control action it will increase the FIC loop output signal. The FIC control loop is trying to increase the flow rate to achieve setpoint.

As the intake flow higher than the off-take flow after certain period of time the pressure reaches the outlet pressure setpoint at the outlet side of the control valve. At that moment the error in the PIC loop become positive so that, because of the reverse control action the PIC loop decreases its output signal. When the decreasing PIC output signal become lower than the increasing FIC loop output signal the PIC loop takes over the control, the output signal of the control block decreases so that the control valves is closing and the flow rate through the valve is decreasing.

PIC loop keeps the outlet pressure at the desired setpoint while the flow rate will be lower than the flow rate setpoint.

As far as the error in the FIC loop will be negative all the time, the FIC loop output signal reaches 100 % after certain period of time.

If later the quantity of the gas taken off by the consumers increases then the pressure decreases, the error of the PIC loop become negative and the PIC loop increases its output signal (reverse action) and opens the control valve. The flow rate increases then. When the flow rate reaches the FIC loop setpoint the FIC loop error become positive and the FIC loop decreases its output signal (reverse action).

When the decreasing FIC output signal become lower than the increasing PIC loop output signal the FIC loop takes over the control, the output signal of the control block decreases so that the control valves closes and the flow rate through the valve is decreasing.

FIC loop keeps the flow reat at the desired setpoint while the outlet pressure will be lower than the outlet pressure setpoint.

As far as the error in the PIC loop will be negative all the time, the PIC loop output signal reaches 100 % after certain period of time.

The dual loop controller

- controls the flow rate when the flow rate reaches the FIC loop setpoint (the outlet pressure will be below the PIC loop setpoint in this case) and
- controls the outlet pressure when the outlet pressure reaches the PIC loop setpoint (the flow rate will be below the FIC loop setpoint in this case).

9.2.7.1.2.2 Dual loop controller with inlet pressure control

Block diagram of the dual loop controller performing flow control with inlet pressure lower limit control, or, inlet pressure control with flow rate upper limit control is shown on the picture below.

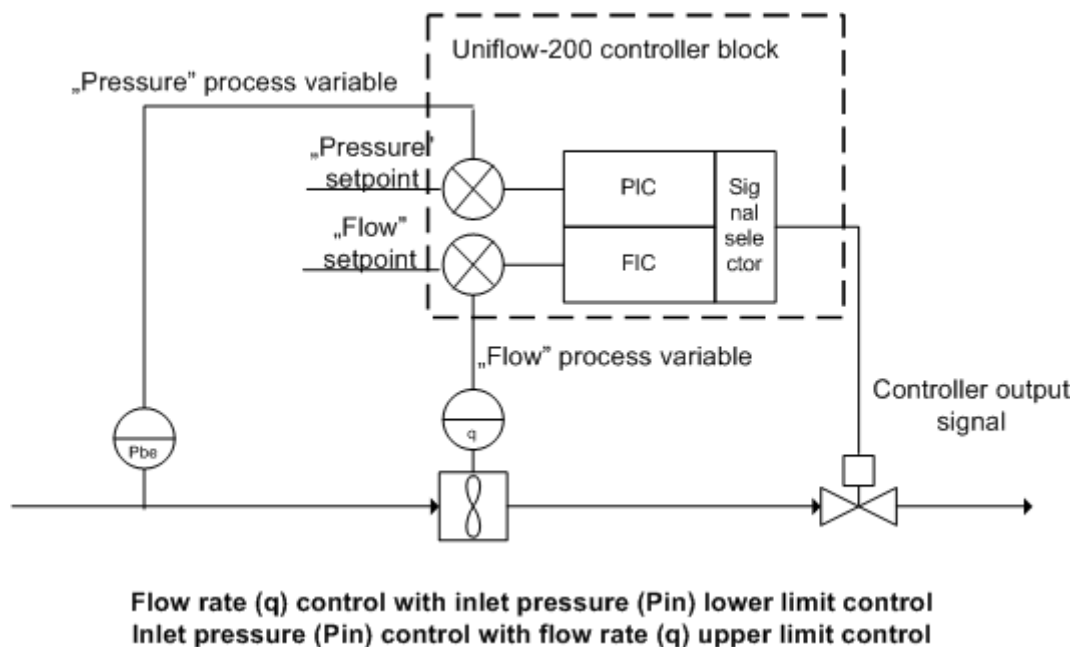

Figure 9-152 Dual loop controller with inlet pressure control

Operation of the control block is explained through a numerical example below.

The control action of the PIC loop is "forward" in this configuration. Forward control action means that in case of positive error (error $= PV - SP$, i. e. $PV > SP$, the inlet pressure is higher then the desired inlet pressure) the controller output signal is increasing (the control valve opens) and in case of negative error ($PV < SP$, the inlet pressure is lower then the desired inlet pressure) decreasing (the control valve closes).

The control action of the FIC loop is “reverse” in this configuration. It means that in case of positive error (error = PV – SP, i. e. PV > SP, the flow rate is higher than the desired flow rate) the controller output signal is decreasing (the control valve closes) and in case of negative error (PV < SP, the flow rate is lower than the desired flow rate) increasing (the control valve opens).

Lets have the FIC loop setpoint 20 000 m³/h and the PIC loop setpoint 60 bar.

Let suppose that the controlled system is in equilibrium which means that the suppliers on the pipeline connected to the inlet side of the control valve put gas quantity into the pipeline equal to the quantity passed through the control valve and taken off from the pipeline.

Lets have

- pressure at the inlet side of the control valve: 62 bar
- pressure at the outlet side of the control valve: 58 bar
- output signal of the FIC loop 50 % (this is the lowest from the two output signals so that it gets to the outlet of the control block);
- outlet signal of the PIC loop 100 % (the error = PV (62 bar) – SP (60 bar) is positive, so that because of the forward control action the output signal reaches 100 % after certain period of time);
- volume flow rate through the control valve at 50 % opening stage 20 000 m³/h.

Let suppose that suppliers at the inlet side reduced the quantity of the gas put into the pipeline. As a consequences the pressure decreases at the inlet side of the control valve.

With lower inlet pressure the differential pressure across the valve decreases so that the flow rate through the valve decreases. The FIC control loop will have negative error (= PV – SP), and having reverse control action it will increase the FIC loop output signal.

The FIC control loop is trying to increase the flow rate to achieve setpoint.

As the intake flow rate lower than the flow rate through the control valve after certain period of time the pressure reaches the inlet pressure setpoint at the inlet side of the control valve. At that moment the error in the PIC loop become negative so that, because of the forward control action the PIC loop decreases its output signal. When the decreasing PIC output signal become lower than the increasing FIC loop output signal the PIC loop takes over the control, the output signal of the control block decreases so that the control valves is closing and the flow rate through the valve is decreasing.

PIC loop keeps the inlet pressure at the desired setpoint while the flow rate will be lower than the flow rate setpoint.

As far as the error in the FIC loop will be negative all the time, the FIC loop output signal reaches 100 % after certain period of time.

If later the quantity of the gas put by the suppliers into the pipeline increases then the pressure increases, the error of the PIC loop become positive and the PIC loop increases its output signal (forward action) and opens the control valve. The flow rate increases then.

When the flow rate reaches the FIC loop setpoint the FIC loop error become positive and the FIC loop decreases its output signal (reverse action).

When the decreasing FIC output signal become lower than the increasing PIC loop output signal the FIC loop takes over the control, the output signal of the control block decreases so that the control valves closes and the flow rate through the valve is decreasing.

FIC loop keeps the flow rate at the desired setpoint while the inlet pressure will be higher than the inlet pressure setpoint.

As far as the error in the PIC loop will be positive all the time, the PIC loop output signal reaches 100 % after certain period of time.

The dual loop controller

- controls the flow rate when the flow rate reaches the FIC loop setpoint (the inlet pressure will be above the PIC loop setpoint in this case) and
- controls the inlet pressure when the inlet pressure reaches the PIC loop setpoint (the flow rate will be below the FIC loop setpoint in this case).

9.2.7.1.2.3 Dual loop controller for bidirectional flow

Block diagram of the dual loop controller for bidirectional flow is shown on the picture below.

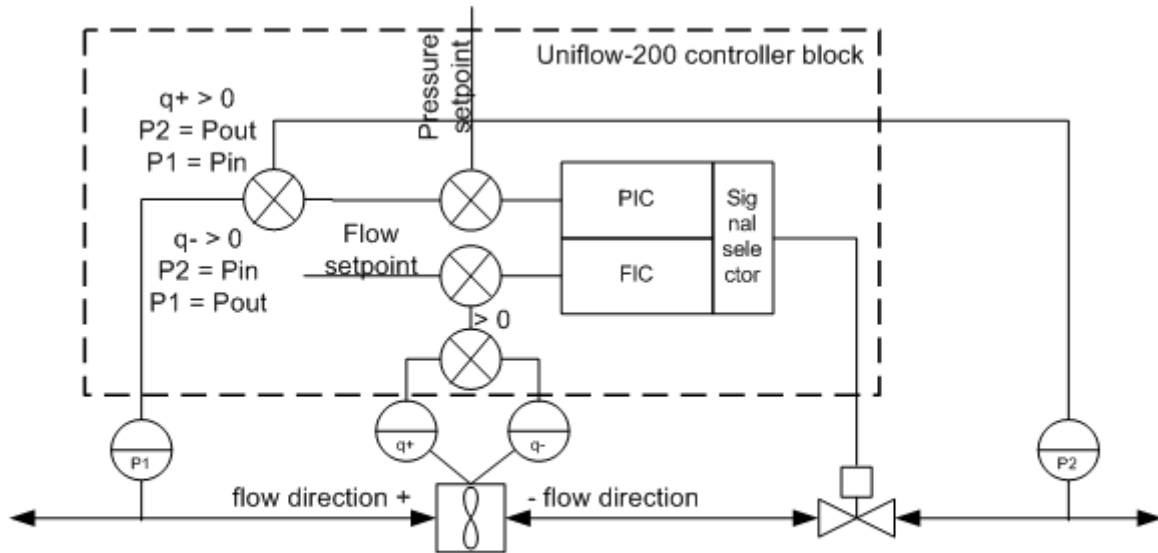

Flow rate control with inlet pressure lower limit control
Flow rate control with outlet pressure upper limit control

Figure 9-153 Dual loop controller for bidirectional flow

In case of bidirectional flow measurement (e. g. with ultrasonic flow meter) Uniflow-200 measures and totalizes the flow in separate metering streams for the positive (+) and negative (-) flow direction.

In the dual loop controller for bidirectional flow the process variable of the FIC loop is automatically selected, depending on the flow direction.

If the outlet pressure is controlled with flow rate control:

- in case of positive flow direction pressure P2 will be the outlet pressure;
- in case of negative flow direction pressure P1 will be the outlet pressure;

If the inlet pressure is controlled with flow rate control:

- in case of positive flow direction pressure P1 will be the inlet pressure;
- in case of negative flow direction pressure P2 will be the inlet pressure;

Depending on the control function to be performed and the flow direction the pressure process variable selected automatically.

Otherwise the controller block works as described in par. 13.6.1.2.1. and 13.6.1.2.2.

9.2.7.2 Calculation algorithm of the controller

Outlet signal of the control loops in the Uniflow-200 is calculated according to the formulas show below.

$$u_k = u_{Pk} + u_{Ik} + u_{Dk}$$

$$u_{Pk} = K_P e_k$$

$$u_{Ik} = u_{Ik-1} + \frac{T K_P}{T_I} e_k$$

$$u_{Dk} = \frac{T_D}{T_D + NT} u_{Dk-1} + \frac{T_D N}{T_D + NT} K_P (e_k - e_{k-1})$$

$$e_k = PV_k - SP_k$$

where:

u – output signal of the control algorithm;

K_P – proportional gain;

T_I – integration time, s;

T_D – derivative time, s;

e – error;
 PV – process variable;
 SP – setpoint;
 N – filter constant (N=10)
 T – calculation cycle time (T = 0.5 s)
 lower indices
 P – proportional term;
 I – integral term;
 D – derivative term;
 k – k-th calculation cycle;
 k-1 – k-1-th calculation cycle ;

9.2.7.3 Set up the PID control

Parameters of the PID control set up can be accessed via menu tree: Main menu / Parameters / PID.

9.2.7.3.1 General set up

Data entry display for the single loop and dual loop controller is shown on the picture below.

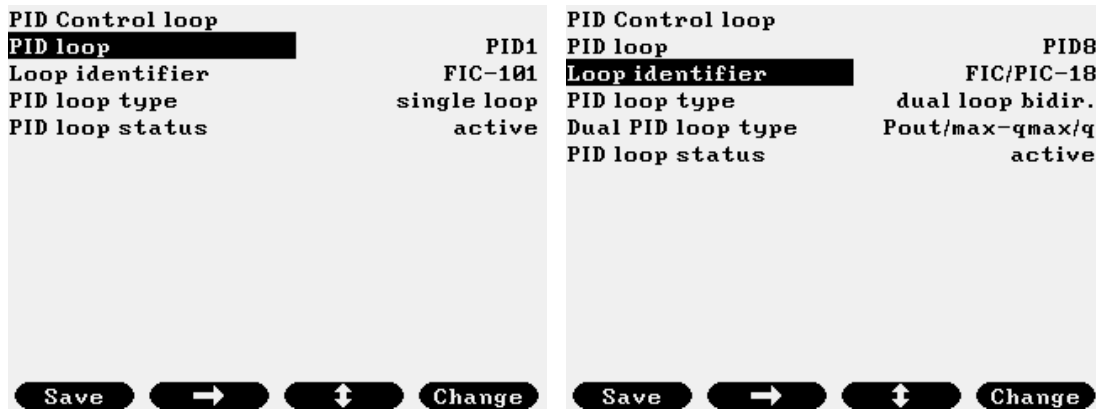

Figure 9-154 PID control loop general setup

Parameters to be set up on this screen are as follows:

- PID loop Identifier of the control loop, selected from list:
 - PID1;
 - PID2;
 - ...;
 - PID8;
- Loop identifier Name of the control loop, any text, e. g. FIC-101
- PID loop type Type of the control loop, selected from list:
 - single loop
 - dual loop unidirectional
 - dual loop bidirectional
- Dual PID loop type (only if dual loop controller)
 Control task, selected from list:
 - Pout/max – qmax/q;
 - Pin/min – qmax/q;
- PID loop status Status of the control loop, selected from list:
 - active;
 - inactive;

After setting up the general parameters pressing key ⇨ leads to the screen for selecting further group of parameters to be set up:

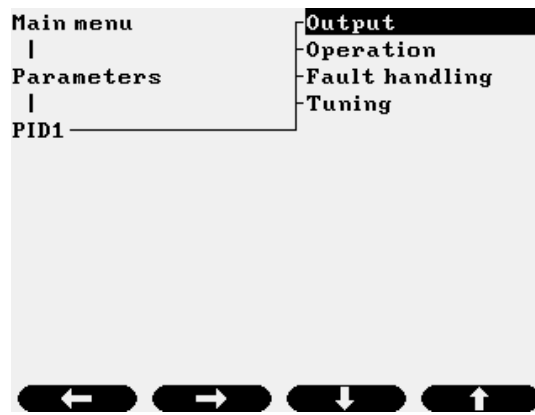

Figure 9-155 PID control loop general setup, parameter group selection

There are separate data entry screens to enter parameters related to:

- output
 - operation
 - fault handling
 - tuning
- of the control loop.

9.2.7.3.2 Output

Output signal is defined and set up on the screen below. Screen is identical for single and dual loop controller.

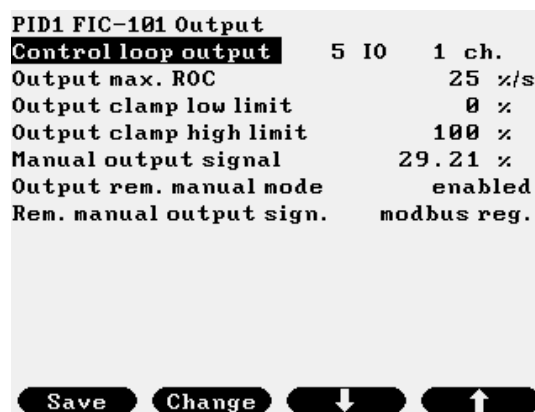

Figure 9-156 PID control loop setup, output

Control loop output X IO. Y ch.	Analog output channel assigned to the control loop output. Only analog output channel of AODIO484 board is a valid selection. The channel should be set up as „PID CO” in the IO board set up menu.
Output max ROC	Maximum rate of change of the output signal in %/s.
Output clamp low limit	Output clamping low limit, output signal never goes below this limit.
Output clamp high limit	Output clamping high limit, output signal never goes above this limit.
Output manual	Output signal value when controller set to manual mode
Output remote manual mode	Enable/disable manipulating output signal in Manual mode via writing Modbus register. Selected from list: - enabled - disabled
Remote manual signal	Source of the remote manual signal. Selected from list: - Modbus reg. (only selection)

The analog output channel of the AODIO484 board assigned to the control loop output should be set up as shown on the picture below. Assignment of the channel shall be set to „PID CO” (PID controller output).

5.IO/1.ch. AODI0484 / A01		5.IO/1.ch. AODI0484 / A01	
Signal name		Assignment	PID CO
Assignment	PID CO	LO_current	4 mA
LO_current	4 mA	HI_current	20 mA
HI_current	20 mA	LO_scale	0 %
LO_scale	0 %	HI_scale	100 %
HI_scale	100 %	LO_limit	0 %
LO_limit	0 %	HI_limit	0 %
HI_limit	0 %	LOLO_limit	0 %
LOLO_limit	0 %	HIHI_limit	0 %
HIHI_limit	0 %	Event at	lsc,hsc,lo,hi,lolo,hihi
Event at	lsc,hsc,lo,hi,lolo,hihi	Log	y y n n n n
Log	y y n n n n	Eventing	y y n n n n
Eventing	y y n n n n	Signal status	active

Figure 9-157 PID control loop setup, analogue output

9.2.7.3.3 Operation

Parameters related to the operation of the control loop shown on the picture below (single loop controller).

PID1 FIC-101 Operation		PID1 FIC-101 Operation	
A/M mode	auto	A/M mode	auto
Setpoint mode	local SP	Setpoint mode	local SP
Setpoint tracking	enabled	Setpoint tracking	enabled
Control action	reverse	Control action	reverse
Process variable mode	input signal	Process variable mode	flow rate
Input signal	2 IO 1 ch.	Stream number	1
Remote setpoint	input signal	Flowrate	CV0L flowrate
Input signal	2 IO 4 ch.	Flow rate URL	1000000 m ³ /h
Local setpoint	20000 m ³ /h	Remote setpoint	modbus
Setpoint max. ROC	5.00 %/s	Local setpoint	20000 m ³ /h
		Setpoint max. ROC	5.00 %/s

Figure 9-158 PID control loop setup, operation, single loop

- A/M mode Auto/Manual mode of the control loop. Selected from list:
 - auto;
 - manual;
- Setpoint mode Setpoint selection. Selected from list:
 - local SP
 - remote SP
- Setpoint tracking Enable/disable setpoint tracking. Selected from list:
 - enabled
 - disabled
 If setpoint tracking is enabled, then:
 - in Manual mode the local setpoint follows the process variable;
 - in Auto mode the manual output value follows the controller output;
 - in Remote setpoint mode the local setpoint follows the remote setpoint.
- Control action Selected from list:
 - forward (in case of positive error (= PV – SP) controller output signal increases, in case of negative error, decreases);
 - reverse (in case of positive error (= PV – SP) controller output signal decreases, in case of negative error, increases);
- Process variable mode Selected from list:
 - measured (IO board, channel);
 - measured X IO Y ch.
 - flow rate (of the selected stream);
 - STR X (stream selected from list from 1 to 12)

- Stream parameter (selected from list)
 - UVOL flow rate;
 - CVOL flow rate;
 - Mass flow rate;
 - Energy flow rate;
- Flow rate upper range limit (numeric entry)
- Remote setpoint mode Selected from list:
 - measured (IO board, channel);
measured X IO Y ch.
 - Modbus register (see Modbus register map in 13.6.4.);
- Setpoint Local setpoint, numeric entry.
- Setpoint max. ROC Maximum rate of change of the setpoint, in %/s. The new local or remote setpoint will reach its final value with this maximum ROC.
For example in case of 1 %/s ROC, entering new setpoint value 80 % instead of old value 40 %, the setpoint will change from 40 % to 80 % in 40 seconds.

Parameters related to the operation of the control loop shown on the picture below (dual loop controller).

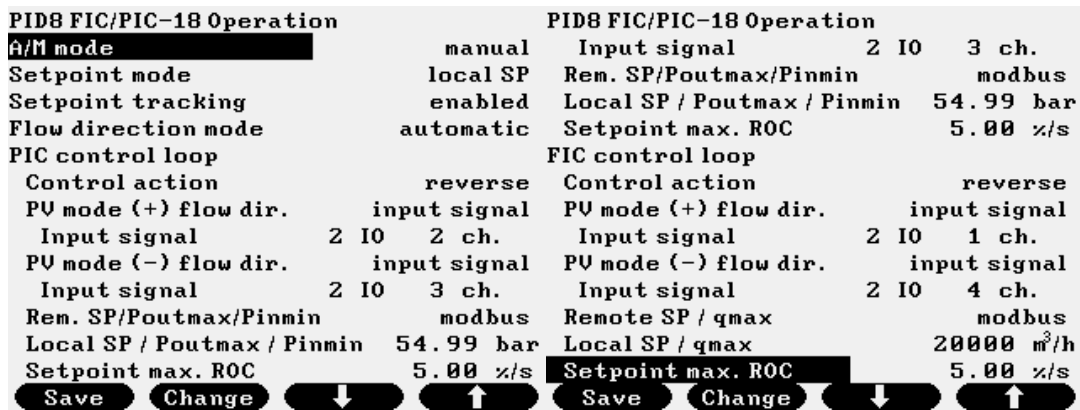

Figure 9-159 PID control loop setup, operation, dual loop

- A/M mode Auto/Manual mode of the control loop. Selected from list:
 - auto;
 - manual;
- Setpoint mode Setpoint selection. Selected from list:
 - local (SP)
 - remote (RSP)
- Setpoint tracking Enable/disable setpoint tracking. Selected from list:
 - enabled
 - disabled

If setpoint tracking is enabled, then:

 - in Manual mode the local setpoint follows the process variable;
 - in Auto mode the manual output value follows the controller output;
 - in Remote setpoint mode the local setpoint follows the remote setpoint.
- Flow direction mode Method of determination of the flow direction (only in dual loop bidirectional controller). Selected from list:
 - automatic (if the volume flow rate >0 in the metering stream for the (+) direction flow then flow direction is considered positive. If the volume flow rate >0 in the metering stream for the (-) direction flow then flow direction is considered negative. If the flow rate = 0 then flow direction is considered as last valid direction);
 - fixed manual (+) direction;
 - fixed manual (-) direction;
 - Modbus register (flow direction is determined by the content of certain Modbus registers. See 13.6.4. for the Modbus map. If register content = 1, positive direction, if register content = 2, negative direction).

PIC loop Control action	Selected from list (not alterable in dual loop controller) - forward (in case of positive error (= PV – SP) controller output signal increases, in case of negative error, decreases) – fixed for inlet pressure control; - reverse (in case of positive error (= PV – SP) controller output signal decreases, in case of negative error, increases) – fixed for outlet pressure control;
PIC loop Process variable mode for (+) flow direction	Selected from list (not alterable) - measured (IO board, channel); measured X IO Y ch.
PIC loop Process variable mode for (-) flow direction	Selected from list (not alterable) - measured (IO board, channel); measured X IO Y ch.
PIC loop Remote setpoint/Poutmax /Pinmin mode	Selected from list: - measured (IO board, channel); measured X IO Y ch. - Modbus register (see Modbus register map in 13.6.4.);
PIC loop Setpoint	Local setpoint, numeric entry.
PIC loop Setpoint max. ROC	Maximum rate of change of the setpoint, in %/s. The new local or remote setpoint will reach its final value with this maximum ROC. For example in case of 1 %/s ROC, entering new setpoint value 80 % instead of old value 40 %, the setpoint will change from 40 % to 80 % in 40 seconds.
FIC loop Control action	Selected from list (not alterable in dual loop controller) - reverse (in case of positive error (= PV – SP) controller output signal decreases, in case of negative error, increases) – fixed for flow rate control;
FIC loop Process variable mode for (+) flow direction	Selected from list: - measured (IO board, channel); measured X IO Y ch. - flow rate (of the selected stream); STR X (stream selected from list from 1 to 12) Stream parameter (selected from list) - UVOL flow rate; - CVOL flow rate; - Mass flow rate; - Energy flow rate; Flow rate upper range limit (numeric entry)
FIC loop Process variable mode for (-) flow direction	Selected from list: - measured (IO board, channel); measured X IO Y ch. - flow rate (of the selected stream); STR X (stream selected from list from 1 to 12) Stream parameter (selected from list) - UVOL flow rate; - CVOL flow rate; - Mass flow rate; - Energy flow rate; Flow rate upper range limit (numeric entry)
FIC loop Remote setpoint/qmax mode	Selected from list: - measured (IO board, channel); measured X IO Y ch. - Modbus register (see Modbus register map in 13.6.4.);
FIC loop Setpoint/qmax	Local setpoint, numeric entry.
FIC loop Setpoint max. ROC	Maximum rate of change of the setpoint, in %/s. The new local or remote setpoint will reach its final value with this maximum ROC. For example in case of 1 %/s ROC, entering new setpoint value 80 % instead of old value 40 %, the setpoint will change from 40 % to 80 % in 40 seconds.

9.2.7.3.4 *Fault handling*

Fault handling is set up on the screen below. Screen is identical for single and dual loop controller.

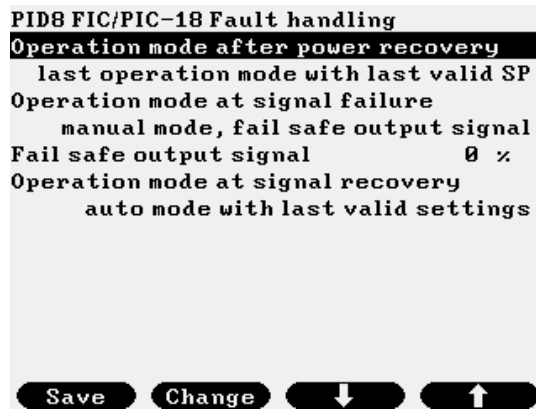

Figure 9-160 PID control loop setup, fault handling

Operation mode after power recovery	Desired operation mode when power recovered after power failure. Selected from list: - manual mode; - last operation mode with local setpoint; - last operation mode with last valid setpoint;
Operation mode at signal failure	Desired operation mode when process variable and/or setpoint signal fails (invalid). Selected from list: - manual mode, last valid output signal; - manual mode, fail safe output signal; Output signal fail safe value in % (numeric entry)
Operation mode at signal recovery	Desired operation mode when failed process variable and/or setpoint signal recovered. Selected from list: - manual mode; - automatic mode with last valid settings;

9.2.7.3.5 *Tuning*

Data entry screens for tuning parameters are shown on the picture below for single loop and dual loop controllers.



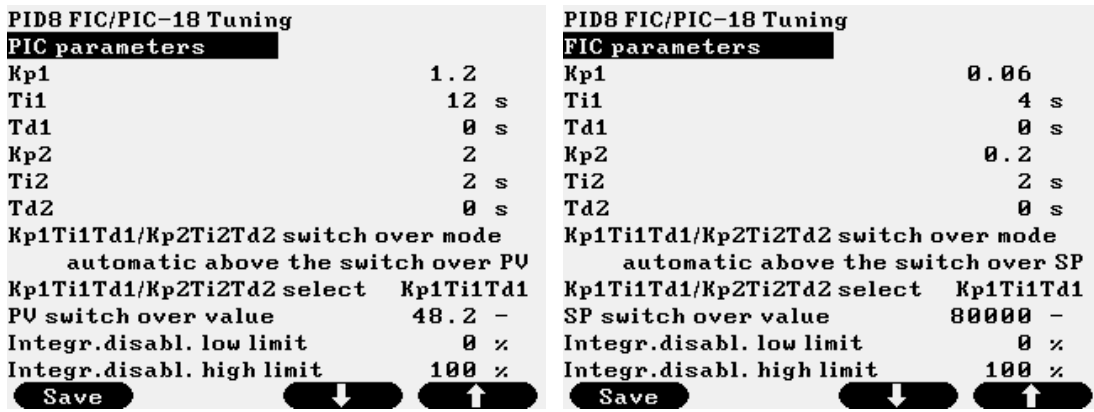

Figure 9-161 PID control loop setup, tuning

For single loop controller tuning parameters are according to table below. For dual loop controller tuning parameters are the same but there are separate set of parameters for FIC loop and PIC loop.

Kp1	Gain in tuning set No.1
Ti1	Integration time in tuning set No.1
Td1	Derivative time in tuning set No.1
Kp2	Gain in tuning set No.2
Ti2	Integration time in tuning set No.2
Td2	Derivative time in tuning set No.2
Kp1Ti1Td1/Kp2Ti2Td2 switch over mode	Switch over mode between tuning set No.1 and No.2. Selected from list: - disabled (no switch over, tuning set No.1 in use); - operator (operator selects the tuning set in use); - automatic above the switch over setpoint (tuning set No.2 selected automatically if setpoint is above the given limit); - automatic above the switch over process variable (tuning set No.2 selected automatically if process variable is above the given limit));
Kp1Ti1Td1/Kp2Ti2Td2 selection	Tuning set. Selected from list: - Kp1Ti1Td1; - Kp2Ti2Td2;
SP/PV switch over value	PV or SV limit for automatic switch over between tuning set No.1 and No.2
Integration term disabling low limit	Integration term is disabled below this limit of the controller output signal, %
Integration term disabling high limit	Integration term is disabled above this limit of the controller output signal, %

9.2.7.4 Operation of the PID control

The screen for operation of the PID control is accessible via path Main menu / Flow / PID as shown on the picture below.

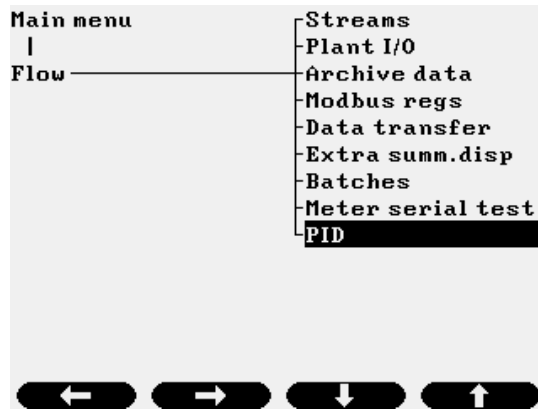

Figure 9-162 Accessing PID control operation screen

After entering into menu select the required PID control loop from PID1 to PID8 by pressing Change button. If inactive PID loop is selected then message shown on the picture below will be displayed.



Figure 9-163 PID control operation, control loop inactive screen

Selecting active PID loop and pressing OK the operational screen of the PID loop is displayed.

9.2.7.4.1 Operation of single loop controller

Operational screen of the single loop controller shown on the picture below.

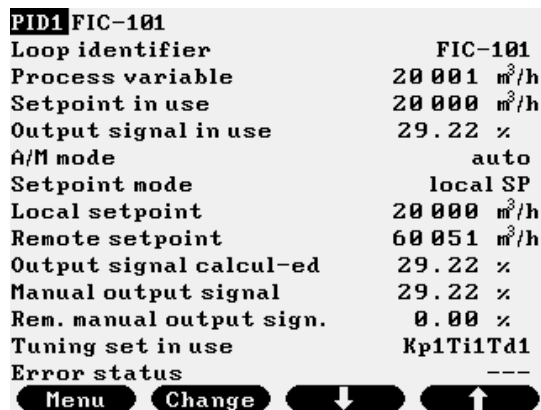

Figure 9-164 PID control operation, single loop controller

Items displayed on the screen are as follows:

- Process variable Current value of the process variable measured on the input channel or calculated in the metering stream.
- Setpoint in use Value of the setpoint used in control (local or remote, depending on the setpoint mode).

Output signal in use	Output signal of the control loop going to the analog output.
A/M mode	Auto/Manual mode of the controller, selected from the list: - auto; - manual
Setpoint mode	Setpoint mode selection. Selected from list: - local (SP) - remote (RSP)
Local setpoint	Entry field for local setpoint. If setpoint mode is set to remote and setpoint tracking is enabled then local setpoint follows the remote setpoint.
Remote setpoint	Indicates the value of the remote setpoint received on input channel or in Modbus register
Output signal calculated	The calculated value of the controller output signal.
Output signal manual	Entry field for the output signal. In manual mode it will be the in use output signal. In auto mode, if setpoint tracking is enabled, it follows the calculated value of the output signal.
Output signal remote manual	Manual value of the output signal written via Modbus register. Valid if output remote manual mode is enabled If the PID loop in manual mode, then output signal can be modified writing the desired output signal value into the dedicated Modbus register. See Modbus register map in 13.6.4. The value written into the Modbus register must differ from the previous value of the register to be transferred to the output.
Tuning set in use	The tuning parameter set currently in use. Selected from list: - Kp1Ti1Td1; - Kp2Ti2Td2.
Error status	Error status of the PID loop. Valid error status: - no error - PV invalid - SP invalid

9.2.7.4.2 Operation of dual loop controller

In case of dual loop controller there are separate operational screen for the FIC loop and PIC loop. After selecting the desired loop (FIC or PIC) and pressing \Rightarrow button the operational screen of the selected loop will be displayed.

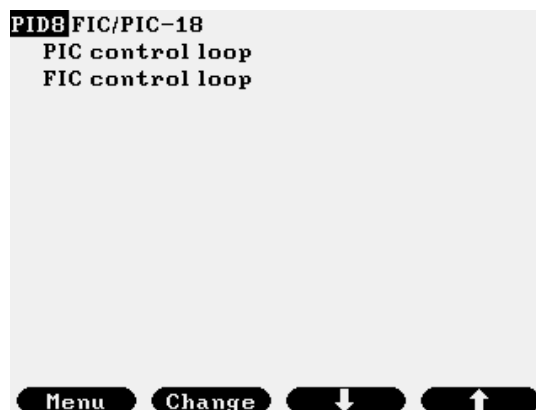

Figure 9-165 PID control operation, dual loop controller

The operational screen of the PIC loop is shown on the picture below.

PID8 FIC/PIC-18		PIC loop		PID8 FIC/PIC-18		PIC loop	
Loop identifier		FIC/PIC-18		PIC process variable		54.99 bar	
Dual PID loop type		Pout/max-qmax/q		PIC setpoint in use		54.99 bar	
Flow direction		(+) direction		Output signal in use		25.00 %	
PIC process variable		54.98 bar		Output signal mode		manual	
PIC setpoint in use		54.98 bar		A/M mode		manual	
Output signal in use		25.00 %		Setpoint mode		local SP	
Output signal mode		manual		Local SP / Poutmax / Pinmin		54.99 bar	
A/M mode		manual		Rem. SP/Poutmax/Pinmin		0.00 bar	
Setpoint mode		local SP		Output signal calcul-ed		25.00 %	
Local SP / Poutmax / Pinmin		54.98 bar		Manual output signal		25.00 %	
Rem. SP/Poutmax/Pinmin		0.00 bar		Rem. manual output sign.		0.00 %	
Output signal calcul-ed		25.00 %		Tuning set in use		Kp1Ti1Td1	
Manual output signal		25.00 %		Error status		---	

Figure 9-166 PID control operation, dual loop controller, PIC loop

Dual PID loop type	The control task selected during the set up for the dual loop controller (Pout/max – qmax/q or Pin/min – qmax/q) not alterable here.
Flow direction	Current flow direction, positive (+) or negative (-) indicated. Not alterable here.
PIC process variable	Current value of the process variable measured on the input channel
PIC setpoint in use	Value of the setpoint used in control (local or remote, depending on the setpoint mode).
Output signal in use	Output signal of the dual control block going to the analog output.
Output signal mode	Indicates which control loop calculated output signal goes to the output of the control block. Valid values are: PIC (if the calculated output signal of the PIC loop is in use) FIC (if the calculated output signal of the FIC loop is in use) Manual (if control loop in manual mode)
A/M mode	Auto/Manual mode of the controller, valid for both PIC and FIC loop, selected from the list: - auto; - manual.
Setpoint mode	Setpoint mode selection. Selected from list: - local (SP) - remote (RSP)
Local setpoint/Poutmax/ Pinmin	Entry field for local setpoint. In case of Pout/max – qmax/q control, value of the Poutmax In case of Pin/min – qmax/q control, value of the Pinmin If setpoint mode is set to remote and setpoint tracking is enabled then local setpoint follows the remote setpoint.
Remote setpoint/Poutmax/Pinmin	Indicates the value of the remote setpoint received on input channel or in Modbus register. In case of Pout/max – qmax/q control, value of the Poutmax In case of Pin/min – qmax/q control, value of the Pinmin
Output signal calculated	The calculated value of the PIC loop output signal.
Output signal manual	Entry field for the output signal. In manual mode it will be the in use output signal. In auto mode, if setpoint tracking is enabled, it follows the calculated value of the output signal.
Output signal remote manual	Manual value of the output signal written via Modbus register. Valid if output remote manual mode is enabled. If the PID loop in manual mode, then output signal can be modified writing the desired output signal value into the dedicated Modbus register. See Modbus register map in 13.6.4. The value written into the Modbus register must differ from the previous value of the register to be transferred to the output.
Tuning set in use	The tuning parameter set currently in use in the PIC loop. Selected from list: - Kp1Ti1Td1; - Kp2Ti2Td2.
Error status	Error status of the PIC loop. Valid error status: - no error

- PV invalid
- SP invalid

The operational screen of the FIC loop is shown on the picture below.

PIDB FIC/PIC-18		FIC loop	
Loop identifier		FIC/PIC-18	
Dual PID loop type	Pout/max-qmax/q	FIC process variable	19 995 m ³ /h
Flow direction	(+) direction	FIC setpoint in use	19 995 m ³ /h
FIC process variable	20 000 m ³ /h	Output signal in use	25.00 %
FIC setpoint in use	20 000 m ³ /h	Output signal mode	manual
Output signal in use	25.00 %	A/M mode	manual
Output signal mode	manual	Setpoint mode	local SP
A/M mode	manual	Local SP / qmax	19 995 m ³ /h
Setpoint mode	local SP	Remote SP / qmax	0 m ³ /h
Local SP / qmax	20 000 m ³ /h	Output signal calcul-ed	25.00 %
Remote SP / qmax	0 m ³ /h	Manual output signal	25.00 %
Output signal calcul-ed	25.00 %	Ren. manual output sign.	0.00 %
Manual output signal	25.00 %	Tuning set in use	Kp1Ti1Td1
		Error status	---

Figure 9-167 PID control operation, dual loop controller, FIC loop

Dual PID loop type	The control task selected during the set up for the dual loop controller (Pout/max – qmax/q or Pin/min – qmax/q) not alterable here.
Flow direction	Current flow direction, positive (+) or negative (-) indicated. Not alterable here.
FIC process variable	Current value of the process variable measured on the input channel or calculated in the metering stream.
FIC setpoint in use	Value of the setpoint used in control (local or remote, depending on the setpoint mode).
Output signal in use	Output signal of the dual control block going to the analog output.
Output signal mode	Indicates which control loop calculated output signal goes to the output of the control block. Valid values are: PIC (if the calculated output signal of the PIC loop is in use) FIC (if the calculated output signal of the FIC loop is in use) Manual (if control loop in manual mode)
A/M mode	Auto/Manual mode of the controller, valid for both PIC and FIC loop, selected from the list: - auto; - manual.
Setpoint mode	Setpoint mode selection, valid for both PIC and FIC loop, selected from list: - local (SP) - remote (RSP)
Local setpoint/qmax	Entry field for local setpoint. In case of Pout/max – qmax/q or Pin/min – qmax/q control, value of the qmax. If setpoint mode is set to remote and setpoint tracking is enabled then local setpoint follows the remote setpoint.
Remote setpoint/qmax	Indicates the value of the remote setpoint received on input channel or in Modbus register. In case of Pout/max – qmax/q control Pin/min – qmax/q control, value of the qmax.
Output signal calculated	The calculated value of the FIC loop output signal.
Output signal manual	Entry field for the output signal. In manual mode it will be the output signal in use. In auto mode, if setpoint tracking is enabled, it follows the calculated value of the output signal.
Output signal remote manual	Manual value of the output signal written via Modbus register. Valid if output remote manual mode is enabled. If the PID loop in manual mode, then output signal can be modified writing the desired output signal value into the dedicated Modbus register. See Modbus register map in 13.6.4. The value written into the Modbus register must differ from the previous value of the register to be transferred to the output.
Tuning set in use	The tuning parameter set currently in use in the FIC loop. Selected from list:

- Kp1Ti1Td1;
- Kp2Ti2Td2.

Error status

Error status of the FIC loop.
 Valid error status:
 - no error
 - PV invalid
 - SP invalid

9.2.7.5 Modbus register map of the PID control parameters

Uniflow-200 communication description see in Annex A. In this paragraph the Modbus register map related to PID control is described.

Table below gives the register addresses of the parameters which can be read or write via communication interface of Uniflow-200. Meaning of letter X in the register addresses in the table:

- X = 1 – for PID loop PID1
- X = 2 – for PID loop PID2
- ...
- X = 8 – for PID loop PID8

There are 2 sets of register addresses in the table, "Standard Modbus" and "Daniel Modbus".

If the communication with Uniflow-200 accomplished via serial port with port function set to "STD Modbus slave" or via Ethernet port with register assignment set to „STD Modbus" then "Standard Modbus" registers shall be addressed.

If the communication with Uniflow-200 accomplished via serial port with port function set to "Daniel Modbus slave" or via Ethernet port with register assignment set to „Daniel Modbus" then "Daniel Modbus" registers shall be addressed.

Changing the "modes" shall be done writing the appropriate code into registers marked with rw (read/write). Statuses shall be read from the registers marked with ro (read only).

No.	Description	Standard Modbus register address	Daniel Modbus register address	rw= read/write ro= read only int=16 bit integer float=32 bit float	Note
1	A/M mode selection: 1 – auto, 2 – manual	15X00	15X00	int rw	For single loop control
2	Setpoint mode selection: 1 – local, 2 - remote	15X01	15X01	int rw	
3	Tuning set selection: 1 – PID1, 2 – PID2	15X02	15X02	int rw	
4	A/M mode selection: 1 – auto, 2 – manual (common for PIC and FIC)	15X03	15X03	int rw	For dual loop control
5	Setpoint mode selection: 1 – local, 2 – remote (common for PIC and FIC)	15X04	15X04	int rw	
6	Tuning set selection for PIC loop: 1 – PID1, 2 - PID2	15X05	15X05	int rw	
7	Tuning set selection for FIC loop: 1 – PID1, 2 - PID2	15X06	15X06	int rw	
8	Flow direction: 1 – (+)positive, 2 - (-)negative	15X07	15X07	int rw	General settings
9	PID loop status: 1 – active, 2 – inactive	15X08	15X08	int ro	
10	PID loop type: 1 – single loop, 2 – dual loop unidirectional, 3 – dual loop bidirectional	15X09	15X09	int ro	
11	Dual PID loop type: 1 - Pout/max – qmax/q, 2 - Pin/min – qmax/q	15X10	15X10	int ro	For single loop control
12	A/M mode status: 1 – auto, 2 - manual	15X11	15X11	int ro	
13	Setpoint mode status: 1 – local, 2 - remote	15X12	15X12	int ro	
14	Tuning set status: 1 – PID1, 2 – PID2	15X13	15X13	int ro	

15	Error status (bitwise coded): bit0 – no error, bit1- PV invalid, bit2 – SP invalid	15X14	15X14	int ro	
16	A/M mode status: 1 – auto, 2 – manual (common for PIC and FIC)	15X15	15X15	int ro	For dual loop control
17	Setpoint mode status: 1 – local, 2 - remote	15X16	15X16	int ro	
18	Tuning set status for PIC loop: 1 – PID1, 2 – PID2	15X17	15X17	int ro	
19	Tuning set status for FIC loop: 1 – PID1, 2 – PID2	15X18	15X18	int ro	
20	Error status for PIC loop (bitwise coded): bit0 – no error, bit1- PV invalid, bit2 – SP invalid	15X19	15X19	int ro	
21	Error status for FIC loop (bitwise coded): bit0 – no error, bit1- PV invalid, bit2 – SP invalid	15X20	15X20	int ro	
22	Flow direction status: 1 – (+)positive, 2 - (-)negative	15X21	15X21	int ro	
23	Remote set point	15X22	15X22	float rw	For single loop control
		15X23			
24	Output remote manual signal	15X24	15X23	float rw	For dual loop control
		15X25			
	PIC loop rempte setpoint/Poutmax/Pinmin	15X26	15X24	float rw	For dual loop control
		15X27			
26	not used	15X28	15X25	float rw	For dual loop control
		15X29			
27	FIC loop remote setpoint/qmax	15X30	15X26	float rw	For dual loop control
		15X31			
28	Output remote manual signal	15X32	15X27	float rw	For single loop control
		15X33			
	Process variable	15X34	15X28	float ro	For single loop control
		15X35			
30	Setpoint in use	15X36	15X29	float ro	For single loop control
		15X37			
31	Output signal in use	15X38	15X30	float ro	For single loop control
		15X39			
32	Local setpoint	15X40	15X31	float ro	For single loop control
		15X41			
33	Output signal calculated	15X42	15X32	float ro	For single loop control
		15X43			
34	Output signal manual	15X44	15X33	float ro	For single loop control
		15X45			
	PIC loop process variable	15X46	15X34	float ro	For dual loop control
		15X47			
36	PIC loop setpoint in use	15X48	15X35	float ro	For dual loop control
		15X49			
37	PIC loop output signal calculated	15X50	15X36	float ro	For dual loop control
		15X51			
38	PIC loop local setpoint	15X52	15X37	float ro	For dual loop control
		15X53			
39	PIC loop remote setpoint	15X54	15X38	float ro	For dual loop control
		15X55			
40	FIC loop process variable	15X56	15X39	float ro	For dual loop control
		15X57			
41	FIC loop setpoint in use	15X58	15X40	float ro	For dual loop control
		15X59			
42	FIC loop output signal calculated	15X60	15X41	float ro	

		15X61			
43	FIC loop local setpoint	15X62	15X42	float ro	
		15X63			
44	FIC loop remote setpoint	15X64	15X43	float ro	
		15X65			
45	Output signal in use	15X66	15X44	float ro	
		15X67			
46	Output signal manual	15X68	15X45	float ro	
		15X69			

Table 9-15 Modbus register map of the PID control parameters

9.3 Alarms and events system

UNIFLOW-200 operates a comprehensive alarming and eventing system, a summary of which is described below.

Alarm is considered as a violation of a limit set in the flow computer by operator or by the calculation procedure implemented.

Event is considered any change in the parameter set of the flow computer.

When an alarm occurs, it causes:

- visual alarm indication (alarm LED on the front panel) flashing;
- digital alarm output activated;
- entry is added to the unacknowledged alarm list;
- entry is added to the alarm log (alarm set).

When operator acknowledges the alarm:

- it is moved from the unacknowledged alarm list to the acknowledged alarm list;
- alarm led is lit (not flashing);

When the limit violation causing the alarm disappears:

- alarm LED goes off;
- digital alarm output deactivated;
- alarm is cleared from the alarm list (from the acknowledged alarm list if it was acknowledged and from the unacknowledged alarm list if it was not acknowledged. Alarm system works on unlatched basis)
- entry is added to the alarm log (alarm cleared).

When any event appears:

- entry is added to event log indicating the name of the parameter modified, the old value and the new value of the parameter.

There is also a download log in the flow computer. It serves for archiving the natural gas composition downloaded to the flow computer from supervisory system via the Modbus link.

Every time a new gas composition is received on the Modbus link the composition is stored in the download log as a new entry.

The alarm log, event log and download log content is not alterable.

9.3.1 I/O channel alarms

9.3.1.1 Analog input channel (4-20 mA) alarms

Alarm text	Description
IO../Ch.. Under range	Current < 3.5 mA. Alarm is cleared with hysteresis when current > 4 mA. In the range 3.5 mA < current < 4.0 mA current = 4.0 mA converted into engineering unit.
IO../Ch.. Over range	Current > 20.5 mA. Alarm is cleared with hysteresis when current < 20 mA. In the range 20.0 mA < current < 20.5 mA the measured current is converted into engineering unit.
IO../Ch.. LoLo limit	Parameter in engineering unit < LoLo alarm limit
IO../Ch.. Lo limit	Parameter in engineering unit < Lo alarm limit
IO../Ch..Hi limit	Parameter in engineering unit > Hi alarm limit
IO../Ch..HiHi limit	Parameter in engineering unit > HiHi alarm limit
IO../Ch.. channel failure	Channel data is failed to read
Str.. dP cut-off active	For differential pressure channel only. Measured dP < dP cut-off limit. dP = 0 assumed in flow calculation.
Str.. dP transmitter discrepancy	For differential pressure channel only if two or three dP transmitters with identical range is configured. Deviation between the differential pressures measured at different channels > deviation limit.

Differential pressure signal processing in different regions of the input signal is shown in the table below.

dP_max	-----	transmitter overload (I > 20.5 mA)
dP_HI_current	-----	transmitter upper range value (I = 20.0 mA)
dP_cut-off	-----	dP cut-off limit
dP_LO_current	-----	transmitter lower range value (I = 4.0 mA)
dP_min	-----	open input circuit (I < 3.5 mA)

dP range	Alarm	dP signal processing
0 < dP < dP_min	Under-range	No flow calculation
dP_min < dP < dP_LO_current	Under-range	No flow calculation
dP_LO_current < dP < dP_cut-off	dP cut-off active	dP = 0 assumed
dP_cut-off < dP < dP_HI_current	none	normal flow calculation
dP_HI_currnt < dP < dP_max	none	normal flow calculation
dP_max < dP	Over-range	dp = dP_max assumed, fault totals

NOTE

It is operator selectable in the signal setup menu if the under range, over range and Lo, LoLo, Hi, HiHi limits shall generate alarm or not.

9.3.1.2 PRT/RTD (Pt100) channel alarms

Alarm text	Description
IO../Ch.. Under range	Temperature < LO_scale.
IO../Ch.. Over range	Temperature > HI_scale.
IO../Ch.. LoLo limit	Temperature < LoLo alarm limit
IO../Ch.. Lo limit	Temperature < Lo alarm limit
IO../Ch..Hi limit	Temperature > Hi alarm limit
IO../Ch..HiHi limit	Temperature > HiHi alarm limit

NOTE

It is operator selectable in the signal setup menu if the under range, over range and limits shall generate alarm or not.

9.3.1.3 Pulse input channel (flow pulse signal) alarms

Alarm text	Description
Str.. flowrate cut-off active	UVOL flowrate < cut-off flowrate
Str.. flowrate below qmin	UVOL flowrate < qmin flowrate

IO../Ch.. LoLo limit	UVOL flowrate < LoLo alarm limit
IO../Ch.. Lo limit	UVOL flowrate < Lo alarm limit
IO../Ch..Hi limit	UVOL flowrate > Hi alarm limit
IO../Ch..HiHi limit	UVOL flowrate > HiHi alarm limit
Str.. flowrate above qmax	UVOL flowrate > qmax flowrate
Str.. meter overload	UVOL flowrate > $t_m * q_{max}$ flowrate
Str.. meter critical overload	UVOL flowrate > $1.5 * t_m * q_{max}$ flowrate

where t_m is the maximum overload set in the signal setup menu

Pulse input signal processing in different regions of the input signal is shown in the table below.

$1.5 * t_m * q_{max}$	-----	critical overload flowrate
$t_m * q_{max}$	-----	maximum overload flowrate
q_{max}	-----	maximum UVOL flowrate
q_{min}	-----	minimum UVOL flowrate
$q_{cut-off}$	-----	cut-off UVOL flowrate
0	-----	no flow

UVOL FR range	Alarm	Signal processing
$0 < UVOL\ FR < q_{cut-off}$	flowrate cut-off active	No flow totalization
$q_{cut-off} < UVOL\ FR < q_{min}$	under range	Fault totals
$q_{min} < UVOL\ FR < q_{max}$	none	Normal flow calculation
$q_{max} < UVOL\ FR < t_m * q_{max}$	over range	Fault totals
$t_m * q_{max} < UVOL\ FR < 1.5 * t_m * q_{max}$	overload	Fault totals
$1.5 * t_m * q_{max} < UVOL\ FR$	critical overload	No data (----) is displayed for all flow rates. No flow totalization

The flowrate is calculated in any cases independently on that if the totalization is allowed or not.

NOTE

It is operator selectable in the signal setup menu if the Lo, LoLo, Hi, HiHi limits shall generate alarm or not.

9.3.1.4 Pulse input channel (flow frequency signal) alarms

Alarm text	Description
IO../Ch.. Under range	Frequency < LO_frequency
IO../Ch.. Over range	Frequency > HI_frequency
IO../Ch.. LoLo limit	Parameter in engineering unit < LoLo alarm limit
IO../Ch.. Lo limit	Parameter in engineering unit < Lo alarm limit
IO../Ch..Hi limit	Parameter in engineering unit > Hi alarm limit
IO../Ch..HiHi limit	Parameter in engineering unit > HiHi alarm limit

NOTE

It is operator selectable in the signal setup menu if the under range, over range and Lo, LoLo, Hi, HiHi limits shall generate alarm or not.

9.3.1.5 Pulse input channel (density frequency signal) alarms

Alarm text	Description
IO../Ch.. Under range	Parameter in engineering unit < LO_scale
IO../Ch.. Over range	Parameter in engineering unit > HI_scale
IO../Ch.. LoLo limit	Parameter in engineering unit < LoLo alarm limit
IO../Ch.. Lo limit	Parameter in engineering unit < Lo alarm limit
IO../Ch..Hi limit	Parameter in engineering unit > Hi alarm limit
IO../Ch..HiHi limit	Parameter in engineering unit > HiHi alarm limit

NOTE

It is operator selectable in the signal setup menu if the under range, over range and Lo, LoLo, Hi, HiHi limits shall generate alarm or not.

9.3.1.6 Analog output (4-20 mA) channel alarms

Alarm text	Description
IO../Ch.. Under range	Parameter in engineering unit < LO_scale
IO../Ch.. Over range	Parameter in engineering unit > HI_scale
IO../Ch.. LoLo limit	Parameter in engineering unit < LoLo alarm limit
IO../Ch.. Lo limit	Parameter in engineering unit < Lo alarm limit
IO../Ch..Hi limit	Parameter in engineering unit > Hi alarm limit
IO../Ch..HiHi limit	Parameter in engineering unit > HiHi alarm limit

NOTE

It is operator selectable in the signal setup menu if the under range, over range and Lo, LoLo, Hi, HiHi limits shall generate alarm or not.

9.3.1.7 Pulse output channel alarms

Alarm text	Description
IO../Ch.. Pulse output overload	Number of pulses to be output > 10 sec * max. output frequency

This alarm may appear if a digital output is configured to output pulses proportional to total and the K-factor (volume/pulses) is improperly set. If the number of accumulated pulses to be output is more than the number of pulses the flow computer capable to output at maximum frequency during 10 seconds then pulse output overload alarm appears.

9.3.1.8 Modbus (serial communication) channel alarms

Alarm text	Description
Str.. data update timeout	No new data is received within the timeout time.

This alarm appears if the Modbus channel signal is not updated (not written by external device) within the timeout time specified in the signal setup menu for that channel.

9.3.2 Metering stream alarms

9.3.2.1 Calculation alarms

This type of alarms related to the calculation algorithm implemented for particular flow calculation. The alarms and the consequences in the flow calculation listed in the table below.

Alarm text	Cause of alarm	Consequences
Gas composition out of range	The total of the natural gas component concentrations received on Modbus link is outside the 95 ... 105 % range	Alarm and keypad composition is used in the calculation
Gas quality out of range	One or more component concentration is outside the range defined in the calculation standard (e.g. AGA8).	Alarm but the calculation proceeds.
Gas quality out of extended range	One or more component concentration is outside the extended range defined in the calculation standard (e.g. AGA8).	Alarm and the calculation proceeds.
Turbine input error	Error in the main and check pulse train ratio.	Alarm but the calculation proceeds.
dP/P ratio out of range	The dP/P ratio out of the range determined by the standard.	Alarm but the calculation proceeds.
Pipe diameter out of the range	The pipe diameter out of the range determined by the standard.	Alarm but the calculation proceeds.
Orifice diameter out of the range	The orifice diameter out of the range determined by the standard.	Alarm but the calculation proceeds.
Beta ratio out of the range	The beta ration out of the range determined by the standard.	Alarm but the calculation proceeds.
Reynolds number out of the range	The Reynolds number out of the range determined by the standard.	Alarm but the calculation proceeds.
ISO5167 calculation fail	No convergence is reached in the ISO 5167 calculation within 10 iterative cycle.	Alarm and the calculation stops.
AGA8 calculation fail	No convergence is reached in the AGA 8 calculation within 10 iterative cycle.	Alarm and the calculation stops.

I/O channel signal representing flow (for example differential pressure or pulse input from turbine meter) has no keypad value. In case of failure of this kind of signals the flow calculation is stopped.

I/O signal other then flow signal (for example pressure or temperature) has keypad value. In case of failure of this kind of signal the flow calculation is continued with the keypad value of the signal.

The complete list of alarms and events listed in 9.3.4.

9.3.2.2 Stream fault alarm

This is a common alarm for the stream.

If any of the stream related alarm(s) (see list in the 9.3.4.) is active, the stream fault alarm will be activated and entry into the alarm log will be registered.

Stream fault alarm can be assigned to any digital output so that the status of the digital output will indicate presence of the stream fault alarm.

9.3.3 Common alarm and status output

Common alarm

A common alarm is defined in UNIFLOW-200.

If any of the I/O or metering stream alarm is active then the common alarm becomes active as well.

The common alarm can be assigned to a digital output channel providing alarm signal for external devices.

The alarm LED on the front panel and the common alarm output change their state as indicated in the table below.

Common alarm	Alarm LED	Alarm output
unacknowledged alarm exists	flashing red	open(*)
acknowledged alarm only exists	constant red	open(*)
no alarm	not lit	closed(*)

(*) The digital output can be configured to be normally open or normally closed.

9.3.3.1 Status output

The run LED on the front panel and the change over voltage free contact output is provided to signal the operational status/fault of the flow computer.

The run LED and the status output change their state as indicated in the table below.

Flow computer status	RUN LED	Status output	
		In operation output	In fault output
Operating	lit	closed	open
Faulty	not lit	open	closed

9.3.4 Alarm list

Potential alarms in UNIFLOW-200 are listed in the table below.

Entry is created in the **alarmlog.txt** file when any of these alarms appear (SET), acknowledged (ACK) and disappear (CLR).

I/O Channel related alarms

No.	Prefix	Alarm	Description
1	IOn/Chm	Data update timeout	No new data is received within the timeout time.
2	IOn/Chm	Hi limit	Measured value > Hi alarm limit
3	IOn/Chm	HiHi limit	Measured value > HiHi alarm limit
4	IOn/Chm	IO channel failure	Channel data is failed to read
5	IOn/Chm	Lo limit	Measured value < Lo alarm limit
6	IOn/Chm	LoLo limit	Measured value < LoLo alarm limit
7	IOn/Chm	Over range	Measured value > Hi scale
8	IOn/Chm	Pulse input overload	Measured frequency > 12 kHz
9	IOn/Chm	Pulse output overload	Pulses to be output requires more then 10 s
10	IOn/Chm	Under range	Measured value < Lo scale

Stream related alarms

No.	Prefix	Alarm	Description
1	Strn	AGA8 calculation fail	No convergence is reached in the AGA 8 calculation within 10 iterative cycles.
2	Strn	AGA8 extended over-range	Gas composition out of the extended AGA8 range
3	Strn	AGA8 over-range	Gas composition out of the AGA8 range
4	Strn	Base density out of range	Base density out of the range determined by the standard
5	Strn	Beta ratio out of the range	The beta ratio out of the range determined by the standard.
6	Strn	Critical over load	UVOL flowrate > 1.5 * tm * qmax
7	Strn	CVOL FR above prem.limit	Volume at base conditions flow rate above premium limit
8	Strn	CVOL FR above prem.limit	Volume at base conditions flow rate premium limit warning
9	Strn	Densitometer error	Error in densitometer signal
10	Strn	Density calculation fail	No convergence is reached in the density calculation within 10 iterative cycles.
11	Strn	Density converg error	Density calculation convergence error
12	Strn	Density discrepancy	Deviation between the densities measured in two densitometers > deviation limit.
13	Strn	dP cut-off active	Measured dP < dP cut-off limit

14 Strn	dP transmitter discrepancy	Deviation between the differential pressures measured at different channels > deviation limit.
15 Strn	dP/P ratio out of range	The dP/P ratio out of the range determined by the standard
16 Strn	Dynamic viscosity error	Dynamic viscosity error
17 Strn	ENGY FR above prem.limit	Energy flow rate above premium limit
18 Strn	ENGY FR above prem.limit	Energy flow rate premium limit warning
19 Strn	Flowrate cut-off active	$0 < \text{UVOL flowrate} < q_{\text{cut-off}}$
20 Strn	Gas composition out of range	The total of the natural gas component concentrations received on Modbus link is outside the 95 ... 105 % range
21 Strn	Gas quality out of extended range	One or more component concentration is outside the extended range defined in the calculation standard (e.g. AGA8).
22 Strn	Gas quality out of range	One or more component concentration is outside the range defined in the calculation standard (e.g. AGA8).
23 Strn	Gas quality update timeout	No new gas composition data is received within the timeout time.
24 Strn	Increment OOR	Integration increment out of range
25 Strn	Invalid fluid	Invalid fluid selection
26 Strn	ISO5167 calculation fail	No convergence is reached in the ISO 5167 calculation within 10 iterative cycles.
27 Strn	Joule-Thomson Err.	Joule-Thomson coefficient calculation error
28 Strn	Line dens. error	Line density error
29 Strn	Mass FR above prem.limit	Mass flow rate above premium limit
30 Strn	Mass FR above prem.limit	Mass flow rate premium limit warning
31 Strn	Modbus slave error	Modbus slave error
32 Strn	NGL/LPG Consistency Error	NGL/LPG calculation consistency error
33 Strn	NGL/LPG Ctl Error	NGL/LPG Ctl error
34 Strn	NGL/LPG Ctl iteration Error	NGL/LPG Ctl iteration error
35 Strn	NGL/LPG Gamma60 Error	NGL/LPG calculation gamma60 error
36 Strn	NGL/LPG Gamma60 iteration Error	NGL/LPG calculation gamma60 iteration error
37 Strn	NGL/LPG range Error	NGL/LPG calculation range error
38 Strn	NGL/LPG Tr > Tc Error	NGL/LPG Tr > Tc error
39 Strn	Orifice diameter out of the range	The Orifice diameter out of the range determined by the standard.
40 Strn	Out of range PT	Pressure and tempearture out of range
41 Strn	Over load	$\text{UVOL flowrate} > t_m * q_{\text{max}}$ ($t_m = \text{max. load, \%}$)
42 Strn	Over range	$\text{UVOL flowrate} > q_{\text{max}}$
43 Strn	P2/P ratio out of range	The P2/P ratio out of the range determined by the standard
44 Strn	Pipe diameter out of the range	The pipe diameter out of the range determined by the standard.
45 Strn	Press. > Steam sat. press.	Pressure > Steam saturation pressure
46 Strn	Pressure extend OOR	Pressure out of extended range
47 Strn	Pressure OOR	Pressure out of range
48 Strn	Product selection failure	Failed to determine the type of refined product on the basis of base density
49 Strn	Pulse input error	Error in the main and check pulse train ratio.
50 Strn	Reynolds number out of the range	The Reynolds number out of the range determined by the standard
51 Strn	Steam calculation failed	Steam calculation failed
52 Strn	Steam calculation warning	Steam calculation warning
53 Strn	Steam sat. press. alarm	Steam saturation pressure alarm
54 Strn	Structural dP overload	Differential pressure > structural maximum dP for Annubar

55 Strn	Temperature out of extended range	The temperature out of the extended range determined by the standard
56 Strn	Temperature out of range	The temperature out of the range determined by the standard
57 Strn	Transmitter setting failure	Failed to set the transmitter range
58 Strn	Under range	UVOL flowrate < qmin
59 Strn	UVOL FR above prem.limit	Volume at line conditions flow rate above premium limit
60 Strn	UVOL FR above prem.limit	Volume at line conditions flow rate premium limit warning
61 Strn	VCR out of range	Volume correction factor out of range
62 Strn	Water not liquid	Error in water-steam phase calculation
63 Strn	US meter common alarm	Alarm state is active in the US meter assigned to the stream n.

9.3.5 Events list

Events in UNIFLOW-200 are listed in the table below.
Entry is created in the **eventlog.txt** file when any of these events appear.

No.	Prefix	Alarm	Description
1	date/time	Application software update	Application software updated
2	date/time	Date/time downloaded	Date/time updated via Modbus
3	date/time	DST off	Daylight saving time period ended (European DST rule is followed)
4	date/time	DST off failed	Failed to end daylight saving time period
5	date/time	DST on	Daylight saving time period started (European DST rule is followed)
6	date/time	DST on failed	Failed to start daylight saving time period
7	date/time	Engineer logged in	Operator at engineer password level logged in
8	Strn	General reset	All the parameters, totals, alarms, event are cleared for all streams
9	date/time	Guest logged in	Operator at guest password level logged in
10	date/time	IP address conflict	IP address conflict
11	Strn	New gas composition received	New gas composition received
12	date/time	no. of calc. cycles	Number of calculation cycles
13	date/time	Operator logged in	Operator at operator password level logged in
14	date/time	Parameter setup aborted	Parameter setup aborted
15	date/time	Parameter setup start	Operator entered Parameters menu
16	date/time	Parameter setup stop	Operator left Parameters menu
17	date/time	Power failure	Power failure or power off
18	date/time	Remote parameter setup	Parameters are modified via ethernet interface
19	Strn	Totals reset	Totals are cleared to the selected streams
20	date/time	Warm start	Flow computer restarted after power on or application download
21	date/time	Watchdog restart	Flow computer restarted from watchdog circuit

9.3.6 Download log

Gas composition downloaded into UNIFLOW-200 is stored in the **downloadlog.txt** file.
The structure of the file is as follows.

In case of measuring natural gas using Modbus Daniel mode for the first stream:

Line	Modbus registers (Modb.
1.	Daniel): ;7001;7002;7003;7004;7005;7006;7007;7008;7009;7010;7011 ;7012;7013;7014;7015;7016;70

Line 2.	Parameters: ;N2;CO2;H2S;H2O;He;C1;C2;C3;nC4;iC4;nC5;iC5;nC6;nC7;nC8;nC9;nC10;O2;CO ;H2;rRo;ICV;SCV;Ar;LD;BD;
Line <i>n</i> .	Timestamp Str1 ;gas composition data

In case of measuring natural gas using Modbus STD1 mode for all streams:

Line 1.	Modbus registers (Modb. STD1): ;818;820;822;824;826;828;830;832;834;836;838;840;842;844;846;848;850;852;854;856; 858;860;
Line 2.	Parameters: ;N2;CO2;H2S;H2O;He;C1;C2;C3;nC4;iC4;nC5;iC5;nC6;nC7;nC8;nC9;nC10;O2 ;CO;H2;RD;ICV;
Line <i>n</i> .	Timestamp Str1-8 ;gas composition data

In case of measuring natural gas using Modbus STD2 mode for the first stream:

Line 1.	Modbus registers (Modb. STD2): ;878;880;882;884;886;888;890;892;894;896;898;900;902 ;904;906;908;910;912;914;916;918;920;870;872;874;876;
Line 2.	Parameters: ;N2;CO2;H2S;H2O;He;C1;C2;C3;nC4;iC4;nC5;iC5;nC6;nC7;nC8;nC9;nC10;O2 ;CO;H2;RD;ICV;SCV;Ar;LD;BD
Line <i>n</i> .	Timestamp Str1 ;gas composition data

In case of measuring coke oven gas using Modbus Daniel mode for the first stream:

Line 1.	Modbus registers (Modb. Daniel): ;7001;7002;7003;7004;7006;7007;7008;7018;7019;7020 ;7028;7029;
Line 2.	Parameters: ;N2;CO2;H2S;H2O;C1;C2;C3;O2;CO;H2;Ammonia;Benzene;
Line <i>n</i> .	Timestamp Str1 ;gas composition data

In case of measuring coke oven gas using Modbus STD2 mode for the first stream:

Line 1.	Modbus registers (Modb. STD2): ;878;880;882;884;888;890;892;912;914;916;1310;1312;
Line 2.	Parameters: ;N2;CO2;H2S;H2O;C1;C2;C3;O2;CO;H2;Ammonia;Benzene;
Line <i>n</i> .	Timestamp Str1 ;gas composition data

In case of measuring blast furnace gas using Modbus Daniel mode for the first stream:

Line 1.	Modbus registers (Modb. Daniel): ;7001;7002;7004;7019;7020;
Line 2.	Parameters: ;N2;CO2;H2O;CO;H2;
Line <i>n</i> .	Timestamp Str1 ;gas composition data

In case of measuring blast furnace gas using Modbus STD2 mode for the first stream:

Line 1.	Modbus registers (Modb. STD2): ;878;880;884;914;916;
Line 2.	Parameters: ;N2;CO2;H2O;CO;H2;
Line <i>n</i> .	Timestamp Str1 ;gas composition data

9.4 Tests

The Test menu is intended for quick check of the I/O signals of the flow computer. It also includes menu items to monitor data exchange on serial ports and on the Modbus TCP port. Entering Tests menu does not interrupt the flow calculation of the metering streams however it may affect the output signals.

NOTE

Remove all the field output signal connectors from the flow computer before entering the Test menu. The test values of the output signals (current on the 4-20 mA output channel and state on the digital output channel) set in the Tests menu will appear on the output terminals of the flow computer. These artificial outputs may disturb the normal operation of the equipment connected to the flow computer.

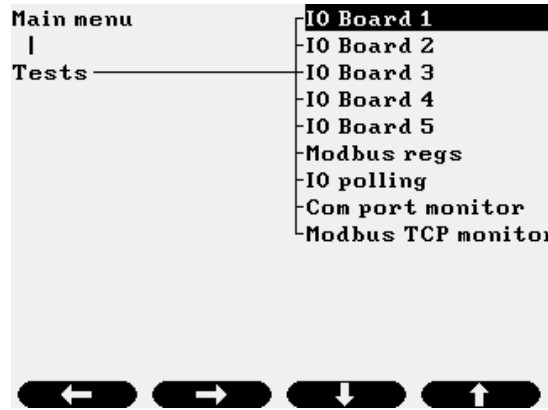

Figure 9-168 Tests – main menu page

There are separate data pages for each I/O board inserted. Information displayed on the data pages, depending on the type of the I/O board, are shown on the figures below.

9.4.1 Tests – ANI4PT2 board

Route in the menu tree:

Tests Board n.

where n number of slots the board is inserted

Function of the F keys on the Tests – ANI4PT2 board data pages

Menu returns to the parent menu

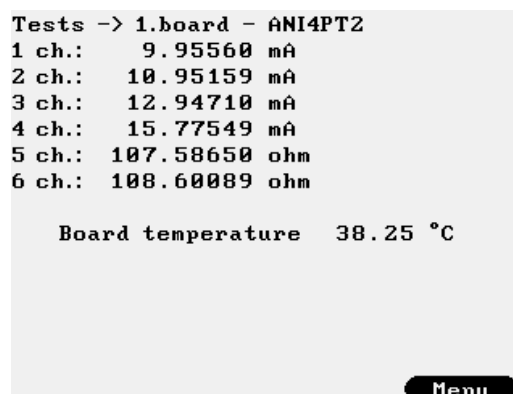

Figure 9-169 Tests – ANI4PT2 board data page

The current in mA and the resistance in Ohms are indicated for each channel. The temperature of the board inside the instrument case is also indicated.

9.4.2 Tests – ANI8 board

Route in the menu tree:

Tests Board n.

where n number of slots the board is inserted

Function of the F keys on the Tests – ANI8 board data pages

Menu returns to the parent menu

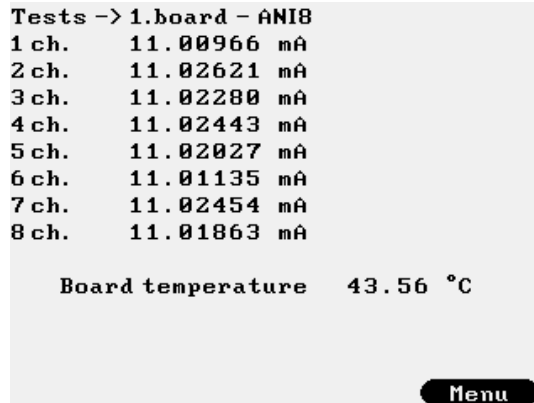

Figure 9-170 Tests – ANI8 board data page

The current in mA is indicated for each channel.

The temperature of the board inside the instrument case is also indicated.

9.4.3 Tests – PT4 board

Route in the menu tree:

Tests Board n.

where n number of slots the board is inserted

Function of the F keys on the Tests – PT4 board data pages

Menu returns to the parent menu

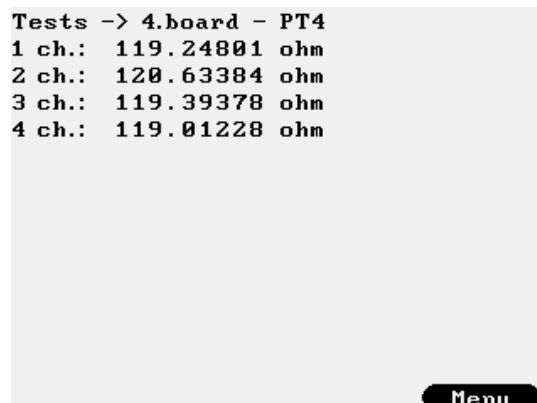

Figure 9-171 Tests – PT4 board data page

The resistance in Ohms is indicated for each channel.

The temperature of the board inside the instrument case is also indicated.

9.4.4 Tests – AODIO484 board

Route in the menu tree:

Tests Board n.

where n number of slots the board is inserted

Function of the F keys on the Tests – AODIO484 board data page

↓ select the next field for editing

↑ select the previous field for editing

Change modify the selected data field

OK Confirm the selection

Menu returns to the parent menu

Tests -> 5.board - AODIO484		Tests -> 5.board - AODIO484	
Analog outputs:		Digital inputs:	
1 ch. Analog output	12.800 mA	5 ch. Dual state input	opened
2 ch. Analog output	7.5728 mA	6 ch. Dual state input	opened
3 ch. Analog output	4.0000 mA	7 ch. Dual state input	opened
4 ch. Analog output	0.0000 mA	8 ch. Dual state input	opened
Digital inputs:		Digital outputs:	
5 ch. Dual state input	opened	13 ch. Dual state output	opened
6 ch. Dual state input	opened	14 ch. Dual state output	opened
7 ch. Dual state input	opened	15 ch. Dual state output	opened
8 ch. Dual state input	opened	16 ch. Dual state output	opened
9 ch. Dual state input	opened		
10 ch. Dual state input	opened		
11 ch. Dual state input	opened		

Figure 9-172 Tests – AODIO484 board data page

The current in mA is indicated for the analog output channels.

The state (opened or closed) is indicated for digital input and output channels.

Selecting analog output channel any current from 0 to 21 mA can be entered. UNIFLOW-200 drives the selected output to the set current.

Selecting digital output channel the state of the channel can be set to open or closed.

Leaving the data page UNIFLOW-200 restores the outputs to the value determined by the application.

9.4.5 Tests – PDIO484 board

Route in the menu tree:

Tests Board n.

where n number of slots the board is inserted

Function of the F keys on the Tests – PDIO484 board data page

↓ select the next field for editing

↑ select the previous field for editing

Change modify the selected data field

OK Confirm the selection

Menu returns to the parent menu

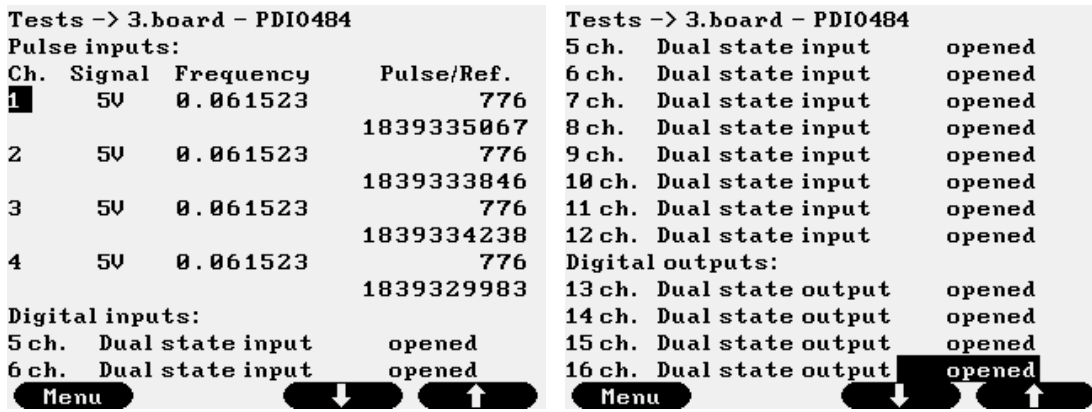

Figure 9-173 Tests – PDI0484 board data page

The frequency and the pulse counter for the main and check pulse inputs are indicated for the pulse input channels. The state (opened or closed) is indicated for digital input and output channels.

Selecting digital output channel the state of the channel can be set to opened or closed.

Leaving the data page UNIFLOW-200 restores the outputs to the value determined by the application.

9.4.6 Tests – PITC4641 board

Route in the menu tree:

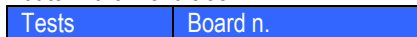

where *n* number of slots the board is inserted

Function of the F keys on the Tests – PITC4641 board data page

↓ select the next field for editing

↑ select the previous field for editing

Change modify the selected data field

OK Confirm the selection

Menu returns to the parent menu

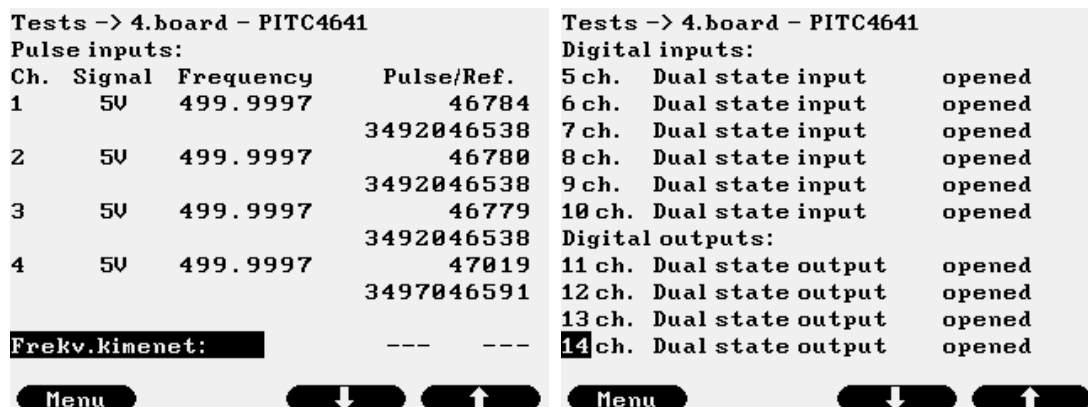

Figure 9-174 Tests – PITC4641 board data page

The frequency and the pulse counter for the main and check pulse inputs are indicated for the pulse input channels. Frequency output indicates the frequency passed from one of the pulse input channels to the raw pulse output channel. Active when one of the streams defined in the flow computer is selected for proving in the connecting prover computer. See in Uniflow-200 Prover Computer Instruction Manual.

The state (opened or closed) is indicated for digital input and output channels.

Selecting digital output channel, the state of the channel can be set to opened or closed.

Leaving the data page UNIFLOW-200 restores the outputs to the value determined by the application.

9.4.7 Tests – Com port monitor

Route in the menu tree:



Entering the Com port monitor menu, a warning message will be displayed: “When using Com port monitor, ensure that only one client is polling the Com port.”

Pressing OK, lead us to the setup data page.

Function of the F keys on the Tests – Com port monitor, setup pages

↓ select the next field for editing

↑ select the previous field for editing

Change modify the selected data field

OK Confirm the selection

Start start monitoring the traffic on the Com port

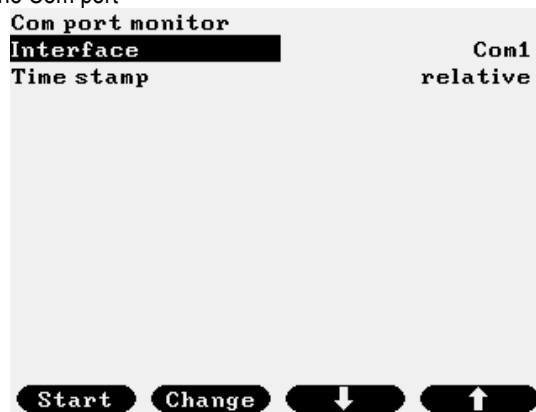

Figure 9-175 Tests – Com port monitor, setup

The data fields on the data page are as follows:

- Interface;
 - Com1;
 - Com2;
 - Com3;
- Time stamp;
 - absolute; (real time clock time)
 - relative; (start of the monitoring is considered as zero time)
 - between messages; (time elapsed between messages is displayed)

After selecting the Com port and timestamp format, the Start button leads us to the monitoring page.

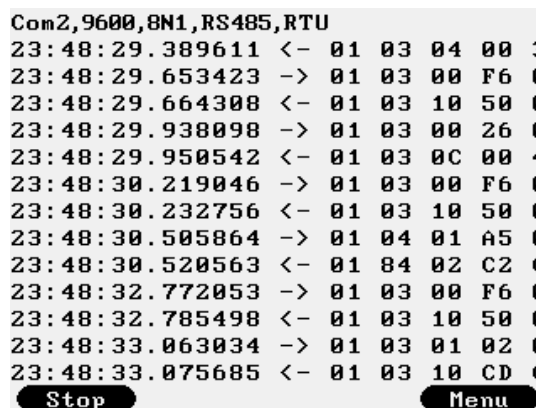

Figure 9-176 Tests – Com port monitor, traffic

The header line shows the com port being monitored and its settings. The page shows the received messages (denoted with ←) and the sent messages (denoted with →). The lines are scrolling up as new messages received and sent. Due to limited size of the display the whole messages cannot be shown while the lines are scrolling. To evaluate the messages, Stop button shall be pressed.

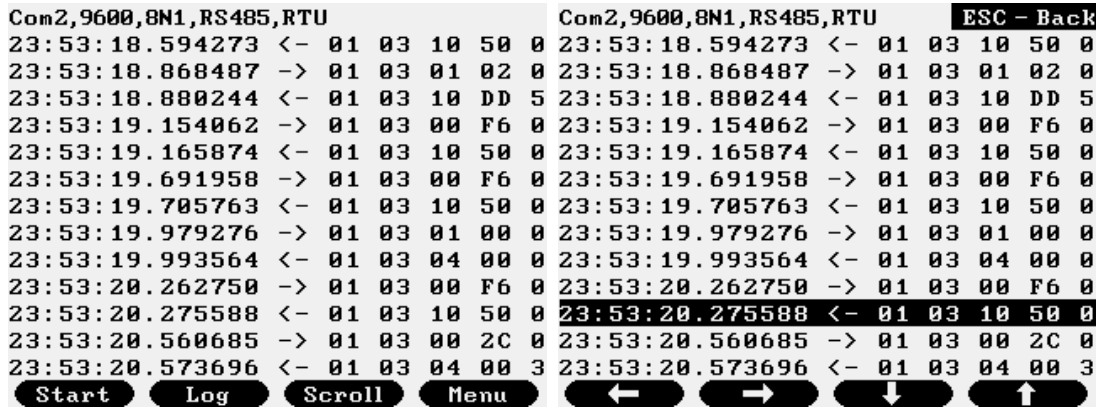

Figure 9-177 Tests – Com port monitor, scrolling

Function of the F keys

Start restart the monitoring

Log save traffic into log file

Scroll allows scrolling up and down and right and left between the messages (F keys change to arrows)

Menu returns to the parent menu

Pressing the Log button, a log file will be created and the traffic data will be saved into the log file.

The log file can be transferred to flash drive and can be transferred to the PC hard drive with the UNIArchive software of the ToolBox suit.

The log file name convention is as follows:

comN_yyyy_mm_dd_hh_mm_ss.txt

where

N - serial number of the Com port monitored

yyyy_mm_dd_hh_mm_ss - is the time stamp (the start time of the monitoring)

A sample from a log file shown below.

```
2020/10/21 00:15:53 Port COM2
2020/10/21 00:15:53 Type: RS485
2020/10/21 00:15:53 Baud rate: 9600
2020/10/21 00:15:53 Data bits: 8
2020/10/21 00:15:53 Stop bit(s): 1
2020/10/21 00:15:53 Parity: None
2020/10/21 00:15:53 Mode: ASCII
2020/10/21 00:15:53 Modbus address: 1
2020/10/21 00:15:53 Protocol: Flowsic-600 US master
```

Time stamp: relative

```
00:00:01.048341 -> : 01 03 1B 59 00 14 74 CRLF
00:00:01.264502 <- : 01 03 50 45 16 00 00 45 AD 98 00 43 C8 00 00 41 20 00 00 43
C8 00 00 43 C8 00 00 43 C8 00 00 41 20 00 00 41 20 00 00 41 20 00 00
41 20 00 00 41 40 00 00 41 B8 00 00 42 08 00 00 42 34 00 00 42 60 00 00 42 86 00
00 42 9C 00 00 42 B2 00 00 35 CRLF
00:00:01.519248 -> : 01 03 13 89 00 0E 52 CRLF
00:00:01.680935 <- : 01 03 38 00 00 04 BC 00 00 0D 6A 00 00 16 18 00 00 04 BC 00
00 0D 6A 00 00 11 C1 00 00 00 00 00 00 00 00 00 00 00 00 85 3F 00 00 00 62
00 00 30 39 00 00 0C 00 00 03 E8 D0 CRLF
00:00:01.934626 -> : 01 03 0B B9 00 14 24 CRLF
00:00:02.061055 <- : 01 03 28 E2 40 00 00 02 00 00 00 00 00 00 00 00 00 0F 00
0F 00 0F 00 0F 00 20 00 21 00 22 00 23 00 24 00 25 00 26 00 27 00 02 56 CRLF
00:00:02.314019 -> : 01 03 1B 59 00 14 74 CRLF
00:00:02.530273 <- : 01 03 50 45 16 00 00 45 AD 98 00 43 C8 00 00 41 20 00 00 43
C8 00 00 43 C8 00 00 43 C8 00 00 41 20 00 00 41 20 00 00 41 20 00 00
```

41 20 00 00 41 40 00 00 41 B8 00 00 42 08 00 00 42 34 00 00 42 60 00 00 42 86 00
00 42 9C 00 00 42 B2 00 00 35 CRLF

9.4.8 Tests – Modbus TCP monitor

Route in the menu tree:



Entering the Modbus TCP monitor menu, a warning message will be displayed: “When using Modbus TCP monitor, ensure that only one client is polling the Modbus TCP port.”

Pressing OK, lead us to the setup data page.

Function of the F keys on the Tests – Modbus TCP port monitor data pages

↓ select the next field for editing

↑ select the previous field for editing

Change modify the selected data field

OK Confirm the selection

Start start monitoring the traffic on the Com port

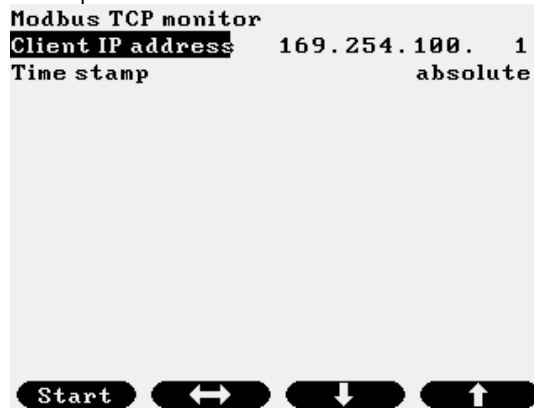

Figure 9-178 Tests – Modbus TCP port monitor, setup

The data fields on the data page are as follows:

- Client IP address;
Enter the IP address of the client which will poll the Modbus TCP port.
- Time stamp;
 - absolute; (real time clock time)
 - relative; (start of the monitoring is considered as zero time)
 - between messages; (time elapsed between messages is displayed)

After entering the Client IP address and timestamp format, the Start button leads us to the monitoring page.

The monitoring of the traffic, the scrolling on the display and the saving traffic data into log file identical with the items described for the Com port monitoring.

The log file name convention is as follows:

tcp_yyyy_mm_dd_hh_mm_ss.txt

where

yyyy_mm_dd_hh_mm_ss - is the time stamp (the start time of the monitoring)

A sample from a log file shown below.

```
2020/10/21 00:22:33 Host IP address: 169.254.100.4
2020/10/21 00:22:33 Client IP address: 169.254.100.1
2020/10/21 00:22:33 Modbus address: 1
2020/10/21 00:22:33 Reg. assignment: STD Modbus
```

Time stamp: relative

```

00:00:13.473768 <- 00 23 00 00 00 06 01 03 00 00 00 0c
00:00:13.473782 -> 00 23 00 00 00 1b 01 03 18 00 00 42 c8 7f ba c1 1d 00 00 41
70 4e 43 43 14 00 00 00 00 00 00 00
00:00:15.683761 <- 00 24 00 00 00 06 01 03 00 00 00 0c
00:00:15.683776 -> 00 24 00 00 00 1b 01 03 18 00 00 42 c8 7f ba c1 1d 00 00 41
70 4e 43 43 14 00 00 00 00 00 00 00
00:00:15.780244 <- 00 25 00 00 00 06 01 03 00 00 00 0c
00:00:15.780260 -> 00 25 00 00 00 1b 01 03 18 00 00 42 c8 7f ba c1 1d 00 00 41
70 4e 43 43 14 00 00 00 00 00 00 00
00:00:15.836403 <- 00 26 00 00 00 06 01 03 00 00 00 0c
00:00:15.836418 -> 00 26 00 00 00 1b 01 03 18 00 00 42 c8 7f ba c1 1d 00 00 41
70 4e 43 43 14 00 00 00 00 00 00 00
00:00:15.932940 <- 00 27 00 00 00 06 01 03 00 00 00 0c
00:00:15.932955 -> 00 27 00 00 00 1b 01 03 18 00 00 42 c8 7f ba c1 1d 00 00 41
70 4e 43 43 14 00 00 00 00 00 00 00
    
```

9.5 Calibration

The Calibration menu is reserved for factory use and for use in the laboratory of the authority calibrating the flow computer. It is accessible with special password only.

9.5.1 Rosemount 3095 calibration

If Rosemount 3095 multivariable transmitter with Modbus protocol is connected to Uniflow-200 on one of the serial link and the measured parameters (differential pressure, pressure, temperature) are assigned to one of the metering streams, then the calibration of this transmitter can be initiated here.

After entering the engineering level password the transmitter calibration display appears:

Route in the menu tree:

Calibration

Function of the F keys on the Calibration data page

↓ select the next field for editing

↑ select the previous field for editing

Change modify the selected data field

OK Confirm the selection

Menu returns to the parent menu

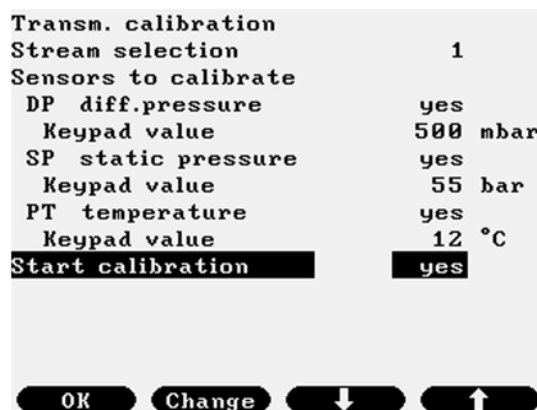

Figure 9-179 Transmitter calibration display

Select the stream in which the signals measured by the transmitter are used.

Select the sensors to be calibrated (DP, SP, PT) and enter the Keypad values. Keypad values will be used in the flow calculation during the calibration. Enter 0 keypad value for DP to stop the flow calculation during the calibration.

Change `Start calibration` field to `yes` and press OK.

Message box appears on the display requiring that the Write protection jumper to be set to OFF position. With jumper in ON position Uniflow-200 will not start the calibration. If the jumper is in OFF position then the sensor calibration page appears on display.

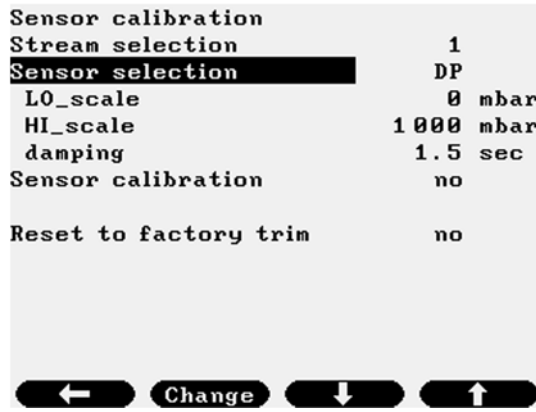

Figure 9-180 Sensor calibration display

Select the sensor (DP, SP, PT) to be calibrated. The LO scale, HI scale value for the selected sensor will be displayed as defined in the Modbus signal definition section. If you modify the LO scale or HI scale value here, the modified values will be written to the Modbus signal parameters. The damping parameter value is read from the transmitter. There is an option "Reset to factory trim" on the display, allowing to restore the sensor offset (zero) and slope (span) value to the factory default value.

To calibrate the selected sensor set the Sensor calibration command to yes and press OK. Message box appears requiring to apply LO scale value signal to sensor. The measured value of the signal is displayed in the message box.

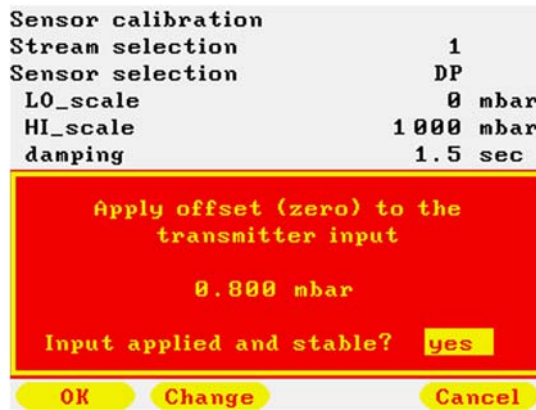

Figure 9-181 DP sensor offset calibration display

When the signal is applied and the reading is stable press OK. New message box appears confirming the successful setting of the transmitter offset.



Figure 9-182 DP sensor offset calibration finished display

New message box appears requiring to apply HI scale value signal to sensor. The measured value of the signal is displayed in the message box.

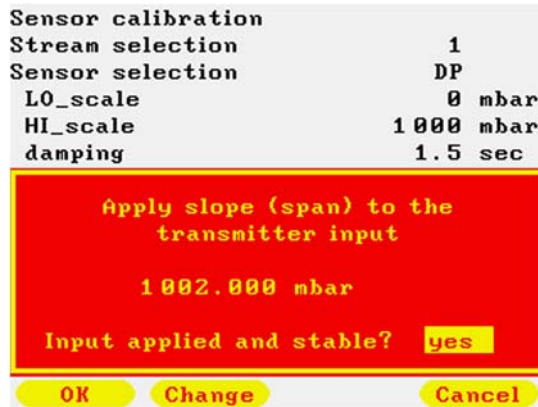

Figure 9-183 DP sensor slope calibration display

When the signal is applied and the reading is stable press OK. New message box appears confirming the successful setting of the transmitter slope (span).



Figure 9-184 DP sensor slope calibration finished display

In the next message box the value of the sensor damping can be entered and written into the transmitter.

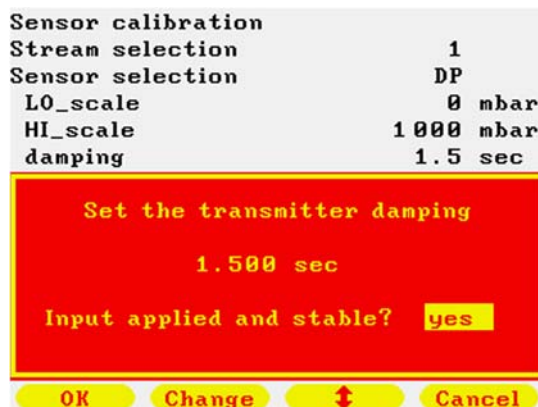

Figure 9-185 DP sensor damping display



Figure 9-186 DP sensor damping finished display

After the offset (zero), the slope (span) and the damping was successfully set message box appears indicating the end of sensor calibration.

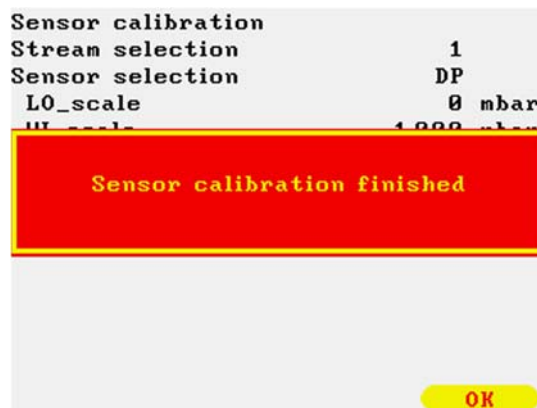

Figure 9-187 DP sensor calibration finished display

Repeat the above steps for the other sensors to be calibrated. After finishing the last sensor calibration message box appears indicating the end of calibration.

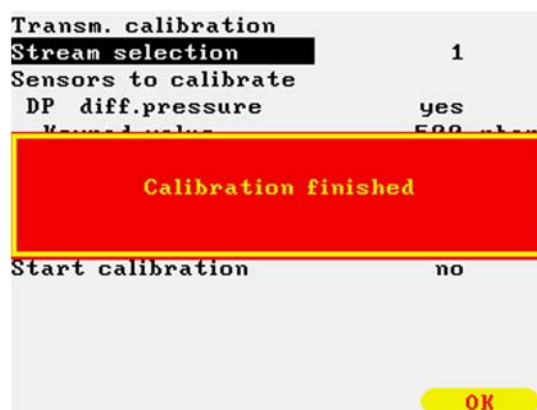

Figure 9-188 Calibration finished display

All the steps of the transmitter calibration are recorded in the Events archive.

9.6 Help

The contact details of the manufacturer (phone, fax, email address, website address) are available on this page.

9.7 Language/Nyelv/Язык/Limba

Route in the menu tree:

Main	Language/Nyelv/Язык/Limba.
------	----------------------------

Function of the F keys on the Language change data page

Change Modify the language

OK Confirm the selection

Menu Returns to the parent menu

This menu item is to change the working language of the flow computer.

Highlighting the menu item and pressing key ⇨ language change display opens.

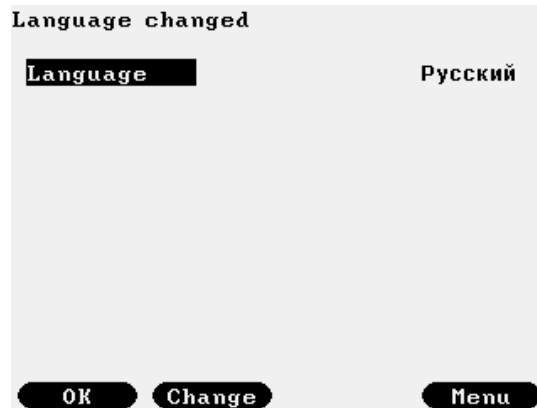

Figure 9-189 Language change display

Available languages are:

- English;
- Hungarian (Magyar);
- Russian (Русский)
- Român (Romanian)

After selecting the appropriate language and confirming the selection the flow computer completely changes the working language.

The language change will change to the appropriate language:

- display text;
- entries in the alarm and event log and archive records;
- text on the reports;

Changing the working language will not affect the operation of the flow computer. The setup made in one language remains valid after the other display language is selected.

CAUTION

The records made in the alarm and event log and in the archive record files before the changing of the language will not be changed to other language.

However, all the subsequent records will be done on the language activated.

It is recommended to make a general reset after the changing of the language setting. It will ensure to have single language records in the log files.

10 Communication

UNIFLOW-200 equipped with one 100 MHz Ethernet port and maximum of 8 serial communication ports (Com1 to Com8) allowing integration of the flow computer into data acquisition systems.

Port Com1 is on the CPU board, it always present.

Port Com2 and Com3 exists if SE serial extension module is installed.

Port Com4 to Com8 exists if CX5 serial extension board is installed.

UNIFLOW-200 is the slave device in the communication. It means that UNIFLOW-200 can be queried for data and it will respond if the queried registers are defined. Metering data can be read from UNIFLOW-200 flow computer via standard RS232, RS485, RS422 serial link and via 10/100 Ethernet link.

Communication protocols implemented:

Com1 to Com8 ports:	MODBUS over serial port
Ethernet port:	MODBUS over TCP

Modbus function codes implemented:

- 3 (0x03) read multiply registers
- 16 (0x10) write multiply registers

Port function of the serial port can be set to:

- STD Modbus slave RTU (2 bytes/register)
- STD Modbus slave ASCII (2 bytes/register)
- Daniel slave RTU (4 bytes/register)
- Daniel slave ASCII (4 bytes/register)

Port function for the serial port shall be set to STD Modbus slave to be able to read data listed in point 10.5 (including 10.5.1., 10.5.2. and 10.5.3.) in standard Modbus format.

Port function for the serial port shall be set to Daniel Modbus slave to be able to read data listed in point 10.6 (including 10.6.1., 10.6.2. and 10.6.3.) in Daniel/Omni/Enron Modbus format.

Register assignment for Ethernet port shall be set to STD MODBUS to be able to read data listed in point 10.5 (including 10.5.1., 10.5.2. and 10.5.3.) in standard Modbus format.

Register assignment for Ethernet port shall be set to Daniel to be able to read data listed in point 10.6 (including 10.6.1., 10.6.2. and 10.6.3.) in Daniel/Omni/Enron Modbus format.

Port function on any serial or Ethernet port can be set to User Modbus. In this case data defined in the User Modbus table can be accessed via port. See details of the User Modbus in Annex C.

Special functions implemented for polling ultrasonic flow meters:

- Caldon US master (for Caldon ultrasonic meters)
- Daniel US master (for Daniel ultrasonic meters)
- Flexim US master (for Flexim ultrasonic meters)
- Flowsic-600 master (for Sick-Maihak Flowsic-600 ultrasonic meter)
- Flowsic-600XT master (for Sick-Maihak Flowsic-600XT ultrasonic meter)
- Khrono US master (for Khrono ultrasonic meters)
- Panam US master (for Panametrics ultrasonic meters)
- QSonic US Uniform (for Instromet ultrasonic meters with Uniform protocol)
- QSonicPlus US master (for Instromet ultrasonic meters with Modbus protocol)
- RMA US master (for RMA ultrasonic meters)
- RMG US master (for RMG ultrasonic meters)
- Siemens US master (for Siemens ultrasonic meters)
- FMC MPU Series B (for FMC ultrasonic meters)

In this special functions not only the flow information (flow rate and/or gas velocity) but the diagnostic information is read from the meters as well.

Special functions implemented for polling gas chromatographs:

- ABB GC master (for ABB GC)
- ABB2 GC master (for ABB GC)
- Daniel C6+ GC master (for Daniel C6+ GC)
- Daniel C9+ GC master (for Daniel C9+ GC)

- Yamatake GC master (for Yamatake GC)
- Yokogawa GC master (for Yokogawa GC)
- EnCal3000 GC master (for Elster EnCal300 GC)

If one of the com ports is configured for chromatograph polling then UNIFLOW-200 will read the natural gas composition from the gas chromatograph and the gas composition will be used in the gas properties calculation. See 9.2.2.1.1.1. and 9.2.4.1.

The serial ports and the USB port can be used as printer port to transfer the archive data to external device (file dumping to serial printer, serial port of PC or USB flash drive). See details in 9.1.5.

The archive data files sent to the serial or USB port make use of UTF8 encoding. To display the archive data file on external device it shall be set accordingly. Otherwise, some of the characters on the reports might not be displayed properly.

10.1 Serial link setup

The parameters of the serial link are setup in the Parameters/Interfaces/Com ports menu.

After selecting the port to be configured the type (RS232, RS485, RS422) is set together with the data flow parameters (data bits, stop bits, parity, etc.). Then the mode of communication is selected (STD Modbus, Daniel Modbus or User Modbus, RTU or ASCII). Finally, the device address shall be set.

If the port type RS485 or RS422MD is set then the response delay can also be set. The default value is 1 ms which is suitable in most of the case but can be modified if required.

In case of RS232 and RS422PP port type the response, delay cannot be set.

10.2 Ethernet link setup

The parameters of the Ethernet link are setup in the Parameters/Interfaces/Ethernet menu.

The IP address, the subnet mask and the default gateway should be set together with the Modbus device address.

The register mode can be set to STD Modbus, Daniel Modbus or User Modbus.

The protocol implemented is MODBUS over TCP.

The flow computer is capable to act as DHCP server if configured so.

10.3 Communication device address

If Daniel Modbus slave RTU or Daniel Modbus slave ASCII mode is selected then there are two ways to read the metering data from the flow computer for all 12 metering streams (8 physical and 4 virtual streams).

All data for all streams can be read on the base device address set in the com port setup menu.

At the same time all metering stream have its own device address and the metering data for a particular stream can be read on this particular device address.

The register address ranges and the device addresses are shown in the table below.

Stream	Registers on the base device address		Stream device address	Registers on the stream device address	
	Totals (4 bytes integer)	Other data (4 bytes float)		Totals (4 bytes integer)	Other data (4 bytes float)
1	5001 - 5148	7001 - 7099	base device address	5001 - 5148	7001 - 7099
2	5201 - 5348	7101 - 7199	base device address + 1	5001 - 5148	7001 - 7099
3	5401 - 5548	7201 - 7299	base device address + 2	5001 - 5148	7001 - 7099
4	5601 - 5748	7301 - 7399	base device address + 3	5001 - 5148	7001 - 7099
5	5801 - 5948	7401 - 7499	base device address + 4	5001 - 5148	7001 - 7099
6	6001 - 6148	7501 - 7599	base device address + 5	5001 - 5148	7001 - 7099
7	6201 - 6348	7601 - 7699	base device address + 6	5001 - 5148	7001 - 7099

8	6401 - 6548	7701 - 7799	base device address + 7	5001 - 5148	7001 - 7099
9	9001 - 9148	8001 - 8099	base device address + 8	5001 - 5148	7001 - 7099
10	9201 - 9348	8101 - 8199	base device address + 9	5001 - 5148	7001 - 7099
11	9401 - 9548	8201 - 8299	base device address + 10	5001 - 5148	7001 - 7099
12	9601 - 9748	8301 - 8399	base device address + 11	5001 - 5148	7001 - 7099

Table 10-16 Communication device addresses

NOTE

In Daniel Modbus slave mode one UNIFLOW-200 occupies 12 consecutive device addresses. If other devices connected to the serial link (e.g. on RS485 bus) the setting of the device addresses should take it into consideration.

10.4 Protocol implementation

10.4.1 Implemented Modbus command codes

10.4.1.1 Read multiply registers (code: 3)

Query:

A	F	RAH	RAL	RNH	RNL	CH	CL
---	---	-----	-----	-----	-----	----	----

Response:

A	F	BN	D1	...	Dn	CH	CL
---	---	----	----	-----	----	----	----

10.4.1.2 Write multiply registers (code: 16)

Query:

A	F	RAH	RAL	RNH	RNL	BN	D1	...	CH	CL
---	---	-----	-----	-----	-----	----	----	-----	----	----

Response:

A	F	RAH	RAL	RNH	RNL	CH	CL
---	---	-----	-----	-----	-----	----	----

where:

- A - device address
- F - function code
- RAH, RAL - starting register address, in high byte, low byte order
- RNH, RNL - number of registers, in high byte, low byte order
- BN - number of bytes (from 0 to 255)
- D1 ... Dn - data bytes, $n = 2 * \text{number of registers}$
- CH, CL - CRC check sum, in high byte, low byte order

Examples

Read stream 6 instantaneous flow data and alarm registers (18 registers) from the flow computer with device address 17 (0x11)

Query

device address	function code	starting register (high byte)	starting register (low byte)	number of register (high byte)	number of register (low byte)	checksum (2 bytes)
0x11	0x03	0x01	0x2c	0x00	0x12	CRC

Response

device address	function code	number of bytes	data bytes (36 bytes)	checksum (2 bytes)
0x11	0x03	0x30	...	CRC

Write zero to the first 4 gas component concentration register

Query

device address	function code	starting register (high byte)	starting register (low byte)	number of register (high byte)	number of register (low byte)	byte count (1 byte)	data (16 bytes)	checksum (2 bytes)
0x11	0x10	0x03	0x32	0x00	0x08	0x10	...	CRC

Response

device address	function code	starting register (high byte)	starting register (low byte)	number of register (high byte)	number of register (low byte)	checksum (2 bytes)
0x11	0x10	0x03	0x32	0x00	0x08	CRC

10.4.2 Calculation of CRC check sum

The polynomial value used in CRC calculation is 0xa001.

CRC is calculated in steps as follows:

1. Load a 16-bit register with 0xffff hex (all 1's). Call this the CRC register.
2. Exclusive OR the first 8-bit byte of the message with the high-order byte of the 16-bit CRC register, putting the result in the CRC register.
3. Shift the CRC register one bit to the right (toward the LSB), zero-filling the MSB. Extract and examine the LSB.
4. (If the LSB was 0): Repeat Step 3 (another shift).
5. (If the LSB was 1): Exclusive OR the CRC register with the polynomial value A001 hex (1010 0000 0000 0001).
6. Repeat Steps 3 and 4 until 8 shifts have been performed. When this is done, a complete 8-bit byte will have been processed.
7. Repeat the steps 2 to 6 with the next byte of the message until all the bytes are processed.
8. The result is the CRC of the message.

10.4.3 Data types in the Modbus registers

10.4.3.1 8 bit binary unsigned integer

They are stored in the low order or high order byte of the Modbus registers.

Range: from 0 to 255 (0x00 to 0xff)

Data stored in this form are the parts of the date for example.

In some cases bits of this data type have separate interpretation for example in alarm registers.

10.4.3.2 16 bit binary unsigned integer

They are stored in the Modbus registers.

Range: from 0 to 65535 (0x0000 to 0xffff)

10.4.3.3 32 bit binary signed integer

They are stored in two Modbus registers.

Range: from -2 147 483 648 to 2 147 483 648 (0x0000 to 0x7fffffff positive numbers and 0x80000000 to 0xffffffff negative numbers)

Numbers are stored as follows:

31	30	0	
S	absolute value of the number		
High byte		Low byte + 2	Low byte + 1
low order Modbus register		high order Modbus register	

The S sign bit is 0 if the number is positive and 1 if the number is negative.

As far as number is stored not in 2's complements form both +0 and -0 are valid.

10.4.3.4 Floating point number

Most of the data are stored in floating point format.

The format used in the flow computer for floating point number is equivalent to the IEEE 754/1985 Short real (single precision) format.

Numbers are stored in three parts: sign, exponent and mantissa on four bytes. Floating point numbers are stored in two Modbus registers.

Range: +/- (8.43*10⁻³⁷ ... 3.4*10⁻³⁸), and the numbers are accurate up to 7 decimal digits.

Numbers are stored as follows:

31	30	23	22	0
S	Exponent		Mantissa	
High byte		Low byte	High byte	Low byte
High order Modbus register			Low order Modbus register	

The S sign bit is 0 if the number is positive and 1 if the number is negative.

As far as number is stored not in 2's complements form both +0 and -0 are valid.

-0 is not interpreted as number. It is used for special purposes in the flow computer.

Mantissa is stored in normalized form without the most significant bit which is always 1. It means that the 22nd bit is 2⁻¹, the 21st bit is 2⁻² and the 0. bit is 2⁻²³

The exponent field holds the exponent value biased by 127. The bias provides that the exponent field is always positive. The range of the exponent is from -126 to +127.

Floating point number = (-1)^S * (1 + bit₂₂*2⁻¹ + bit₂₁*2⁻² + ... + bit₀*2⁻²³) * 2^{Exponent-127}

10.5 Standard Modbus register map (2 byte/register)

Modbus register	Register type	Description	Comment
0	ReadOnly	Str1. (physical stream) data	60 reg./stream
...	ReadOnly	...	
420	ReadOnly	Str8. (physical stream) data	

Offset address	Physical stream data	Explanation	
0-1	pressure	(32 bit floating)	
2-3	temperature1 (fluid/forward)	(32 bit floating)	
4-5	temperature2 (ambient/reverse)	(32 bit floating)	
6-7	density at line conditions	(32 bit floating)	
8-13	1-6. alarm register (16 bit int.)	alarm code (H byte)	signal code (L byte)
		0. bit: LO_range	temperature1 : 0
		1. bit: HI_range	temperature2 : 1
		2. bit: LO_limit	pressure: 2
		3. bit: HI_limit	diff.pressure: 3
		4. bit: cut-off	density: 6
			flow signal: 7
14	7. alarm register	FF (H)	FF (L)
15	8. alarm register	temp. fluid (H byte)	temp. ambient (L byte)
16	9. alarm register	density (H byte)	pressure (L byte)
		0. bit: LO_range	0. bit: LO_range
		1. bit: HI_range	1. bit: HI_range
		2. bit: LO_limit	2. bit: LO_limit
		3. bit: HI_limit	3. bit: HI_limit
		4. bit: LOLO_limit	4. bit: LOLO_limit
		5. bit: HIHI_limit	5. bit: HIHI_limit
		6. bit: active	6. bit: active
		7. bit: valid	7. bit: valid
17	10. alarm register	stream (H byte)	flow signal (L byte)
		0. bit: range	0. bit: LO_range
		1. bit: composition	1. bit: HI_range
		2. bit: method	2. bit: LO_limit
		3. bit: check	3. bit: HI_limit
		4. bit: quantity	4. bit: LOLO_limit
		5. bit: dp/p ratio	5. bit: HIHI_limit
		6. bit: cut-off	6. bit: active
		7. bit: valid	7. bit: valid
18-19	volume at base conditions (CVOL) flowrate	(32 bit floating)	
20-21	mass flowrate	(32 bit floating)	
22-23	energy flowrate	(32 bit floating)	
24-25	volume at base conditions (CVOL) cumulative total	(32 bit floating) rollover at 10 000 000	
26-27	mass cumulative total	(32 bit floating) rollover at 10 000 000	
28-29	energy cumulative total	(32 bit floating) rollover at 10 000 000	
30-31	base density	(32 bit floating)	
32-33	relative density	(32 bit floating)	
34-35	gross calorific value	(32 bit floating)	
36-37	volume at line conditions (UVOL) cumulative total	(32 bit floating) rollover at 10 000 000	
38-29	fault mass cumulative total	(32 bit floating) rollover at 10 000 000	
40-41	fault energy cumulative total	(32 bit floating) rollover at 10 000 000	
42-43	premium volume cumulative total	rollover at 10 000 000	
44-45	premium mass cumulative total	rollover at 10 000 000	
46-47	premium energy cumulative total	rollover at 10 000 000	

480	ReadOnly	Str9. (virtual stream) data	(32 bit floating)	42 reg./stream
...	ReadOnly	...		
606	ReadOnly	Str12. (virtual stream) data		

Offset address	Virtual stream data	Explanation
0-1	volume at base conditions (CVOL) flowrate	
2-3	mass flowrate	
4-5	energy flowrate	
6-7	volume at base conditions (CVOL) cumulative total	rollover at 10 000 000
8-9	mass cumulative total	rollover at 10 000 000
10-11	energy cumulative total	rollover at 10 000 000
24-25	prem. volume cumulative tot.	rollover at 10 000 000
26-27	prem. mass cumulative total	rollover at 10 000 000
28-29	prem. energy cumulative total	rollover at 10 000 000

648	ReadOnly	Flow rates	(32 bit floating)	72 reg./stream
-----	----------	------------	-------------------	----------------

Offset address	Stream flowrates (for quick access)	Explanation
0-1	Str1. volume at base conditions (CVOL) flowrate	
2-3	Str1. mass flowrate	
4-5	Str1. energy flowrate	
...	...	
66-67	Str12. volume at base conditions (CVOL) flowrate	
68-69	Str12. mass flowrate	
70-71	Str12. energy flowrate	

816-817	ReadWrite	Barometric pressure	(32 bit floating)	2 register
---------	-----------	---------------------	-------------------	------------

818	ReadWrite	Natural gas components	(32 bit floating)	44 register
-----	-----------	------------------------	-------------------	-------------

Offset address	Natural gas components	Explanation
0-1	Nitrogen [mole%]	If the source of gas composition selected as Modbus STD1 then gas composition downloaded into this register range will be used in the calculation.
2-3	Carbon-dioxide [mole%]	
4-5	Hydrogen-sulfide [mole%]	The range is common for all streams from 1 to 8
6-7	Water [mole%]	
8-9	Helium [mole%]	
10-11	Methane [mole%]	
12-13	Ethane [mole%]	
14-15	Propane [mole%]	
16-17	normal-Butane [mole%]	
18-19	iso-Butane [mole%]	
20-21	normal-Pentane [mole%]	
22-23	iso-Pentane [mole%]	
24-25	normal-Hexane [mole%]	
26-27	normal-Heptane [mole%]	
28-29	normal-Octane [mole%]	
30-31	normal-Nonane [mole%]	
32-33	normal-Decane [mole%]	
34-35	Oxygen [mole%]	
36-37	Carbon-monoxide [mole%]	
38-39	Hydrogen [mole%]	
40-41	Relative density [-]	
42-43	Inferior calorific value [MJ/m ³]	

862	ReadWrite	timeout counter register *		1 register (16 bit integer)
-----	-----------	----------------------------	--	-----------------------------

* When the timeout counter value exceeds the update timeout it causes an update timeout alarm. In this alarm condition the component data will be substituted with its keypad value in the subsequent calculations. The register block update automatically clears its own timeout counter register to zero.

863	ReadWrite	Date and time		5 register
-----	-----------	---------------	--	------------

Offset address	Time	Explanation	
0	alarm, second (0-59)	second alarm (H)	second (L)
1	alarm, minute (0-59)	minute alarm (H)	minute (L)
2	alarm, hour (0-23)	hour alarm (H)	hour (L)
3	day (1-31), week day (1-7)	day of month (H)	day of week (L)
4	year (0-99), month (1-12)	year (H)	month (L)

870	ReadWrite	Natural gas components - 1 th stream	(32 bit floating)	54 register
.....	ReadWrite			
1248	ReadWrite	Natural gas components - 8 th stream		

Offset address	Natural gas components	Explanation	Modbus STD2
0-1	Superior calorific value	If the source of gas composition selected	
2-3	Argon, mole%	as Modbus STD2 then gas composition	
4-5	Line density	downloaded into this register range will be	
6-7	Base density	used in the calculation.	
8-9	Nitrogen [mole%]	There are separate address range for each	
10-11	Carbon-dioxide [mole%]	of the streams to download the gas	
12-13	Hydrogen-sulfide [mole%]	composition.	
14-15	Water [mole%]		
16-17	Helium [mole%]		
18-19	Methane [mole%]		
20-21	Ethane [mole%]		
22-23	Propane [mole%]		
24-25	normal-Butane [mole%]		
26-27	iso-Butane [mole%]		
28-29	normal-Pentane [mole%]		
30-31	iso-Pentane [mole%]		
32-33	normal-Hexane [mole%]		
34-35	normal-Heptane [mole%]		
36-37	normal-Octane [mole%]		
38-39	normal-Nonane [mole%]		
40-41	normal-Decane [mole%]		
42-43	Oxygen [mole%]		
44-45	Carbon-monoxide [mole%]		
46-47	Hydrogen [mole%]		
48-49	Relative density [-]		
50-51	Inferior calorific value		
52	timeout counter register *		1 register (integer)
53	-		

* When the timeout counter value exceeds the update timeout it causes an update timeout alarm. In this alarm condition the component data will be substituted with its keypad value in the subsequent calculations. The register block update automatically clears its own timeout counter register to zero.

The unit of densities and calorific values depends on the selection of metric or imperial units (see the chapter 9.2.2.1)

	METRIC UNIT	IMPERIAL UNIT
gas components	mole %	mole%
line density	kg/m ³	lbs/CF
base density	kg/m ³	lbs/CF
relative density	-	-
calorific value	MJ/m ³	BTU/SCF

1844	ReadOnly	(IO1 Ch1) analog input	(32 bit floating)	3 reg./channel
...	ReadOnly	...		
1865	ReadOnly	(IO1 Ch8) analog input		
1868	ReadOnly	(IO2 Ch1) analog input		
...	ReadOnly	...		
1889	ReadOnly	(IO2 Ch2) analog input		
1892	ReadOnly	(IO3 Ch1) analog input		
...	ReadOnly	...		
1913	ReadOnly	(IO3 Ch8) analog input		
1916	ReadOnly	(IO4 Ch1) analog input		
...	ReadOnly	...		
1937	ReadOnly	(IO4 Ch8) analog input		

Offset address	Analog input signals (Quick access)	Explanation	
0	state, alarm	state (H)	alarm state (L)
			0. bit: LO_range
			1. bit: HI_range
			2. bit: LO_limit
			3. bit: HI_limit
			4. bit: LOLO_limit
			5. bit: HIHI_limit
			6. bit: active
			7. bit: valid
1-2	measured data		

2004	ReadOnly	Totals grouped together	(32 bit signed integer numbers)	72 reg.
------	----------	-------------------------	---------------------------------	---------

2004	ReadOnly	Str1. (physical stream) totals		6 reg./stream
2010	ReadOnly	Str2. (physical stream) totals		
2016	ReadOnly	Str3. (physical stream) totals		
2022	ReadOnly	Str4. (physical stream) totals		
2028	ReadOnly	Str5. (physical stream) totals		
2034	ReadOnly	Str6. (physical stream) totals		
2040	ReadOnly	Str7. (physical stream) totals		
2046	ReadOnly	Str8. (physical stream) totals		
2052	ReadOnly	Str9. (virtual stream) totals		
2058	ReadOnly	Str10. (virtual stream) totals		
2064	ReadOnly	Str11. (virtual stream) totals		
2070	ReadOnly	Str12. (virtual stream) totals		

Offset address	Physical streams total	Explanation	
0-1	volume at base conditions (CVOL) cumulative total	rollover at 1 000 000 000	2 reg.
2-3	mass cumulative total	rollover at 1 000 000 000	
4-5	energy cumulative total	rollover at 1 000 000 000	

2076	ReadOnly	Str1. (physical stream) volume at line conditions (UVOL) total	(32 bit signed integer numbers)	72 reg. 2 reg./stream
2078	ReadOnly	Str2. (physical stream) volume at line conditions (UVOL) total		
2080	ReadOnly	Str3. (physical stream) volume at line conditions (UVOL) total		
2082	ReadOnly	Str4. (physical stream) volume at line conditions (UVOL) total		
2084	ReadOnly	Str5. (physical stream) volume at line conditions (UVOL) total		
2086	ReadOnly	Str6. (physical stream) volume at line conditions (UVOL) total		

2088	ReadOnly	Str7. (physical stream) volume at line conditions (UVOL) total	
2090	ReadOnly	Str8. (physical stream) volume at line conditions (UVOL) total	

Offset address	Physical streams total	Explanation
0-1	volume at line conditions (UVOL) cumulative total	rollover at 1 000 000 000 2 reg.

2100	ReadOnly	(IO1 Ch1) analog input	(32 bit floating)	3 reg./channel
...	ReadOnly	...		
2121	ReadOnly	(IO1 Ch8) analog input		
2124	ReadOnly	(IO2 Ch1) analog input		
...	ReadOnly	...		
2145	ReadOnly	(IO2 Ch8) analog input		
2148	ReadOnly	(IO3 Ch1) analog input		
...	ReadOnly	...		
2169	ReadOnly	(IO3 Ch8) analog input		
2172	ReadOnly	(IO4 Ch1) analog input		
...	ReadOnly	...		
2193	ReadOnly	(IO4 Ch8) analog input		
2196	ReadOnly	(IO5 Ch1) analog input		
...	ReadOnly	...		
2217	ReadOnly	(IO5 Ch8) analog input		

2220	ReadOnly	(IO1 Ch9) analog input		3 reg./channel
...	ReadOnly	...		
2241	ReadOnly	(IO1 Ch16) analog input		
2244	ReadOnly	(IO2 Ch9) analog input		
...	ReadOnly	...		
2265	ReadOnly	(IO2 Ch16) analog input		
2268	ReadOnly	(IO3 Ch9) analog input		
...	ReadOnly	...		
2289	ReadOnly	(IO3 Ch16) analog input		
2292	ReadOnly	(IO4 Ch9) analog input		
...	ReadOnly	...		
2313	ReadOnly	(IO4 Ch16) analog input		
2316	ReadOnly	(IO5 Ch9) analog input		
...	ReadOnly	...		
2337	ReadOnly	(IO5 Ch16) analog input		

2340	ReadOnly	(IO1 Ch17) analog input		3 reg./channel
...	ReadOnly	...		
2361	ReadOnly	(IO1 Ch24) analog input		
2364	ReadOnly	(IO2 Ch17) analog input		
...	ReadOnly	...		
2385	ReadOnly	(IO2 Ch24) analog input		
2388	ReadOnly	(IO3 Ch17) analog input		
...	ReadOnly	...		
2409	ReadOnly	(IO3 Ch24) analog input		
2412	ReadOnly	(IO4 Ch17) analog input		
...	ReadOnly	...		
2433	ReadOnly	(IO4 Ch24) analog input		
2436	ReadOnly	(IO5 Ch17) analog input		
...	ReadOnly	...		
2457	ReadOnly	(IO5 Ch24) analog input		

2460	ReadOnly	(IO1 Ch25) analog input		3 reg./channel
...	ReadOnly	...		
2481	ReadOnly	(IO1 Ch32) analog input		
2484	ReadOnly	(IO2 Ch25) analog input		
...	ReadOnly	...		
2505	ReadOnly	(IO2 Ch32) analog input		
2508	ReadOnly	(IO3 Ch25) analog input		
...	ReadOnly	...		
2529	ReadOnly	(IO3 Ch32) analog input		
2532	ReadOnly	(IO4 Ch25) analog input		
...	ReadOnly	...		
2553	ReadOnly	(IO4 Ch32) analog input		
2556	ReadOnly	(IO5 Ch25) analog input		

...	ReadOnly	...	
2577	ReadOnly	(IO5 Ch32) analog input	
2580	ReadWrite	Ch1 Modbus analog input	3 reg./channel
...	ReadWrite	...	
2667	ReadWrite	Ch30 Modbus analog input	

Offset Address	Analog input signals (Quick access)	Explanation	
0	state, alarms	state (H) 0. bit = 1 (ch in alarm)	alarm state (L) 0. bit: LO_range 1. bit: HI_range 2. bit: LO_limit 3. bit: HI_limit 4. bit: LOLO_limit 5. bit: HHHI_limit 6. bit: active 7. bit: valid
1-2	measured data		(32 bit float)

2670	ReadOnly	IO1 digital inputs	2 reg./IO
2672	ReadOnly	IO2 digital inputs	
2674	ReadOnly	IO3 digital inputs	
2676	ReadOnly	IO4 digital inputs	
2678	ReadOnly	IO5 digital inputs	

Offset Address	Digital input signal	Explanation
0	Status (16 bit)	1 bit / channel (1 = active, 0=inactive) (1-16. channel, 1. channel. = 0. bit)
1	Value (16 bit)	1 bit / channel (0=open, 1=closed) (1-16. channel., 1. channel. = 0. bit)

2680	ReadOnly	IO1 digital outputs	2 reg./IO
2682	ReadOnly	IO2 digital outputs	
2684	ReadOnly	IO3 digital outputs	
2686	ReadOnly	IO4 digital outputs	
2688	ReadOnly	IO5 digital outputs	

Offset Address	Digital input signal	Explanation
0	Status (16 bit)	1 bit / channel (1 = active, 0=inactive) (1-16. channel, 1. channel. = 0. bit)
1	Value (16 bit)	1 bit / channel (0=open, 1=closed) (1-16. channel., 1. channel. = 0. bit)

2700	ReadOnly	Volume at line conditions (UVOL) flowrate (US flow meter on Com1 port	(32 bit float)	2 reg.
2702	ReadOnly	Com1 port, timeout counter register *		2 reg.
2708	ReadOnly	Volume at line conditions (UVOL) flowrate (US flow meter on Com2 port		2 reg.
2710	ReadOnly	Com2 port, timeout counter register *		2 reg.
2716	ReadOnly	Volume at line conditions (UVOL) flowrate (US flow meter on Com3 port		2 reg.
2718	ReadOnly	Com3 port, timeout counter register *		2 reg.
2720	ReadOnly	Volume at line conditions (UVOL) flowrate (US flow meter on Com4 port		2 reg.
2722	ReadOnly	Com4 port, timeout counter register *		2 reg.
2724	ReadOnly	Volume at line conditions (UVOL) flowrate (US flow meter on Com5 port		2 reg.
2726	ReadOnly	Com5 port, timeout counter register *		2 reg.
2728	ReadOnly	Volume at line conditions (UVOL) flowrate (US flow meter on Com6 port		2 reg.
2730	ReadOnly	Com6 port, timeout counter register *		2 reg.
2732	ReadOnly	Volume at line conditions (UVOL) flowrate (US flow meter on Com7 port		2 reg.
2734	ReadOnly	Com7 port, timeout counter register *		2 reg.
2736	ReadOnly	Volume at line conditions (UVOL) flowrate (US flow meter on Com8 port		2 reg.
2738	ReadOnly	Com8 port, timeout counter register *		2 reg.

2830	ReadOnly	(IO1 Ch1) analog output		3 reg./channel
...	ReadOnly	...		
2839	ReadOnly	(IO1 Ch4) analog output		
2842	ReadOnly	(IO2 Ch1) analog output		
...	ReadOnly	...		
2851	ReadOnly	(IO2 Ch4) analog output		
2854	ReadOnly	(IO3 Ch1) analog output		
...	ReadOnly	...		
2863	ReadOnly	(IO3 Ch4) analog output		
2866	ReadOnly	(IO4 Ch1) analog output		
...	ReadOnly	...		
2875	ReadOnly	(IO4 Ch4) analog output		
2878	ReadOnly	(IO5 Ch1) analog output		
...	ReadOnly	...		
2887	ReadOnly	(IO5 Ch4) analog output		

Offset Address	Analog output signals	Explanation	
0	state, alarms	state (H)	alarm state (L)
		0. bit = 1 (ch in alarm)	0. bit: LO_range
			1. bit: HI_range
			2. bit: LO_limit
			3. bit: HI_limit
			4. bit: LOLO_limit
			5. bit: HIHI_limit
			6. bit: active
			7. bit: valid
1-2	measured data	(32 bit float)	

CO2 emission data block, total length 176 Modbus registers

3000	ReadOnly	Str1. CO2 emission	(32 bit float)	22 reg./stream
3022	ReadOnly	Str2. CO2 emission		
3044	ReadOnly	Str3. CO2 emission		
3066	ReadOnly	Str4. CO2 emission		
3088	ReadOnly	Str5. CO2 emission		
3110	ReadOnly	Str6. CO2 emission		
3132	ReadOnly	Str7. CO2 emission		
3154	ReadOnly	Str8. CO2 emission		

Offset address	CO2 emission data by streams	Explanation
0-1	Specific carbon content	(32 bit float)
2-3	CO2 emission mass flowrate (instantaneous)	(32 bit float)
4-5	CO2 emission, cumulative mass total	(32 bit integer)
6-7	CO2 emission, previous hour mass total	(32 bit integer)
10-11	CO2 emission, previous day mass total	(32 bit integer)
12-13	CO2 emission, previous month mass total	(32 bit integer)
14-15	CO2 emission, current hour mass total	(32 bit integer)
16-17	CO2 emission, current day mass total	(32 bit integer)
20-21	CO2 emission, current month mass total	(32 bit integer)

General purpose register block, total length 120 Modbus registers

4000	ReadWrite	1. variable	(32 bit float)	2+2 reg./variable
4002	ReadWrite	2. variable		
...		...		
4058	ReadWrite	30. variable		
4060	ReadWrite	1. variable timeout counter register *		
4062	ReadWrite	2. variable timeout counter register *		
...				
4118	ReadWrite	3. variable timeout counter register *		

* When the timeout counter value of any particular Modbus signal exceeds the update timeout of that signal it causes an update timeout alarm. In this alarm condition if the Modbus signal is flow signal it will be substituted with zero (0), i.e. zero flow is assumed. If the Modbus signal is not flow signal it will be substituted with its keypad value in the subsequent calculations. Register update of a variable automatically clears its own timeout counter register to zero.

9800	ReadOnly	Ethanol concentrations	(32 bit floating)	32 reg.
------	----------	------------------------	-------------------	---------

9800	ReadOnly	Str1. (physical stream) concentrations		4 reg./stream
9804	ReadOnly	Str2. (physical stream) concentrations		
9808	ReadOnly	Str3. (physical stream) concentrations		
9812	ReadOnly	Str4. (physical stream) concentrations		
9816	ReadOnly	Str5. (physical stream) concentrations		
9820	ReadOnly	Str6. (physical stream) concentrations		
9824	ReadOnly	Str7. (physical stream) concentrations		
9828	ReadOnly	Str8. (physical stream) concentrations		

Offset address	Physical streams total	Explanation
0-1	concentration v/v %	2 reg.
3-4	concentration m/m %	2 reg.

10.5.1 Accessing periodic totals

UNIFLOW-200 supports the reading of the periodic totals in one message for each stream separately in this register mode. All the periodic totals (120 registers) must be read in one message. Reading part of the totals is not supported.

The starting address of the periodic totals for stream n. calculated as follows:

Starting address = 20 000 + 256 * (stream number – 1)

The total length of the data bytes in the response is 240 bytes (60 totals in floating point format, i.e. 120 Modbus registers).

20000	ReadOnly	Str1. periodic totals	120 reg./stream
20256	ReadOnly	Str2. periodic totals	
20512	ReadOnly	Str3. periodic totals	
20768	ReadOnly	Str4. periodic totals	
21024	ReadOnly	Str5. periodic totals	
21280	ReadOnly	Str6. periodic totals	
21536	ReadOnly	Str7. periodic totals	
21792	ReadOnly	Str8. periodic totals	
22048	ReadOnly	Str9. periodic totals	
22304	ReadOnly	Str10. periodic totals	
22560	ReadOnly	Str11. periodic totals	
22816	ReadOnly	Str12. periodic totals	

Offset address	Stream periodic totals (Arch1)	Explanation
0-1	volume at base conditions (CVOL), previous hour	
2-3	volume at base conditions (CVOL), previous 8 hour	
4-5	volume at base conditions (CVOL), previous day	
6-7	volume at base conditions (CVOL), previous month	
10-11	volume at base conditions (CVOL), current hour	
12-13	volume at base conditions (CVOL), current 8 hour	
14-15	volume at base conditions (CVOL), current day	
16-17	volume at base conditions (CVOL), current month	
20-21	mass, previous hour	
22-23	mass, previous 8 hour	
24-25	mass, previous day	
26-27	mass, previous month	
30-31	mass, current hour	
32-33	mass, current 8 hour	
34-35	mass, current day	
36-37	mass, current month	
40-41	energy, previous hour	
42-43	energy, previous 8 hour	
44-45	energy, previous day	
46-47	energy, previous month	
50-51	energy, current hour	
52-53	energy, current 8 hour	
54-55	energy, current day	
56-57	energy, current month	
60-61	premium volume at base conditions (CVOL), previous hour	
62-63	premium volume at base conditions (CVOL), previous 8 hour	

64-65	premium volume at base conditions (CVOL), previous day	
66-67	premium volume at base conditions (CVOL), previous month	
70-71	premium volume at base conditions (CVOL), current hour	
72-73	premium volume at base conditions (CVOL), current 8 hour	
74-75	premium volume at base conditions (CVOL), current day	
76-77	premium volume at base conditions (CVOL), current month	
80-81	premium mass, previous hour	
82-83	premium mass, previous 8 hour	
84-85	premium mass, previous day	
86-87	premium mass, previous month	
90-91	premium mass, current hour	
92-93	premium mass, current 8 hour	
94-95	premium mass, current day	
96-97	premium mass, current month	
100-101	premium energy, previous hour	
102-103	premium energy, previous 8 hour	
104-105	premium energy, previous day	
106-107	premium energy, previous month	
110-111	premium energy, current hour	
112-113	premium energy, current 8 hour	
114-115	premium energy, current day	
116-117	premium energy, current month	

Unit of measurement for the quantities listed in tables above:

	METRIC UNIT	IMPERIAL UNIT (only in case of natural gas measuring)
mass	kg (t)*	lb
mass flowrate	kg/h (t/h)*	lb/h
volume	m ³ (l)*	MCF
volume flowrate	m ³ /h (l/h)*	MCF/h
energy	GJ (MJ, MWh, kWh)*	MMBTU
energy flowrate	GJ/h (MJ/h, MW, kW)*	MMBTU/h
pressure	bar (absolute)	PSIA
temperature	°C	°F
density	kg/m ³	lb/CF
gas components	mole %	mole%
time	seconds	seconds

* depending on the settings in the flow computer

10.5.2 Accessing batch data

10.5.2.1 Accessing batch data in case of “Tank loading/unloading” batch

Addresses of Modbus registers related to batch measurement are listed in the table below.

See also 9.1.7.

Modbus register	Reg. type	Description	Note
9000	Read/Write	Register block for batch start/stop on stream 1.	40 registers/stream
...	Read/Write	...	
9280	Read/Write	Register block for batch start/stop on stream 8.	

Offset	Batch parameters	Description
0	Batch start/stop	Integer, 1 – start batch, 0 – stop batch (1 reg.)
1	Copy of printed reports	Integer, (0,1,2,3 copy) (1 reg.)
2-21	Tank car route (from/to)	40 x ASCII character (20 reg.)
22-26	Number plate of the car	10 x ASCII character (5 reg.)
27	Reserved	(1 reg.)
28-29	Batch required quantity	floating point number (2 reg.)
30-39	Reserved	(10 reg.)

9320	ReadOnly	Register block for measured batch quantities on stream 1 (ongoing batch data if batch is in progress, last batch data if batch is not in progress)	60 registers/stream
...	ReadOnly	...	
9740	ReadOnly	Register block for measured batch quantities on stream 8 (ongoing batch data if batch is in progress, last batch data if batch is not in progress)	

Offset	Batch quantities	Description		
0	Batch status	Integer, 1 – in progress, 0 – finished (1 reg.)		
1-5	Loading station (stream name)	10 x ASCII character (5 reg.)		
6-25	Tank car route (from/to)	40 x ASCII character (20 reg.)		
26-30	Number plate of the car	10 x ASCII character (5 reg.)		
31	Batch start time	Year (H)	Month (L)	Integer (3 reg.)
32		Day (H)	Hour (L)	
33		Minute (H)	Second (L)	
34	Batch stop time	Year (H)	Month (L)	Integer (3 reg.)
35		Day (H)	Hour (L)	
36		Minute(H)	Second (L)	
37	Reserved	(1 reg.)		
38-39	Batch mass	(see Note 1) (2 reg.)		
40-41	Batch volume at base condition	(see Note 1) (2 reg.)		
42-43	Batch average base density [kg/m ³]	floating point number (2 reg.)		
44-45	Batch average temperature [°C]	floating point number (2 reg.)		
46-47	Batch average line density [kg/m ³]	floating point number (2 reg.)		
48-49	Batch average concentration %(m/m)	floating point number (2 reg.)		
50-51	Batch average measured density [kg/m ³]	floating point number (2 reg.)		
52-53	Batch average absolute pressure [bar]	floating point number (2 reg.)		
54-55	Batch average gauge pressure [bar]	floating point number (2 reg.)		
56-57	Batch volume at line conditions	(see Note 1) (2 reg.)		
58-59	Batch average concentration %(v/v)	floating point number (2 reg.)		
Note 1				
The number format is determined by the settings of the Totals format parameter (see 9.2.2.7)				

10.5.2.2 Accessing batch data in case of “Pipeline product interface” batch

Addresses of Modbus registers related to batch measurement are listed in the table below.

See also 9.1.7.

Modbus register	Reg. type	Description	Note
9000	Read/Write	Register block for batch start/stop on stream 1.	40 registers/stream
...	Read/Write	...	
9280	Read/Write	Register block for batch start/stop on stream 8.	

Offset	Batch parameters	Description
0	Batch start/stop	Integer, 1 – start batch, 0 – stop batch (1 reg.)
1	Batch identifier	Integer (1 reg.)
2	Batch product code	integer (1 reg.)
3	Batch product name	10 x ASCII character (5 reg.)
8-38	Reserved	(31 reg.)
39	Reserved	(0 reg.)

9320	ReadOnly	Register block for measured batch quantities on stream 1 (ongoing batch data if batch is in progress, last batch data if batch is not in progress).	60 registers/stream
...	ReadOnly	...	
9740	ReadOnly	Register block for measured batch quantities on stream 8 (ongoing batch data if batch is in progress, last batch data if batch is not in progress)	

Offset	Batch quantities	Description
0	Batch status	Integer, 1 – in progress, 0 – finished (1 reg.)
1	Batch identifier	Integer (1 reg.)
2	Batch product code	Integer (1 reg.)
3-7	Batch product name	10 x ASCII character (5 reg.)
8-12	Loading station (stream name)	10 x ASCII character (5 reg.)
13-22	Batch start time (yyyy-mm-dd hh:mm:ss)	20 x ASCII character (10 reg.)
23-32	Batch stop time (yyyy-mm-dd hh:mm:ss)	20 x ASCII character (10 reg.)
33	Reserved	(0 reg.)
34-35	Batch average absolute pressure [bar]	floating point number (2 reg.)
36-37	Batch average temperature [°C]	floating point number (2 reg.)
38-39	Batch average base density [kg/m ³]	floating point number (2 reg.)
40-41	Batch volume at base condition	floating point number (2 reg.)
42-43	Batch volume at line conditions	floating point number (2 reg.)
44-45	Batch mass	floating point number (2 reg.)
46-47	Batch average gauge pressure [bar]	floating point number (2 reg.)
48-49	Batch average line density [kg/m ³]	floating point number (2 reg.)
50-59	Reserved	(5 reg.)

10000	ReadOnly	Register block for the last finished batch quantities on stream 1.	180 registers/stream
10060	ReadOnly	Register block for the second last finished batch quantities on stream 1.	
10120	ReadOnly	Register block for the third last finished batch quantities on stream 1.	
...	
11260	ReadOnly	Register block for the last finished batch quantities on stream 8.	
11320	ReadOnly	Register block for the second last finished batch quantities on stream 8.	

11380	ReadOnly	Register block for the third last finished batch quantities on stream 8.	
-------	----------	--	--

Offset	Batch quantities	Description
0	Batch status	Integer, 1 – in progress, 0 – finished (1 reg.)
1	Batch identifier	Integer (1 reg.)
2	Batch product code	Integer (1 reg.)
3-7	Batch product name	10 x ASCII character (5 reg.)
8-12	Loading station (stream name)	10 x ASCII character (5 reg.)
13-22	Batch start time (yyyy-mm-dd hh:mm:ss)	20 x ASCII character (10 reg.)
23-32	Batch stop time (yyyy-mm-dd hh:mm:ss)	20 x ASCII character (10 reg.)
33	Reserved	(0 reg.)
34-35	Batch average absolute pressure [bar]	floating point number (2 reg.)
36-37	Batch average temperature [°C]	floating point number (2 reg.)
38-39	Batch average base density [kg/m ³]	floating point number (2 reg.)
40-41	Batch volume at base condition	floating point number (2 reg.)
42-43	Batch volume at line conditions	floating point number (2 reg.)
44-45	Batch mass	floating point number (2 reg.)
46-47	Batch average gauge pressure [bar]	floating point number (2 reg.)
48-49	Batch average line density [kg/m ³]	floating point number (2 reg.)
50-59	Reserved	(5 reg.)

10.5.3 Accessing flow meter serial test data

Addresses of Modbus registers related to meter serial test measurement are listed in the table below. See also 9.1.8. Flow meter serial test data are available via link (Ethernet or serial) set to Daniel Modbus register assignment.

MASTER/ SLAVE registers (2 byte) read only	SLAVE registers (2 byte) read/write to control serial test	MASTER registers (2 byte) read/write to control serial test from upper level (DCS)	Description	Unit of measurement	Data format / Note
20		2600	Function 1 – custody transfer measurement 2 – non custody transfer measurement		
21		2601	not used		
22		2602	not used		
23	2051	2603	Duration of the test	minute	16 bit unsigned integer
24	2052	2604	Start command = 0, idle = 1, start	-	16 bit unsigned integer
25	2053	2605	Stop command = 0, idle = 1, stop (finish test) = 2, abort (abort test)	-	16 bit unsigned integer
26		2606	Serial test status = 0, idle = 1, starting = 2, running = 3, data processing = 4, ready	-	16 bit unsigned integer
27		2607	Elapsed time	minute	16 bit unsigned integer

28		2608	Cycle counter	-	16 bit unsigned integer
29		2609	not used		
30			not used		
31-48			Stream name	-	ASCII string – read only
49			Stream serial number (1 to 8)	-	16 bit unsigned integer
50			serial test start Month Year	-	16 bit unsigned integer
51			serial test start Hour Day	-	16 bit unsigned integer
52			serial test start Second Minute	-	16 bit unsigned integer
53			not used		
54			serial test stop Month Year	-	16 bit unsigned integer
55			serial test stop Hour Day	-	16 bit unsigned integer
56			serial test stop Second Minute	-	16 bit unsigned integer
57			not used		
58			serial test volume at line conditions	m3	32 bit float
60			serial test volume at line conditions converted to the pressure and temperature in the master line	m3	32 bit float
62			serial test volume at base conditions	m3	32 bit float
64			serial test mass	kg	32 bit float
66			serial test energy	GJ	32 bit float
68			serial test average pressure	barA	32 bit float
70			serial test average temperature	°C	32 bit float
72			serial test average compression factor at line conditions	-	32 bit float
74			serial test average compression factor at base conditions	-	32 bit float
76			serial test average volume flow rate at line conditions	m3/h	32 bit float
78			serial test average volume flow rate at line conditions converted to the pressure and temperature in the master line	m3/h	32 bit float
80			serial test average volume flow rate at base conditions	m3/h	32 bit float
82			serial test average mass flow rate	kg/h	32 bit float
84			serial test average energy flow rate	GJ/h	32 bit float
86			serial test average relative density	-	32 bit float
88			serial test average base density	kg/m3	32 bit float
90			serial test average line density	kg/m3	32 bit float
92			serial test average relative density converted to the pressure and temperature in the master line	kg/m3	32 bit float
94			serial test average inferior heating value	MJ/m3	32 bit float
96			serial test average superior heating value	MJ/m3	32 bit float

98			serial test average differential pressure	mbar	32 bit float
100			serial test average nitrogen	mole%	32 bit float
102			serial test average carbon-dioxide	mole%	32 bit float
104			serial test average H2S	mole%	32 bit float
106			serial test average H2O	mole%	32 bit float
108			serial test average helium	mole%	32 bit float
110			serial test average methane	mole%	32 bit float
112			serial test average ethane	mole%	32 bit float
114			serial test average propane	mole%	32 bit float
116			serial test average n-butane	mole%	32 bit float
118			serial test average i-butane	mole%	32 bit float
120			serial test average n-pentane	mole%	32 bit float
122			serial test average i-pentane	mole%	32 bit float
124			serial test average hexane	mole%	32 bit float
126			serial test average heptane	mole%	32 bit float
128			serial test average octane	mole%	32 bit float
130			serial test average nonane	mole%	32 bit float
132			serial test average decane	mole%	32 bit float
134			serial test average oxygen	mole%	32 bit float
136			serial test average carbon-monoxide	mole%	32 bit float
138			serial test average hydrogen	mole%	32 bit float
140			serial test average argon	mole%	32 bit float
142			serial test average total moles	mole%	32 bit float

Note: batch data and serial test data are available in metric units only.

10.6 Daniel Modbus register map (4 byte/register)

10.6.1 Registers for system date and time modification via Modbus link

Register address	Data type	Description
1	16 bit integer	Downloaded Year (4 digits) (1900...2999)
2	16 bit integer	Downloaded Month (1...12)
3	16 bit integer	Downloaded Day (1...31)
4	16 bit integer	Downloaded Hour (0...23)
5	16 bit integer	Downloaded Minute (0...59)
6	16 bit integer	Downloaded Second (0...59)
7	16 bit integer	Accept time Write 1 to this register to accept the downloaded date and time and set it as current date and time. After accepting the time flow computer writes it to 0.
8 ... 10	16 bit integer	n/a
11	16 bit integer	System clock Year (4 digits)
12	16 bit integer	System clock Month
13	16 bit integer	System clock Day
14	16 bit integer	System clock Hour
15	16 bit integer	System clock Minute
16	16 bit integer	System clock Second
17 ... 20	16 bit integer	n/a

Modify the time in steps:

1. Write the desired new date and time into registers 1 to 6.
2. Write 1 to register 7. Writing register 7 to 1 can be done in one message together with the date and time writing.
3. UNIFLOW-200 accepts the new date and time and writes register 7 back to 0.

10.6.2 Registers for totals

Register address	Data type	Description
5001	32 bit integer	Current hour volume at base conditions (CVOL)
5002	32 bit integer	Current day volume at base conditions (CVOL)
5003	32 bit integer	Current multiday volume at base conditions (CVOL)
5004	32 bit integer	Current month volume at base conditions (CVOL)
5005	32 bit integer	Previous hour volume at base conditions (CVOL)
5006	32 bit integer	Previous day volume at base conditions (CVOL)
5007	32 bit integer	Previous multiday volume at base conditions (CVOL)
5008	32 bit integer	Previous month volume at base conditions (CVOL)
5009	32 bit integer	Volume at base conditions (CVOL) cumulative total
5010	32 bit integer	n/a
5011	32 bit integer	Current hour carbon mass
5012	32 bit integer	Current day carbon mass
5013	32 bit integer	Current multiday carbon mass
5014	32 bit integer	Current month carbon mass
5015	32 bit integer	Previous hour carbon mass
5016	32 bit integer	Previous day carbon mass
5017	32 bit integer	Previous multiday carbon mass
5018	32 bit integer	Previous month carbon mass
5019	32 bit integer	Carbon mass cumulative total
5020	32 bit integer	n/a
5021	32 bit integer	Current hour energy
5022	32 bit integer	Current day energy
5023	32 bit integer	Current multiday energy

5024	32 bit integer	Current month energy
5025	32 bit integer	Previous hour energy
5026	32 bit integer	Previous day energy
5027	32 bit integer	Previous multiday energy
5028	32 bit integer	Previous month energy
5029	32 bit integer	Energy cumulative total
5030	32 bit integer	n/a
5031	32 bit integer	n/a
5032	32 bit integer	n/a
5033	32 bit integer	n/a
5034	32 bit integer	n/a
5035	32 bit integer	n/a
5036	32 bit integer	n/a
5037	32 bit integer	n/a
5038	32 bit integer	n/a
5039	32 bit integer	n/a
5040	32 bit integer	n/a
5041	32 bit integer	Current day premium volume at base conditions (CVOL)
5042	32 bit integer	Current multiday premium volume at base conditions (CVOL)
5043	32 bit integer	Current month premium volume at base conditions (CVOL)
5044	32 bit integer	Previous hour premium volume at base conditions (CVOL)
5045	32 bit integer	Previous day premium volume at base conditions (CVOL)
5046	32 bit integer	Previous multiday premium volume at base conditions (CVOL)
5047	32 bit integer	Previous month premium volume at base conditions (CVOL)
5048	32 bit integer	Premium volume at base conditions (CVOL) cumulative total
5049	32 bit integer	n/a
5050	32 bit integer	n/a
5051	32 bit integer	Current hour raw volume at line conditions
5052	32 bit integer	Current day raw volume at line conditions
5053	32 bit integer	Current multiday raw volume at line conditions
5054	32 bit integer	Current month raw volume at line conditions
5055	32 bit integer	Previous hour raw volume at line conditions
5056	32 bit integer	Previous day raw volume at line conditions
5057	32 bit integer	Previous multiday raw volume at line conditions
5058	32 bit integer	Previous month raw volume at line conditions
5059	32 bit integer	Raw volume at line conditions, cumulative total
5060	32 bit integer	n/a
5061	32 bit integer	Current hour volume at line conditions (UVOL)
5062	32 bit integer	Current day volume at line conditions (UVOL)
5063	32 bit integer	Current multiday volume at line conditions (UVOL)
5064	32 bit integer	Current month volume at line conditions (UVOL)
5065	32 bit integer	Previous hour volume at line conditions (UVOL)
5066	32 bit integer	Previous day volume at line conditions (UVOL)
5067	32 bit integer	Previous multiday volume at line conditions (UVOL)
5068	32 bit integer	Previous month volume at line conditions (UVOL)
5069	32 bit integer	Volume at line conditions (UVOL) cumulative total
5070	32 bit integer	n/a
5071	32 bit integer	Current hour fault volume at base conditions (CVOL)
5072	32 bit integer	Current day fault volume at base conditions (CVOL)
5073	32 bit integer	Current multiday fault volume at base conditions (CVOL)
5074	32 bit integer	Current month fault volume at base conditions (CVOL)
5075	32 bit integer	Previous hour fault volume at base conditions (CVOL)
5076	32 bit integer	Previous day fault volume at base conditions (CVOL)
5077	32 bit integer	Previous multiday fault volume at base conditions (CVOL)
5078	32 bit integer	Previous month fault volume at base conditions (CVOL)

5079	32 bit integer	Fault volume at base conditions (CVOL) cumulative total
5080	32 bit integer	n/a
5081	32 bit integer	n/a
5082	32 bit integer	n/a
5083	32 bit integer	n/a
5084	32 bit integer	n/a
5085	32 bit integer	UVOL FWD total (read from ultrasonic meter)
5086	32 bit integer	Fault UVOL FWD total (read from ultrasonic meter)
5087	32 bit integer	UVOL REV total (read from ultrasonic meter)
5088	32 bit integer	Fault UVOL REV total (read from ultrasonic meter)
5089	32 bit integer	LF pulse counter cumulative total
5090	32 bit integer	n/a
5091	32 bit integer	Current month maximum hourly volume at base conditions (CVOL)
5092	32 bit integer	Current month maximum hourly volume at base conditions (CVOL), month
5093	32 bit integer	Current month maximum hourly volume at base conditions (CVOL), day
5094	32 bit integer	Current month maximum hourly volume at base conditions (CVOL), hour
5095	32 bit integer	Previous month maximum hourly volume at base conditions (CVOL)
5096	32 bit integer	Previous month maximum hourly volume at base conditions (CVOL), month
5097	32 bit integer	Previous month maximum hourly volume at base conditions (CVOL), day
5098	32 bit integer	Previous month maximum hourly volume at base conditions (CVOL), hour
5099	32 bit integer	n/a
5100	32 bit integer	n/a
5101	32 bit integer	Current day hourly volume at base conditions (CVOL) at end-of-day hour+1 hour
5102	32 bit integer	Same for +2 hours
5103	32 bit integer	Same for +3 hours
5104	32 bit integer	Same for +4 hours
5105	32 bit integer	Same for +5 hours
5106	32 bit integer	Same for +6 hours
5107	32 bit integer	Same for +7 hours
5108	32 bit integer	Same for +8 hours
5109	32 bit integer	Same for +9 hours
5110	32 bit integer	Same for +10 hours
5111	32 bit integer	Same for +11 hours
5112	32 bit integer	Same for +12 hours
5113	32 bit integer	Same for +13 hours
5114	32 bit integer	Same for +14 hours
5115	32 bit integer	Same for +15 hours
5116	32 bit integer	Same for +16 hours
5117	32 bit integer	Same for +17 hours
5118	32 bit integer	Same for +18 hours
5119	32 bit integer	Same for +19 hours
5120	32 bit integer	Same for +20 hours
5121	32 bit integer	Same for +21 hours
5122	32 bit integer	Same for +22 hours
5123	32 bit integer	Same for +23 hours
5124	32 bit integer	Same for +24 hours
5125	32 bit integer	Current day hourly energy at end-of-day hour+1 hour
5126	32 bit integer	Same for +2 hours
5127	32 bit integer	Same for +3 hours
5128	32 bit integer	Same for +4 hours
5129	32 bit integer	Same for +5 hours
5130	32 bit integer	Same for +6 hours
5131	32 bit integer	Same for +7 hours
5132	32 bit integer	Same for +8 hours

5133	32 bit integer	Same for +9 hours
5134	32 bit integer	Same for +10 hours
5135	32 bit integer	Same for +11 hours
5136	32 bit integer	Same for +12 hours
5137	32 bit integer	Same for +13 hours
5138	32 bit integer	Same for +14 hours
5139	32 bit integer	Same for +15 hours
5140	32 bit integer	Same for +16 hours
5141	32 bit integer	Same for +17 hours
5142	32 bit integer	Same for +18 hours
5143	32 bit integer	Same for +19 hours
5144	32 bit integer	Same for +20 hours
5145	32 bit integer	Same for +21 hours
5146	32 bit integer	Same for +22 hours
5147	32 bit integer	Same for +23 hours
5148	32 bit integer	Same for +24 hours

10.6.3 Registers for other measured data

Register address	Data type	Description
7001	32 bit floating	Downloaded Nitrogen
7002	32 bit floating	Downloaded Carbon-dioxide
7003	32 bit floating	Downloaded Hydrogen-sulfide
7004	32 bit floating	Downloaded Water
7005	32 bit floating	Downloaded Helium
7006	32 bit floating	Downloaded Methane
7007	32 bit floating	Downloaded Ethane
7008	32 bit floating	Downloaded Propane
7009	32 bit floating	Downloaded n-Butane
7010	32 bit floating	Downloaded i-Butane
7011	32 bit floating	Downloaded n-Pentane
7012	32 bit floating	Downloaded i-Pentane
7013	32 bit floating	Downloaded n-Hexane
7014	32 bit floating	Downloaded n-Heptane
7015	32 bit floating	Downloaded n-Octane
7016	32 bit floating	Downloaded n-Nonane
7017	32 bit floating	Downloaded n-Decane
7018	32 bit floating	Downloaded Oxygen
7019	32 bit floating	Downloaded Carbon-monoxide
7020	32 bit floating	Downloaded Hydrogen
7021	32 bit floating	Downloaded Relative density
7022	32 bit floating	Downloaded Inferior calorific value
7023	32 bit floating	Downloaded Superior calorific value
7024	32 bit floating	Downloaded argon
7025	32 bit floating	Line density
7026	32 bit floating	Base density
7027	32 bit floating	Specific carbon content
7028	32 bit floating	n/a
7029	32 bit floating	n/a
7030	32 bit floating	Downloaded Ethylene
7031	32 bit floating	Fluid pressure, absolute
7032	32 bit floating	Fluid temperature
7033	32 bit floating	Differential pressure

7034	32 bit floating	Volume at base conditions (CVOL) flowrate
7035	32 bit floating	Energy flowrate
7036	32 bit floating	Volume at line conditions (UVOL) flowrate
7037	32 bit floating	n/a
7038	32 bit floating	n/a
7039	32 bit floating	Carbon mass flowrate
7040	32 bit floating	n/a
7041	32 bit floating	Current day average pressure, absolute
7042	32 bit floating	Current day average temperature
7043	32 bit floating	Current day average compression factor ($K=Z_{line}/Z_{base}$), -
7044	32 bit floating	Previous day average pressure, absolute
7045	32 bit floating	Previous day average temperature
7046	32 bit floating	Previous day average compression factor ($K=Z_{line}/Z_{base}$), -
7047	32 bit floating	Current month average pressure, absolute
7048	32 bit floating	Current month average temperature
7049	32 bit floating	Current month average compression factor ($K=Z_{line}/Z_{base}$), -
7050	32 bit floating	Previous month average pressure, absolute
7051	32 bit floating	Previous month average temperature
7052	32 bit floating	Previous month average compression factor ($K=Z_{line}/Z_{base}$), -
7053	32 bit floating	n/a
7054	32 bit floating	n/a
7055	32 bit floating	Pressure measured at IO channel
7056	32 bit floating	Differential pressure (dP low) measured at IO channel
7057	32 bit floating	Differential pressure (dP medium) measured at IO channel
7058	32 bit floating	Differential pressure (dP high) measured at IO channel
7059	32 bit floating	Temperature measured at 4-20 mA IO channel
7060	32 bit floating	n/a
7061	32 bit floating	Relative density measured at IO channel
7062	32 bit floating	CO2 content measured at IO channel, mole%
7063	32 bit floating	N2 content measured at IO channel, mole%
7064	32 bit floating	Inferior calorific value measured at IO channel
7065	32 bit floating	Temperature measured at Pt100 IO channel
7066	32 bit floating	n/a
7067	32 bit floating	Linear gas velocity
7068	32 bit floating	n/a
7069	32 bit floating	n/a
7070	32 bit floating	n/a
7071	32 bit floating	Current hour fault time, hour
7072	32 bit floating	Current day fault time, hour
7073	32 bit floating	Current multiday fault time, hour
7074	32 bit floating	Current month fault time, hour
7075	32 bit floating	Previous hour fault time, hour
7076	32 bit floating	Previous day fault time, hour
7077	32 bit floating	Previous multiday fault time, hour
7078	32 bit floating	Previous month fault time, hour
7079	32 bit floating	Fault time cumulative total, hour
7080	32 bit floating	n/a
7081	32 bit floating	n/a
7082	32 bit floating	n/a
7083	32 bit floating	n/a
7084	32 bit floating	n/a
7085	32 bit floating	n/a
7086	32 bit floating	n/a
7087	32 bit floating	n/a
7088	32 bit floating	n/a

7089	32 bit floating	n/a
7090	32 bit floating	n/a
7091	32 bit floating	Current hour flow time, hour
7092	32 bit floating	Current day flow time, hour
7093	32 bit floating	Current multiday flow time, hour
7094	32 bit floating	Current month flow time, hour
7095	32 bit floating	Previous hour flow time, hour
7096	32 bit floating	Previous day flow time, hour
7097	32 bit floating	Previous multiday flow time, hour
7098	32 bit floating	Previous month flow time, hour
7099	32 bit floating	Flow time cumulative total, hour

Unit of measurement for the quantities listed in tables above are as follows:

	METRIC UNIT		IMPERIAL UNIT
mass	kg (t)*		lb
mass flowrate	kg/h (t/h)*		lb/h
volume	m ³ (or l)*	MCF	
volume flowrate	m ³ /h (or l/h)*		MCF/h
energy	GJ (MJ, MWh, kWh)*		MMBTU
energy flowrate	GJ/h (MJ/h, MW, kW)*		MMBTU/h
pressure	bar		PSIA or PSIG
temperature	°C		°F
density line, base	kg/m ³		lb/CF
relative density	-		-
calorific value	MJ/m ³		BTU/SCF
gas component content	mole %		mole%
differential pressure	mbar		inchH ₂ O
linear gas velocity	m/s		ft/s
compression factor	-		-
specific carbon content	kg/m ³		lb/CF
time	seconds	seconds	

* depending on the settings in the flow computer

10.7 Register maps of the Modbus Slave devices

Uniflow-200 is capable to communicate with different Modbus Slave devices (gas chromatographs, ultrasonic meters, mass flow meters). The Modbus registers read from these Modbus Slave devices are described below. In case of difficulties in establishing communication with Modbus Slave devices it is recommended to check if the registers in the Modbus Slave device are mapped as listed in the Tables below.

10.7.1 Register map of Caldon LEFM 380Ci ultrasonic meter

Register address	Data type	Description	Unit	Remark
5000	float32	Volume flow rate at line conditions	m ³ /h	
5002	float32	Fluid Temperature Input	deg C	
5004	float32	Average Cf (VOS)	m/s	
5006	float32	Meter Body Temp	deg C	
5008	float32	Pressure	bar	
5010	float32	Average fluid velocity	m/s	
5012	float32	Profile Factor Meter has Calculated	-	
5014	float32	Flatness Ratio	-	
5016	float32	Swirl Ratio	-	
5018	float32	Asymmetry Ratio	-	
5020	float32	Plane Ratio	-	
5022	float32	A/I 1	V	
5024	float32	A/I 2	V	
5052	float32	Velocity of Sound Path 1	m/s	
5054	float32	Velocity of Sound Path 2	m/s	
5056	float32	Velocity of Sound Path 3	m/s	
5058	float32	Velocity of Sound Path 4	m/s	
5060	float32	Velocity of Sound Path 5	m/s	
5062	float32	Velocity of Sound Path 6	m/s	
5064	float32	Velocity of Sound Path 7	m/s	
5066	float32	Velocity of Sound Path 8	m/s	
5068	float32	Measured Fluid Velocity Path 1	m/s	
5070	float32	Measured Fluid Velocity Path 2	m/s	
5072	float32	Measured Fluid Velocity Path 3	m/s	
5074	float32	Measured Fluid Velocity Path 4	m/s	
5076	float32	Measured Fluid Velocity Path 5	m/s	
5078	float32	Measured Fluid Velocity Path 6	m/s	
5080	float32	Measured Fluid Velocity Path 7	m/s	
5082	float32	Measured Fluid Velocity Path 8	m/s	
5084	float32	Normalized Velocity Path 1	-	
5086	float32	Normalized Velocity Path 2	-	
5088	float32	Normalized Velocity Path 3	-	
5090	float32	Normalized Velocity Path 4	-	

5092	float32	Normalized Velocity Path 5	-	
5094	float32	Normalized Velocity Path 6	-	
5096	float32	Normalized Velocity Path 7	-	
5098	float32	Normalized Velocity Path 8	-	
5100	float32	Average Gain Path 1	dB	
5102	float32	Average Gain Path 2	dB	
5104	float32	Average Gain Path 3	dB	
5106	float32	Average Gain Path 4	dB	
5108	float32	Average Gain Path 5	dB	
5110	float32	Average Gain Path 6	dB	
5112	float32	Average Gain Path 7	dB	
5114	float32	Average Gain Path 8	dB	
5116	float32	Gain Path1 UP	dB	
5118	float32	Gain Path2 UP	dB	
5120	float32	Gain Path3 UP	dB	
5122	float32	Gain Path4 UP	dB	
5124	float32	Gain Path5 UP	dB	
5126	float32	Gain Path6 UP	dB	
5128	float32	Gain Path7 UP	dB	
5130	float32	Gain Path8 UP	dB	
5132	float32	Gain Path1 Down	dB	
5134	float32	Gain Path2 Down	dB	
5136	float32	Gain Path3 Down	dB	
5138	float32	Gain Path4 Down	dB	
5140	float32	Gain Path5 Down	dB	
5142	float32	Gain Path6 Down	dB	
5144	float32	Gain Path7 Down	dB	
5146	float32	Gain Path8 Down	dB	
5148	float32	Transit time down Path 1	ns	
5150	float32	Transit time down Path 2	ns	
5152	float32	Transit time down Path 3	ns	
5154	float32	Transit time down Path 4	ns	
5156	float32	Transit time down Path 5	ns	
5158	float32	Transit time down Path 6	ns	
5160	float32	Transit time down Path 7	ns	
5162	float32	Transit time down Path 8	ns	
5164	float32	Transit time up Path 1	ns	
5166	float32	Transit time up Path 2	ns	
5168	float32	Transit time up Path 3	ns	
5170	float32	Transit time up Path 4	ns	
5172	float32	Transit time up Path 5	ns	
5174	float32	Transit time up Path 6	ns	

5176	float32	Transit time up Path 7	ns	
5178	float32	Transit time up Path 8	ns	
5180	float32	Delta Time Path 1	ns	
5182	float32	Delta Time Path 2	ns	
5184	float32	Delta Time Path 3	ns	
5186	float32	Delta Time Path 4	ns	
5188	float32	Delta Time Path 5	ns	
5190	float32	Delta Time Path 6	ns	
5192	float32	Delta Time Path 7	ns	
5194	float32	Delta Time Path 8	ns	
5196	float32	Turbulent Intensity Path 1	%	
5198	float32	Turbulent Intensity Path 2	%	
5200	float32	Turbulent Intensity Path 3	%	
5202	float32	Turbulent Intensity Path 4	%	
5204	float32	Turbulent Intensity Path 5	%	
5206	float32	Turbulent Intensity Path 6	%	
5208	float32	Turbulent Intensity Path 7	%	
5210	float32	Turbulent Intensity Path 8	%	

10000	int16	Positive Totalizer MSB	m3	
10001	int16	Positive Totalizer LSB	m3	
10002	int16	Negative Totalizer MSB	m3	
10003	int16	Negative Totalizer LSB	m3	
10004	int16	Years	year	
10005	int16	Month	month	
10006	int16	Hours Day	day	
10007	int16	Hours	hours	
10008	int16	Minutes	minutes	
10009	int16	Seconds	seconds	
10010	int16	Board Status	-	
10011	int16	MeterStateVector	-	
10012	int16	Firmware Version	-	
10013	int16	Firmware Revision 1	-	
10014	int16	Firmware Revision 2	-	
10015	int16	Firmware Revision 3	-	
10016	int16	Checksum of Executable Code	-	
10017	int16	Checksum of Parameter Set	-	
10018	int16	Number of Times Parameter Set has sent	-	
10019	int16	Switch Settings	-	
10020	int16	Analog Input Status	-	
10051	int16	Performance 1	%	
10052	int16	Performance 2	%	

10053	int16	Performance 3	%	
10054	int16	Performance 4	%	
10055	int16	Performance 5	%	
10056	int16	Performance 6	%	
10057	int16	Performance 7	%	
10058	int16	Performance 8	%	
10059	int16	Average Up/Dn SNR Path 1	-	
10060	int16	Average Up/Dn SNR Path 2	-	
10061	int16	Average Up/Dn SNR Path 3	-	
10062	int16	Average Up/Dn SNR Path 4	-	
10063	int16	Average Up/Dn SNR Path 5	-	
10064	int16	Average Up/Dn SNR Path 6	-	
10065	int16	Average Up/Dn SNR Path 7	-	
10066	int16	Average Up/Dn SNR Path 8	-	
10067	int16	SNR Up 1	-	
10068	int16	SNR Up 2	-	
10069	int16	SNR Up 3	-	
10070	int16	SNR Up 4	-	
10071	int16	SNR Up 5	-	
10072	int16	SNR Up 6	-	
10073	int16	SNR Up 7	-	
10074	int16	SNR Up 8	-	
10075	int16	SNR Dn 1	-	
10076	int16	SNR Dn 2	-	
10077	int16	SNR Dn 3	-	
10078	int16	SNR Dn 4	-	
10079	int16	SNR Dn 5	-	
10080	int16	SNR Dn 6	-	
10081	int16	SNR Dn 7	-	
10082	int16	SNR Dn 8	-	
10083	int16	Path Status 1	-	
10084	int16	Path Status 2	-	
10085	int16	Path Status 3	-	
10086	int16	Path Status 4	-	
10087	int16	Path Status 5	-	
10088	int16	Path Status 6	-	
10089	int16	Path Status 7	-	
10090	int16	Path Status 8	-	

10.7.2 Register map of Daniel ultrasonic meter (Mark III electronics)

Register address	Data type	Description	Unit	Remark
------------------	-----------	-------------	------	--------

62	int16	Chord A status		
63	int16	Chord B status		
64	int16	Chord C status		
65	int16	Chord D status		
66	int16	System status		
67	int16	Percentage of good batch firings (path A1).	%	
68	int16	Percentage of good batch firings (path B1).	%	
69	int16	Percentage of good batch firings (path C1).	%	
70	int16	Percentage of good batch firings (path D1).	%	
71	int16	Percentage of good batch firings (path A2).	%	
72	int16	Percentage of good batch firings (path B2).	%	
73	int16	Percentage of good batch firings (path C2).	%	
74	int16	Percentage of good batch firings (path D2).	%	
77	int16	Gain (path A1)		
78	int16	Gain (path A2)		
79	int16	Gain (path B1)		
80	int16	Gain (path B2)		
81	int16	Gain (path C1)		
82	int16	Gain (path C2)		
83	int16	Gain (path D1)		
84	int16	Gain (path D2)		
352	float32	Chord A flow velocity	m/s	
354	float32	Chord B flow velocity	m/s	
356	float32	Chord C flow velocity	m/s	
358	float32	Chord D flow velocity	m/s	
360	float32	Average flow velocity	m/s	
362	float32	Chord A sound velocity.	m/s	
364	float32	Chord B sound velocity.	m/s	
366	float32	Chord C sound velocity.	m/s	
368	float32	Chord D sound velocity.	m/s	
370	float32	Average sound velocity.	m/s	
394	float32	Low flow cut-off	m ³ /h	
1500	int32	Forward volume at line conditions (integer portion).	m ³	
1502	int32	Reverse volume at line conditions (integer portion).	m ³	
10600	float32	Flow-condition temperature.	°C	
10602	float32	Flow-condition pressure	MPa	

10624	float32	Flow-condition volumetric flow rate (includes expansion and profile-effect correction).	m ³ /h	
10626	float32	Base-condition volumetric flow rate.	m ³ /h	

10.7.3 Register map of Flexim Fluxus ultrasonic meter

Register address	Data type	Description	Unit	Remark
1000	int16	Gas temperature status		
1001	float32	Gas temperature	°C	
1032	int16	Gas pressure status		
1033	float32	Gas pressure	bar	
1064	int16	Signal amplitude status		
1065	float32	Signal amplitude		
1080	int16	Velocity of sound status		
1081	float32	Velocity of sound	m/s	
1096	int16	Velocity of gas status		
1097	float32	Velocity of gas	m/s	
1112	int16	Volume flow rate at line conditions status		
1113	float32	Volume flow rate at line conditions	m ³ /h	
1128	int16	Volume flow totalizer at line conditions (positive) status		
1129	float32	Volume flow totalizer at line conditions (positive)	m ³	
1144	int16	Volume flow totalizer at line conditions (negative) status		
1145	float32	Volume flow totalizer at line conditions (negative)	m ³	
1160	int16	Volume flow rate at base conditions status		
1161	float32	Volume flow rate at base conditions	m ³ /h	

10.7.4 Register map of Sick-Maihak Flowsic-600 ultrasonic meter

Register address	Data type	Description	Unit	Remark
3002	int16	System control		
3003	int16	System status		
3004	int16	Path 1 status		
3005	int16	Path 2 status		
3006	int16	Path 3 status		
3007	int16	Path 4 status		
3008	int16	Path 1 valid samples		
3009	int16	Path 2 valid samples		
3010	int16	Path 3 valid samples		
3011	int16	Path 4 valid samples		
3012	int16	AGC level path 1A		

3013	int16	AGC level path 1B		
3014	int16	AGC level path 2A		
3015	int16	AGC level path 2B		
3016	int16	AGC level path 3A		
3017	int16	AGC level path 3B		
3018	int16	AGC level path 4A		
3019	int16	AGC level path 4B		
5010	int32	Forward volume		
5011	int32	Forward volume error		
5012	int32	Reverse volume		
5013	int32	Reverse volume error		
5014	int32	Counter resolution		
7001	float32	Volume flow rate at line conditions	m ³ /h	
7002	float32	Volume flow rate at base conditions	m ³ /h	
7003	float32	Velocity of sound	m/s	
7004	float32	Gas velocity	m/s	
7005	float32	Path 1 VOS	m/s	
7006	float32	Path 2 VOS	m/s	
7007	float32	Path 3 VOS	m/s	
7008	float32	Path 4 VOS	m/s	
7009	float32	Path 1 gas velocity	m/s	
7010	float32	Path 2 gas velocity	m/s	
7011	float32	Path 3 gas velocity	m/s	
7012	float32	Path 4 gas velocity	m/s	
7013	float32	SNR 1A	dB	
7014	float32	SNR 1B	dB	
7015	float32	SNR 1A	dB	
7016	float32	SNR 1B	dB	
7017	float32	SNR 1A	dB	
7018	float32	SNR 1B	dB	
7019	float32	SNR 1A	dB	
7020	float32	SNR 1B	dB	
7021	float32	Gas temperature	K	
7022	float32	Gas pressure	bar (abs)	
7036		Low flow cut-off	m ³ /h	
7037		Adjust factor forward		
7038		Adjust factor reverse		
7039		Zero flow offset	m ³ /h	

10.7.5 Register map of Krohne Altosonic V12 ultrasonic meter

NOTE: All the registers read by Uniflow-200 shall be configured in the Altosonic V12 as holding registers. Uniflow-200 read registers with Modbus command code 3.

Register address	Data type	Description	Unit	Remark
5000	int32	Test data		
5002	int32	System status		
5004	int32	Path 1 status		
5006	int32	Path 2 status		
5008	int32	Path 3 status		
5010	int32	Path 4 status		
5012	int32	Path 5 status		
5014	int32	Path 6 status		
5016	int32	Temperature status		
5018	int32	Totalizer status		
7000	float32	Test data		
7002	float32	Channel gain AB1	dB	
7004	float32	Channel gain AB2	dB	
7006	float32	Channel gain AB3	dB	
7008	float32	Channel gain AB4	dB	
7010	float32	Channel gain AB5	dB	
7012	float32	Channel gain AB6	dB	
7014	float32	Channel gain BA1	dB	
7016	float32	Channel gain BA2	dB	
7018	float32	Channel gain BA3	dB	
7020	float32	Channel gain BA4	dB	
7022	float32	Channel gain BA5	dB	
7024	float32	Channel gain BA6	dB	
7026	float32	Channel SNR AB1	dB	
7028	float32	Channel SNR AB2	dB	
7030	float32	Channel SNR AB3	dB	
7032	float32	Channel SNR AB4	dB	
7034	float32	Channel SNR AB5	dB	
7036	float32	Channel SNR AB6	dB	
7038	float32	Channel SNR BA1	dB	
7040	float32	Channel SNR BA2	dB	
7042	float32	Channel SNR BA3	dB	
7044	float32	Channel SNR BA4	dB	
7046	float32	Channel SNR BA5	dB	
7048	float32	Channel SNR BA6	dB	
7050	float32	Gas temperature	°C	

7052	float32	Gas dynamic viscosity	cP	
7054	float32	Gas density	kg/m ³	
7056	float32	Volume flow rate at line conditions	m ³ /s	
7058	float32	Gas velocity	m/s	
7060	float32	Velocity of sound	m/s	
7062	float32	Gas velocity path 1	m/s	
7064	float32	Gas velocity path 2	m/s	
7066	float32	Gas velocity path 3	m/s	
7068	float32	Gas velocity path 4	m/s	
7070	float32	Gas velocity path 5	m/s	
7072	float32	Gas velocity path 6	m/s	
7074	float32	Velocity of sound path 1	m/s	
7076	float32	Velocity of sound path 2	m/s	
7078	float32	Velocity of sound path 3	m/s	
7080	float32	Velocity of sound path 4	m/s	
7082	float32	Velocity of sound path 5	m/s	
7084	float32	Velocity of sound path 6	m/s	
7086	float32	Reliability path 1	%	
7088	float32	Reliability path 2	%	
7090	float32	Reliability path 3	%	
7092	float32	Reliability path 4	%	
7094	float32	Reliability path 5	%	
7096	float32	Reliability path 6	%	
7098	float32	Average gas velocity path 1	m/s	
7100	float32	Average gas velocity path 2	m/s	
7102	float32	Average gas velocity path 3	m/s	
7104	float32	Average gas velocity path 4	m/s	
7106	float32	Average gas velocity path 5	m/s	
7108	float32	Average gas velocity path 6	m/s	
7110	float32	Average velocity of sound path 1	m/s	
7112	float32	Average velocity of sound path 2	m/s	
7114	float32	Average velocity of sound path 3	m/s	
7116	float32	Average velocity of sound path 4	m/s	
7118	float32	Average velocity of sound path 5	m/s	
7120	float32	Average velocity of sound path 6	m/s	
7122	float32	Average velocity of sound	m/s	
7124	float32	Average volume flow rate at line conditions	m ³ /h	
7126	float32	Volume flow rate standard deviation	%	
7128	float32	Volume flow rate standard deviation, running	%	
7130	float32	Velocity of sound standard deviation	%	
7132	float32	Gas velocity standard deviation path 1	%	
7134	float32	Gas velocity standard deviation path 2	%	

7136	float32	Gas velocity standard deviation path 3	%	
7138	float32	Gas velocity standard deviation path 4	%	
7140	float32	Gas velocity standard deviation path 5	%	
7142	float32	Gas velocity standard deviation path 6	%	
7144	float32	Velocity of sound standard deviation path 1	%	
7146	float32	Velocity of sound standard deviation path 2	%	
7148	float32	Velocity of sound standard deviation path 3	%	
7150	float32	Velocity of sound standard deviation path 4	%	
7152	float32	Velocity of sound standard deviation path 5	%	
7154	float32	Velocity of sound standard deviation path 6	%	
7504	float32	Meter constant forward		
7506	float32	Meter constant reverse		
7536	float32	Max flow rate forward	m ³ /s	
7538	float32	Max flow rate reverse	m ³ /s	
7540	float32	Low flow cut-off forward	m/s	
7542	float32	Low flow cut-off reverse	m/s	
8000	int64	Test data		
8004	int64	Volume flow totalizer at line conditions (forward)	m ³ *1e-6	
8008	int64	Volume flow totalizer at line conditions (reverse)	m ³ *1e-6	
8012	int64	Fault volume flow totalizer at line conditions (forward)	m ³ *1e-6	
8016	int64	Fault volume flow totalizer at line conditions (reverse)	m ³ *1e-6	

10.7.6 Register map of Panametrics GC868 ultrasonic meter

Register address	Data type	Description	Unit	Remark
3	int32	Velocity of gas	m/s	m/s= int32 / 100
5	float32	Volume flow rate at line conditions	m ³ /h	
7	float32	Volume flow rate at base conditions	m ³ /h	
9	int32	Volume flow totalizer at line conditions (forward)	m ³	
11	int32	Volume flow totalizer at line conditions (reverse)	m ³	
13	int16	Divider for volume totalizers		
14	float32	Mass flow rate	kg/h	
16	int32	Mass flow totalizer (forward)	kg	
18	int32	Mass flow totalizer (reverse)	kg	
20	int16	Divider for mass totalizers		
21	int32	Timer		
23	int16	Error code		
24	int32	Velocity of sound	m/s	m/s= int32 / 1000
26	int32	Density	kg/m ³	

28	int32	Signal strength upstream		'=int32 / 10
30	int32	Signal strength downstream		'=int32 / 10
32	int32	Gas temperature	°C	
34	int32	Gas pressure	bar	
36	float32	Signal quality upstream		
38	float32	Signal quality downstream		
40	float32	Amplitude discrimination upstream		
42	float32	Amplitude discrimination downstream		
44	float32	SNR upstream		
46	float32	SNR downstream		

10.7.7 Register map of Instromet Q Sonic Uniform ultrasonic meter

Uniflow-200 receives U_DATA data package (message code: 37) from Instromet Q Sonic meters set to communicate according to Uniform protocol.

See details in documents: Elster-Instromet Digital Communication: UNIFORM Protocol (Measured Data)

Document Code: 99.01.02C.02/2/G

10.7.8 Register map of Instromet Q SonicPlus ultrasonic meter

Register address	Data type	Description	Unit	Remark
0	int16	InstrType		
1	int16	NumPath		
2	int16	SequenceNum LO		
3	int16	SequenceNum HI		
4	int16	SampleRate		
5	int16	ValidSamples L1		
6	int16	ValidSamples L2		
7	int16	ValidSamples L3		
8	int16	ValidSamples L4		
9	int16	ValidSamples L5		
10	int16	ValidSamples L6		
11	int16	ValidSamples L7		
12	int16	ValidSamples L8		
13	int16	AGC L1A	dB	
14	int16	AGC L1B	dB	
15	int16	AGC L2A	dB	
16	int16	AGC L2B	dB	
17	int16	AGC L3A	dB	
18	int16	AGC L3B	dB	
19	int16	AGC L4A	dB	
20	int16	AGC L4B	dB	
21	int16	AGC L1A	dB	

22	int16	AGC L1B	dB	
23	int16	AGC L2A	dB	
24	int16	AGC L2B	dB	
25	int16	AGC L3A	dB	
26	int16	AGC L3B	dB	
27	int16	AGC L4A	dB	
28	int16	AGC L4B	dB	
29	int16	SNR L1A	dB	
30	int16	SNR L1B	dB	
31	int16	SNR L2A	dB	
32	int16	SNR L2B	dB	
33	int16	SNR L3A	dB	
34	int16	SNR L3B	dB	
35	int16	SNR L4A	dB	
36	int16	SNR L4B	dB	
37	int16	SNR L1A	dB	
38	int16	SNR L1B	dB	
39	int16	SNR L2A	dB	
40	int16	SNR L2B	dB	
41	int16	SNR L3A	dB	
42	int16	SNR L3B	dB	
43	int16	SNR L4A	dB	
44	int16	SNR L4B	dB	
45	int16	OperationalStatus		
46	int16	Status2		
200	int32	Diabits L1		
201	int32	Diabits L2		
202	int32	Diabits L3		
203	int32	Diabits L4		
204	int32	Diabits L5		
205	int32	Diabits L6		
206	int32	Diabits L7		
207	int32	Diabits L8		
208	int32	FwdVolume		
209	int32	RevVolume		
210	int32	FwdErrVolume		
211	int32	RevErrVolume		
212	int32	Checksum1		
213	int32	Checksum2		
400	float32	Speed of Sound	m/s	

401	float32	Velocity of gas	m/s	
402	float32	Pressure	kPa	
403	float32	Temperature	K	
404	float32	QLine	m3/h	
405	float32	QBase	m3/h	
406	float32	Cpp L1	m/s	
407	float32	Cpp L2	m/s	
408	float32	Cpp L3	m/s	
409	float32	Cpp L4	m/s	
410	float32	Cpp L5	m/s	
411	float32	Cpp L6	m/s	
412	float32	Cpp L7	m/s	
413	float32	Cpp L8	m/s	
414	float32	Vpp L1	m/s	
415	float32	Vpp L2	m/s	
416	float32	Vpp L3	m/s	
417	float32	Vpp L4	m/s	
418	float32	Vpp L5	m/s	
419	float32	Vpp L6	m/s	
420	float32	Vpp L7	m/s	
421	float32	Vpp L8	m/s	
422	float32	Spare		
423	float32	SwirlAngle		
424	float32	MeterFactor		

10.7.9 Register map of RMA Ecosonic12 ultrasonic meter

Register address	Data type	Description	Unit	Remark
1100	int32	Tot. volume FR1		
1102	int32	Tot. volume FR2		
1104	int32	Tot. volumeErr FR1		
1106	int32	Tot. volumeErr FR2		
1508	float32	Qm vol. flow rate	m3/h	
1510	float32	Velocity of Gas average	m/s	
1512	float32	SoS average	m/s	
1514	float32	Pressure (mbarA)	mbarA	
1516	float32	Temperature	°C	
1518	float32	Pressure (barA)	barA	
3000	int16	System state		

3001	int16	PT download request		if = 0 not to download PT if <> 0 download PT
3014	int16	AGC Path1 DirA	dB	
3015	int16	AGC Path1 DirB	dB	
3016	int16	AGC Path2 DirA	dB	
3017	int16	AGC Path2 DirB	dB	
3018	int16	AGC Path3 DirA	dB	
3019	int16	AGC Path3 DirB	dB	
3020	int16	AGC Path4 DirA	dB	
3021	int16	AGC Path4 DirB	dB	
3022	int16	AGC Path5 DirA	dB	
3023	int16	AGC Path5 DirB	dB	
3024	int16	AGC Path6 DirA	dB	
3025	int16	AGC Path6 DirB	dB	
3026	float32	Speed of Sound Path1	m/s	
3028	float32	Speed of Sound Path2	m/s	
3030	float32	Speed of Sound Path3	m/s	
3032	float32	Speed of Sound Path4	m/s	
3034	float32	Speed of Sound Path5	m/s	
3036	float32	Speed of Sound Path6	m/s	
3050	float32	Velocity of gas Path1	m/s	
3052	float32	Velocity of gas Path2	m/s	
3054	float32	Velocity of gas Path3	m/s	
3056	float32	Velocity of gas Path4	m/s	
3058	float32	Velocity of gas Path5	m/s	
3060	float32	Velocity of gas Path6	m/s	
3062	float32	SNR Path 1 DirA		
3064	float32	SNR Path 1 DirB		
3066	float32	SNR Path 2 DirA		
3068	float32	SNR Path 2 DirB		
3070	float32	SNR Path 3 DirA		
3072	float32	SNR Path 3 DirB		
3074	float32	SNR Path 4 DirA		
3076	float32	SNR Path 4 DirB		
3078	float32	SNR Path 5 DirA		
3080	float32	SNR Path 5 DirB		
3082	float32	SNR Path 6 DirA		
3084	float32	SNR Path 6 DirB		

3086	int16	Performance Path1	%	
3087	int16	Performance Path2	%	
3088	int16	Performance Path3	%	
3089	int16	Performance Path4	%	
3090	int16	Performance Path5	%	
3091	int16	Performance Path6	%	
1524	float32	Temperature to download (read/write)	°C	
1526	float32	Absolute Pressure (barA) to download (read/write)	barA	

10.7.10 Register map of RMG USZ08 ultrasonic meter

Register address	Data type	Description	Unit	Remark
3000	float64	Tot. volume d1	see 7032	
3004	float64	Tot. volume d2	see 7032	
3008	float64	Tot. volumeErr d1	see 7032	
3012	float64	Tot. volumeErr d2	see 7032	
4000	int16	Fault status		
4001	int16	Warning status		
4040	int16	path-1 status		
4041	int16	path-2 status		
4042	int16	path-3 status		
4043	int16	path-4 status		
4044	int16	path-5 status		
4045	int16	path-6 status		
4046	int16	path-7 status		
4047	int16	path-8 status		
6020	float32	Speed of Sound Path1	m/s	
6022	float32	Speed of Sound Path2	m/s	
6024	float32	Speed of Sound Path3	m/s	
6026	float32	Speed of Sound Path4	m/s	
6028	float32	Speed of Sound Path5	m/s	
6030	float32	Speed of Sound Path6	m/s	
6032	float32	Speed of Sound Path7	m/s	
6034	float32	Speed of Sound Path8	m/s	
6040	float32	p1.1 AGC level	dB	
6042	float32	p2.1 AGC level	dB	
6044	float32	p3.1 AGC level	dB	

6046	float32	p4.1 AGC level	dB	
6048	float32	p5.1 AGC level	dB	
6050	float32	p6.1 AGC level	dB	
6052	float32	p7.1 AGC level	dB	
6054	float32	p8.1 AGC level	dB	
6060	float32	p1.2 AGC level	dB	
6062	float32	p2.2 AGC level	dB	
6064	float32	p3.2 AGC level	dB	
6066	float32	p4.2 AGC level	dB	
6068	float32	p5.2 AGC level	dB	
6070	float32	p6.2 AGC level	dB	
6072	float32	p7.2 AGC level	dB	
6074	float32	p8.2 AGC level	dB	
6200	float32	Velocity vc1	m/s	
6202	float32	Velocity vc2	m/s	
6204	float32	Velocity vc3	m/s	
6206	float32	Velocity vc4	m/s	
6208	float32	Velocity vc5	m/s	
6210	float32	Velocity vc6	m/s	
6212	float32	Velocity vc7	m/s	
6214	float32	Velocity vc8	m/s	
6220	float32	vw (raw gas velocity)	m/s	
6222	float32	vwc (ave. gas velocity)	m/s	
6224	float32	Qm (raw flow rate)	m ³ /h	
6226	float32	Qmc (corr. flow rate)	m ³ /h	
6228	float32	SoS average	m/s	
6230	float32	Qm vol. flow rate		
			m ³ /h	
6264	float32	Qm damped	m ³ /h	
6640	float32	p1.1 SNR	dB	
6642	float32	p2.1 SNR	dB	
6644	float32	p3.1 SNR	dB	
6646	float32	p4.1 SNR	dB	
6648	float32	p5.1 SNR	dB	
6650	float32	p6.1 SNR	dB	
6652	float32	p7.1 SNR	dB	
6654	float32	p8.1 SNR	dB	

6660	float32	p1.2 SNR	dB	
6662	float32	p2.2 SNR	dB	
6664	float32	p3.2 SNR	dB	
6666	float32	p4.2 SNR	dB	
6668	float32	p5.2 SNR	dB	
6670	float32	p6.2 SNR	dB	
6672	float32	p7.2 SNR	dB	
6674	float32	p8.2 SNR	dB	
7000	int16	Valid samples G1		
7001	int16	Valid samples G2		
7002	int16	Valid samples G3		
7003	int16	Valid samples G4		
7004	int16	Valid samples G5		
7005	int16	Valid samples G6		
7006	int16	Valid samples G7		
7007	int16	Valid samples G8		
7030	int16	Velocity unit		0x0000 = m/s 0x0001 = ft/s
7031	int16	Flow rate unit		0x0000 = m3/h 0x0001 = acfh
7032	int16	Volume unit		0x0000 = m3 0x0001 = acf

10.7.11 Register map of Siemens 1010GCGDN ultrasonic meter

Register address	Data type	Description	Unit	Remark
41001	float32	Volume flow rate at line conditions, path 1	m ³ /h	
41003	float32	Volume flow rate at line conditions, path 2	m ³ /h	
41005	float32	Volume flow rate at line conditions	m ³ /h	
41007	float32	Average volume flow rate at line conditions	m ³ /h	
41009	float32	Raw volume flow rate at line conditions, path 1	m ³ /h	
41011	float32	Raw volume flow rate at line conditions, path 2	m ³ /h	
41013	float32	Gas velocity	m/s	
41015	float32	Volume flow totalizer at line conditions	m ³	
41017	float32	Velocity of sound path 1	m/s	
41019	float32	Velocity of sound path 2	m/s	
41021	float32	Average velocity of sound	m/s	
41023	float32	Specific gravity		
41025	float32	Base specific gravity		
41027	float32	Temperature RTD1	°C	

41029	float32	Temperature RTD1	°C	
41031	float32	Delta time path 1	uS	
41033	float32	Delta time path 2	uS	
41035	float32	Analogue input 1		
41037	float32	Analogue input 2		
41039	float32	Analogue input 3		
41041	float32	Analogue input 4		
30001 ...30004	char	Site name		
30005	char	Date		
30007	char	Time		
30009	int16	Signal strength path 1		
30010	int16	Signal strength path 2		
30011	int16	Average signal strength		
30012	int16	Aeration		
30013	int32	Status/Alarm path 1		
30015	int32	Status/Alarm path 2		
30017	int32	Status/Alarm site		

10.7.12 Register map of Sick FLOWSIC-600XT ultrasonic meter

Register address	Data type	Description	Unit	Remark
3196	UINT16	Unit system		
3197	UINT16	Unit system pressure		
3198	UINT16	Unit system temperature		
3199	UINT16	Unit system flow		
3200	UINT16	Global device status		
3201	UINT32	Detailed device status		
4386	SINT16	Resolution operating volume		
4387	UINT32	Operating volume forward undisturbed	m ³ /ft ³	
4389	UINT32	Operating volume reverse undisturbed	m ³ /ft ³	
4391	UINT32	Operating volume forward disturbed	m ³ /ft ³	
4393	UINT32	Operating volume reverse disturbed	m ³ /ft ³	
4395	UINT32	Operating volume forward total	m ³ /ft ³	
4397	UINT32	Operating volume reverse total	m ³ /ft ³	
9388	FLOAT32	Measured flow actual cond.	m ³ /h	
9390	FLOAT32	Measured gas velocity	m/s	
9392	FLOAT32	Measured speed of sound	m/s	
9394	UINT16	Internal status of measurement		
9395	UINT16	Group status of failed path		

9396	UINT16	Consistency check status		
9397	FLOAT32	Temperature for meter body and flow profile correction	°C	
9399	FLOAT32	Pressure for meter body and flow profile correction	bar	
9405	FLOAT32	Path 1-1 gas velocity	m/s	
9407	FLOAT32	Path 1-1 speed of sound	m/s	
9409	UINT16	Path 1-1 acceptance rate	%	
9410	UINT16	Path 1-1 average path status	nincs	
9412	UINT16	Path 1-1 turbulence	%(x100)	
9425	UINT16	Path 1-1SNR A->B	dB(x100)	
9426	UINT16	Path 1-1 SNR B->A	dB(x100)	
9427	UINT16	Path 1-1 AGC A->B	dB(x100)	
9428	UINT16	Path 1-1 AGC B->A	dB(x100)	
9431	FLOAT32	Path 1-2 gas velocity	m/s	
9433	FLOAT32	Path 1-2 speed of sound	m/s	
9435	UINT16	Path 1-2 acceptance rate	%	
9436	UINT16	Path 1-2 average path status	nincs	
9438	UINT16	Path 1-2 turbulence	%(x100)	
9451	UINT16	Path 1-2SNR A->B	dB(x100)	
9452	UINT16	Path 1-2 SNR B->A	dB(x100)	
9453	UINT16	Path 1-2 AGC A->B	dB(x100)	
9454	UINT16	Path 1-2 AGC B->A	dB(x100)	
9457	FLOAT32	Path 1-3 gas velocity	m/s	
9459	FLOAT32	Path 1-3 speed of sound	m/s	
9461	UINT16	Path 1-3 acceptance rate	%	
9462	UINT16	Path 1-3 average path status	nincs	
9464	UINT16	Path 1-3 turbulence	%(x100)	
9477	UINT16	Path 1-3SNR A->B	dB(x100)	
9478	UINT16	Path 1-3 SNR B->A	dB(x100)	
9479	UINT16	Path 1-3 AGC A->B	dB(x100)	
9480	UINT16	Path 1-3 AGC B->A	dB(x100)	
9483	FLOAT32	Path 1-4 gas velocity	m/s	
9485	FLOAT32	Path 1-4 speed of sound	m/s	

9487	UINT16	Path 1-4 acceptance rate	%	
9488	UINT16	Path 1-4 average path status	nincs	
9490	UINT16	Path 1-4 turbulence	%(x100)	
9503	UINT16	Path 1-4SNR A->B	dB(x100)	
9504	UINT16	Path 1-4 SNR B->A	dB(x100)	
9505	UINT16	Path 1-4 AGC A->B	dB(x100)	
9506	UINT16	Path 1-4 AGC B->A	dB(x100)	
9509	FLOAT32	Path 2-1 gas velocity	m/s	
9511	FLOAT32	Path 2-1 speed of sound	m/s	
9513	UINT16	Path 2-1 acceptance rate	%	
9514	UINT16	Path 2-1 average path status	nincs	
9516	UINT16	Path 2-1 turbulence	%(x100)	
9529	UINT16	Path 2-1SNR A->B	dB(x100)	
9530	UINT16	Path 2-1 SNR B->A	dB(x100)	
9531	UINT16	Path 2-1 AGC A->B	dB(x100)	
9532	UINT16	Path 2-1 AGC B->A	dB(x100)	
9535	FLOAT32	Path 2-2 gas velocity	m/s	
9537	FLOAT32	Path 2-2 speed of sound	m/s	
9539	UINT16	Path 2-2 acceptance rate	%	
9540	UINT16	Path 2-2 average path status	nincs	
9542	UINT16	Path 2-2 turbulence	%(x100)	
9555	UINT16	Path 2-2SNR A->B	dB(x100)	
9556	UINT16	Path 2-2 SNR B->A	dB(x100)	
9557	UINT16	Path 2-2 AGC A->B	dB(x100)	
9558	UINT16	Path 2-2 AGC B->A	dB(x100)	
9561	FLOAT32	Path 2-3 gas velocity	m/s	
9563	FLOAT32	Path 2-3 speed of sound	m/s	
9565	UINT16	Path 2-3 acceptance rate	%	
9566	UINT16	Path 2-3 average path status	nincs	
5568	UINT16	Path 2-3 turbulence	%(x100)	
9581	UINT16	Path 2-3SNR A->B	dB(x100)	

9582	UINT16	Path 2-3 SNR B->A	dB(x100)	
9583	UINT16	Path 2-3 AGC A->B	dB(x100)	
9584	UINT16	Path 2-3 AGC B->A	dB(x100)	
9587	FLOAT32	Path 2-4 gas velocity	m/s	
9589	FLOAT32	Path 2-4 speed of sound	m/s	
9591	UINT16	Path 2-4 acceptance rate	%	
9592	UINT16	Path 2-4 average path status	nincs	
9594	UINT16	Path 2-4 turbulence	%(x100)	
9607	UINT16	Path 2-4SNR A->B	dB(x100)	
9608	UINT16	Path 2-4 SNR B->A	dB(x100)	
9609	UINT16	Path 2-4 AGC A->B	dB(x100)	
9610	UINT16	Path 2-4 AGC B->A	dB(x100)	
9613	FLOAT32	Path D-1 gas velocity	m/s	
9615	FLOAT32	Path D-1 speed of sound	m/s	
9617	UINT16	Path D-1 acceptance rate	%	
9618	UINT16	Path D-1 average path status	nincs	
9620	UINT16	Path D-1 turbulence	%(x100)	
9633	UINT16	Path D-1SNR A->B	dB(x100)	
9634	UINT16	Path D-1 SNR B->A	dB(x100)	
9635	UINT16	Path D-1 AGC A->B	dB(x100)	
9636	UINT16	Path D-1 AGC B->A	dB(x100)	
9639	FLOAT32	Path D-2 gas velocity	m/s	
9641	FLOAT32	Path D-2 speed of sound	m/s	
9643	UINT16	Path D-2 acceptance rate	%	
9644	UINT16	Path D-2 average path status	nincs	
9646	UINT16	Path D-2 turbulence	%(x100)	
9659	UINT16	Path D-2SNR A->B	dB(x100)	
9660	UINT16	Path D-2 SNR B->A	dB(x100)	
9661	UINT16	Path D-2 AGC A->B	dB(x100)	
9662	UINT16	Path D-2 AGC B->A	dB(x100)	

10.7.13 Register map of FMC MPU Series B ultrasonic meter

Register address	Data type	Description	Unit	Remark
0	float32	Log count	---	
2	float32	Alarm status	---	
4	float32	Flow velocity	m/s	
6	float32	Velocity of sound	m/s	
8	float32	Actual volume flow rate	m ³ /h	
10	float32	Accumulated volume forward	m ³	
12	float32	Accumulated volume reverse	m ³	
14	float32	Accumulated error volume forward	m ³	
16	float32	Accumulated error volume reverse	m ³	
18	float32	Accumulated time	s	
20	float32	Volume increment	m ³	
22	float32	Increment time duration	s	
24	float32	Used line pressure	barA	
26	float32	Used line temperature	°C	
28	float32	Measured flow velocity path 1	m/s	
30	float32	Measured flow velocity path 2	m/s	
32	float32	Measured flow velocity path 3	m/s	
34	float32	Measured flow velocity path 4	m/s	
36	float32	Measured flow velocity path 5	m/s	
38	float32	Measured flow velocity path 6	m/s	
40	float32	Measured VOS path 1	m/s	
42	float32	Measured VOS path 2	m/s	
44	float32	Measured VOS path 3	m/s	
46	float32	Measured VOS path 4	m/s	
48	float32	Measured VOS path 5	m/s	
50	float32	Measured VOS path 6	m/s	
52	float32	Percentage of burst used transducer 1A	%	
54	float32	Percentage of burst used transducer 2A	%	
56	float32	Percentage of burst used transducer 3A	%	
58	float32	Percentage of burst used transducer 4A	%	
60	float32	Percentage of burst used transducer 5A	%	
62	float32	Percentage of burst used transducer 6A	%	
64	float32	Percentage of burst used transducer 6B	%	
66	float32	Percentage of burst used transducer 5B	%	
68	float32	Percentage of burst used transducer 4B	%	
70	float32	Percentage of burst used transducer 3B	%	
72	float32	Percentage of burst used transducer 2B	%	
74	float32	Percentage of burst used transducer 1B	%	
76	float32	Gain transducer 1A	%	

78	float32	Gain transducer 2A	%	
80	float32	Gain transducer 3A	%	
82	float32	Gain transducer 4A	%	
84	float32	Gain transducer 5A	%	
86	float32	Gain transducer 6A	%	
88	float32	Gain transducer 6B	%	
90	float32	Gain transducer 5B	%	
92	float32	Gain transducer 4B	%	
94	float32	Gain transducer 3B	%	
96	float32	Gain transducer 2B	%	
98	float32	Gain transducer 1B	%	

10.7.14 Register map of ABB NGC820X gas chromatograph

Register number	Data type	Description	Unit	Remark
3034	int16	Stream last analyzed		
3041	int16	Start of cycle month		
3042	int16	Start of cycle day		
3043	int16	Start of cycle year		
3044	int16	Start of cycle hour		
3045	int16	Start of cycle minute		
3058	int16	New data flag		
3059	int16	Analysis/calibration flag		
3061	int16	Stream last analyzed		
7001	float32	Propane	mole%	
7002	float32	I-butane	mole%	
7003	float32	N-butane	mole%	
7004	float32	Neo-pentane	mole%	
7005	float32	I-pentane	mole%	
7006	float32	N-pentane	mole%	
7007	float32	C6+	mole%	
7008	float32	Nitrogen	mole%	
7009	float32	Methane	mole%	
7010	float32	Carbon-dioxide	mole%	
7011	float32	Ethane	mole%	
7012	float32	Hexane	mole%	
7013	float32	Heptane	mole%	

7014	float32	Octane	mole%	
7015	float32	Nonane	mole%	
7033	float32	Superior heating value	MJ/m ³	
7034	float32	Inferior heating value	MJ/m ³	
7035	float32	Relative density	--	

10.7.15 Register map of ABB2 gas chromatograph

Register number	Data type	Description	Unit	Remark
30001	int16	Stream 1 sample time		
30002	int16	Stream 1 sample time		
30003	int16	Stream 1 sample time		
30004	int16	Stream 1 Hydrogen	mole %	
30005	int16	Stream 1 I-butane	mole %	
30006	int16	Stream 1 N-butane	mole %	
30007	int16	Stream 1 1,3-butadiene	mole %	
30008	int16	Stream 1 Total C5	mole %	
30009	int16	Stream 1 Total C6	mole %	
30010	int16	Stream 2 sample time		
30011	int16	Stream 2 sample time		
30012	int16	Stream 2 sample time		
30014	int16	Stream 2 I-butane	mole %	
30015	int16	Stream 2 N-butane	mole %	
30016	int16	Stream 2 1,3-butadiene	mole %	
30017	int16	Stream 2 Total C5	mole %	
30018	int16	Stream 2 Total C6	mole %	
30021	int16	Stream 21 Air with nitrogen	mole %	
30022	int16	Stream 21 Methane	mole %	
30023	int16	Stream 21 CO2	mole %	
30024	int16	Stream 21 Ethylene	mole %	
30025	int16	Stream 21 Ethane	mole %	
30026	int16	Stream 21 Propylene	mole %	
30027	int16	Stream 21 Propadiene	mole %	
30031	int16	Stream 22 Air with nitrogen	mole %	
30032	int16	Stream 22 Methane	mole %	
30033	int16	Stream 22 CO2	mole %	
30034	int16	Stream 22 Ethylene	mole %	

30035	int16	Stream 22 Ethane	mole %	
30036	int16	Stream 22 Propylene	mole %	
30037	int16	Stream 22 Propadiene	mole %	

10.7.16 Register map of Daniel Danalyzer C6+ gas chromatograph

Register number	Data type	Description	Unit	Remark
3034	int16	Stream last analysed		
3041	int16	Start of cycle month		
3042	int16	Start of cycle day		
3043	int16	Start of cycle year		
3044	int16	Start of cycle hour		
3045	int16	Start of cycle minute		
3058	int16	New data flag		
3059	int16	Analysis/calibration flag		
3061	int16	Stream last analyzed		
7001	float32	C6+	mole%	
7002	float32	Propane	mole%	
7003	float32	I-butane	mole%	
7004	float32	N-butane	mole%	
7005	float32	Neo-pentane	mole%	
7006	float32	I-pentane	mole%	
7007	float32	N-pentane	mole%	
7008	float32	Nitrogen	mole%	
7009	float32	Methane	mole%	
7010	float32	Carbon-dioxide	mole%	
7011	float32	Ethane	mole%	
7012	float32	Hydrogen	mole%	
7013	float32	Helium	mole%	
7033	float32	Superior heating value	MJ/m ³	
7035	float32	Relative density	--	
7087	float32	Inferior heating value	MJ/m ³	

10.7.17 Register map of Daniel Danalyzer C9+ gas chromatograph

Register number	Data type	Description	Unit	Remark
3034	int16	Stream last analysed		
3041	int16	Start of cycle month		
3042	int16	Start of cycle day		
3043	int16	Start of cycle year		
3044	int16	Start of cycle hour		
3045	int16	Start of cycle minute		
3058	int16	New data flag		
3059	int16	Analysis/calibration flag		
3061	int16	Stream last analysed		
7001	float32	Propane	mole%	
7002	float32	I-butane	mole%	
7003	float32	N-butane	mole%	
7004	float32	I-pentane	mole%	
7005	float32	N-pentane	mole%	
7006	float32	Nitrogen	mole%	
7007	float32	Methane	mole%	
7008	float32	Carbon-dioxide	mole%	
7009	float32	Ethane	mole%	
7010	float32	C9plus	mole%	
7011	float32	Hexane	mole%	
7012	float32	Heptane	mole%	
7013	float32	Octane	mole%	
7014	float32	Hydrogen	mole%	
7015	float32	Helium	mole%	
7033	float32	Superior heating value	MJ/m ³	
7035	float32	Relative density	--	
7087	float32	Inferior heating value	MJ/m ³	

10.7.18 Register map of Yamatake HGC gas chromatograph

Register number	Data type	Description	Unit	Remark

3034	int16	Stream last analysed		
3041	int16	Start of cycle month		
3042	int16	Start of cycle day		
3043	int16	Start of cycle year		
3044	int16	Start of cycle hour		
3045	int16	Start of cycle minute		
3058	int16	New data flag		
3059	int16	Analysis/calibration flag		
3061	int16	Stream last analyzed		
7001	float32	C6+	mole%	
7002	float32	Propane	mole%	
7003	float32	I-butane	mole%	
7004	float32	N-butane	mole%	
7005	float32	Neo-pentane	mole%	
7006	float32	I-pentane	mole%	
7007	float32	N-pentane	mole%	
7008	float32	Nitrogen	mole%	
7009	float32	Methane	mole%	
7010	float32	Carbon-dioxide	mole%	
7011	float32	Ethane	mole%	
7033	float32	Superior heating value	MJ/m ³	
7035	float32	Relative density	--	
7087	float32	Inferior heating value	MJ/m ³	

10.7.19 Register map of Yokogawa gas chromatograph

Register number	Data type	Description	Unit	Remark
41001	float32	C6+ stream 1	mole%	
41003	float32	Propane stream 1	mole%	
41005	float32	I-butane stream 1	mole%	
41007	float32	N-butane stream 1	mole%	
41009	float32	I-pentane stream 1	mole%	
41011	float32	N-pentane stream 1	mole%	
41013	float32	Nitrogen stream 1	mole%	
41015	float32	Methane stream 1	mole%	

41017	float32	Carbon-dioxide stream 1	mole%	
41019	float32	Ethane stream 1	mole%	
41021	float32	C6+ stream 2	mole%	
41023	float32	Propane stream 2	mole%	
41025	float32	I-butane stream 2	mole%	
41027	float32	N-butane stream 2	mole%	
41029	float32	I-pentane stream 2	mole%	
41031	float32	N-pentane stream 2	mole%	
41033	float32	Nitrogen stream 2	mole%	
41035	float32	Methane stream 2	mole%	
41037	float32	Carbon-dioxide stream 2	mole%	
41039	float32	Ethane stream 2	mole%	
41041	float32	C6+ stream 3	mole%	
41043	float32	Propane stream 3	mole%	
41045	float32	I-butane stream 3	mole%	
41047	float32	N-butane stream 3	mole%	
41049	float32	I-pentane stream 3	mole%	
41051	float32	N-pentane stream 3	mole%	
41053	float32	Nitrogen stream 3	mole%	
41055	float32	Methane stream 3	mole%	
41057	float32	Carbon-dioxide stream 3	mole%	
41059	float32	Ethane stream 3	mole%	
41061	float32	C6+ stream 4	mole%	
41063	float32	Propane stream 4	mole%	
41065	float32	I-butane stream 4	mole%	
41067	float32	N-butane stream 4	mole%	
41069	float32	I-pentane stream 4	mole%	
41071	float32	N-pentane stream 4	mole%	
41073	float32	Nitrogen stream 4	mole%	
41075	float32	Methane stream 4	mole%	
41077	float32	Carbon-dioxide stream 4	mole%	
41079	float32	Ethane stream 4	mole%	

10.7.20 Register map of Elster EnCal3000 gas chromatograph

Register number	Data type	Description	Unit	Remark
6991	int32	Instrument State	mole%	
6992	int32	Current Sequence State	mole%	
6993	int32	Current Sample Type	mole%	
6994	int32	Current running time	mole%	
6995	int32	Calibration Alarm	mole%	
6996	int32	Current Stream Position	mole%	

6997	int32	Current Stream Analysing	mole%	
6998	int32	Stream Position	mole%	
7048	float32	Year of Injection	mole%	
7049	float32	Month of Injection	mole%	
7050	float32	Day of Injection	mole%	
7051	float32	Hour of Injection	mole%	
7052	float32	Minute of Injection	mole%	
7053	float32	Second of Injection	mole%	

Register number, Str1 data	Register number, Str2 data	Register number, Str3 data	Register number, Str4 data	Data type	Description
7000	7200	7300	7400	float32	Nitrogen
7001	7201	7301	7401	float32	Methane
7002	7202	7302	7402	float32	Carbon-dioxide
7003	7203	7303	7403	float32	Ethane
7004	7204	7304	7404	float32	Hydrogen-sulphide
7005	7205	7305	7405	float32	Carbonyl-sulphide
7006	7206	7306	7406	float32	Propane
7007	7207	7307	7407	float32	I-butane
7008	7208	7308	7408	float32	N-butane
7009	7209	7309	7409	float32	Neo-pentane
7010	7210	7310	7410	float32	I-pentane
7011	7211	7311	7411	float32	N-pentane
7012	7212	7312	7412	float32	N-hexane
7013	7213	7313	7413	float32	N-heptane
7014	7214	7314	7414	float32	N-octane
7015	7215	7315	7415	float32	N-nonane
7016	7216	7316	7416	float32	N-decane
7017	7217	7317	7417	float32	GCV
7018	7218	7318	7418	float32	Relative density
7019	7219	7319	7419	float32	Compression factor
7020	7220	7320	7420	float32	Wobbe-index (GCV)
7021	7221	7321	7421	float32	NCV
7022	7222	7322	7422	float32	Wobbe-index (NCV)
7023	7223	7323	7423	float32	Base density
7024	7224	7324	7424	float32	Alarm status
7026	7226	7326	7426	float32	Benzene
7026	7226	7326	7426	float32	Cyclo-hexane
7027	7227	7327	7427	float32	Methyl-cyclo-hexane
7028	7228	7328	7428	float32	Toluene

7029	7229	7329	7429	float32	N-undecane
7030	7230	7330	7430	float32	N-dodecane
7031	7231	7331	7431	float32	Oxygen
7032	7232	7332	7432	float32	Hydrogen
7033	7233	7333	7433	float32	Helium

10.7.21 Register map of Emerson 3095FB multiparameter transmitter

Register number	Data type	Description	Unit	Remark
3	coil	Calibration flag		
31	coil	Restore factory default setting for DP		
32	coil	Restore factory default setting for SP		
33	coil	Restore factory default setting for PT		
51	coil	Transmitter critical alarm		
52	coil	Transmitter warning		
401	float32	DP (differential pressure)		
403	float32	SP (static pressure)		
405	float32	PT (temperature)		
437	float32	DP offset		
439	float32	DP span		
441	float32	DP damping		
443	float32	SP offset		
445	float32	SP span		
447	float32	SP damping		
449	float32	PT offset		
451	float32	PT span		
453	float32	PT damping		

10.7.22 Register map of Krohne MFC300 mass flow meter transmitter

Register number	Data type	Description	Unit	Remark
30000	float32	Flow Velocity	m/s	
30002	float32	Volume Flow	m ³ /h	see note
30004	float32	Mass Flow	kg/h	see note
30006	float32	Temperature	°C	see note
30008	float32	Density	kg/m ³	see note
30010	float32	Concentration 1		

30012	float32	Concentration 2 or Diagnosis 3		
30014	float32	Concentration Flow 1		
30016	float32	Concentration Flow 2		
30018	float32	Diagnosis 1		
30020	float32	Diagnosis 2		
30022	float32	Display Channel 1 Represents the value on the first line of the first measurement screen in SI units		
30024	float32	Display Channel 2 Represents the value on the first line of the second measurement screen in SI units		
30026	float32	Operating time	s	
30050	float64	Counter 1	m ³ or kg	see note
30054	float64	Counter 2	m ³ or kg	see note
30058	float64	Counter 3 Note: this counter is only available for converter with IO2!	m ³ or kg	see note
30062	byte4	Long Status Sensor		
30064	byte4	Long Status Device		

NOTE:

- Unit of volume flow must be set to m³/h and the unit of mass flow must be set to kg/h.
- Mass flow, density and temperature are assigned to internal Modbus registers of the flow computer. These Modbus registers then shall be configured as Modbus signals and can be utilized in stream setup as input signals for flow calculation.
- Units of Counters 1, 2, 3 are depending on the settings in FMC300.

10.7.23 Register map of Emerson Micromotion mass flow meter

Register number	Data type	Description	Unit	Remark
39	int16	Standard or special mass flow unit		
40	int16	Density unit		
41	int16	Temperature unit		
42	int16	Standard or special volume unit		
43	int16	Pressure unit		
45	int16	Standard or special mass total or inventory unit		
46	int16	Standard or special volume total or inventory unit		
247	float32	Mass flow rate		
249	float32	Density		see note
251	float32	Temperature		see note
253	float32	Volume flow rate		
257	float32	Pressure (internally derived)		see note
259	float32	Mass total		
261	float32	Volume total		

263	float32	Mass inventory		
265	float32	Volume inventory		
422	int16	bit4 flow direction		

NOTE: Mass flow, density, pressure and temperature are assigned to internal Modbus registers of the flow computer. These Modbus registers then shall be configured as Modbus signals and can be utilized in stream setup as input signals for flow calculation.

Annex A. Reports

Archive reports naming conventions

The archive report files can be transferred from the UNIFLOW-200 to external device in two ways.

- reports are transferred to serial or USB ports from the menu Flow - > Data transfer.
- reports are read by UNIArchive program.

The naming convention for the reports and report file names is as follows.

Content of the report	Report name on the Flow - > Data transfer menu	File name in UNIArchive
Limited set of daily data for the current month	Month (daily short) (month shall be selected in separate field, previous 12 month data are available for selection)	<i>nrstr_streamname_yyyy_mm_dd_daily.txt</i> Example: 01str_M123_2013_04_12_daily.txt
Limited set of daily data for the previous months		<i>nrstr_streamname_yyyy_mm_daily.txt</i> Example: 01str_M123_2013_03_daily.txt
Limited set of hourly data for the current month	Month (hourly short) (month shall be selected in separate field, previous 12 month data are available for selection)	<i>nrstr_streamname_yyyy_mm_dd_hourly.txt</i> Example: 01str_M123_2013_04_12_hourly.txt
Limited set of hourly data for the previous months		<i>nrstr_streamname_yyyy_mm_hourly.txt</i> Example: 01str_M123_2013_03_hourly.txt
User defined set No.1 of daily data for the current month	Month (daily defined 1) (month shall be selected in separate field, previous 12 month data are available for selection)	<i>01rp_yyyy_mm_dd_daily.txt</i> Example: 01rp_2013_04_12_daily.txt
User defined set No.1 of daily data for the previous month		<i>01rp_yyyy_mm_daily.txt</i> Example: 01rp_2013_03_daily.txt
User defined set No.1 of hourly data for the current month	Month (hourly defined 1) (month shall be selected in separate field, previous 12 month data are available for selection)	<i>01rp_yyyy_mm_dd_hourly.txt</i> Example: 01rp_2013_04_12_hourly.txt
User defined set No.1 of hourly data for the previous month		<i>01rp_yyyy_mm_hourly.txt</i> Example: 01rp_2013_03_hourly.txt
User defined set No.2 of daily data for the current month	Month (daily defined 2) (month shall be selected in separate field, previous 12 month data are available for selection)	<i>02rp_yyyy_mm_dd_daily.txt</i> Example: 02rp_2013_04_12_daily.txt
User defined set No.2 of daily data for the previous month		<i>02rp_yyyy_mm_daily.txt</i> Example: 02rp_2013_03_daily.txt
User defined set No.2 of hourly data for the current month	Month (hourly defined 2) (month shall be selected in separate field, previous 12 month data are available for selection)	<i>02rp_yyyy_mm_dd_hourly.txt</i> Example: 02rp_2013_04_12_hourly.txt
User defined set No.2 of hourly data for the previous month		<i>02rp_yyyy_mm_hourly.txt</i> Example: 02rp_2013_03_hourly.txt
Hourly data for the indicated month for stream <i>nn</i>	Month (hourly) (month and stream shall be selected in separate field)	<i>yyyy_mm_month_hourly_nrstr.txt</i> Example: 2013_04_month_hourly_01str.txt
Shift data for the indicated month for all 12 streams	Month (shift) (month shall be selected in separate field)	<i>yyyy_mm_month_shift.txt</i> Example: 2013_04_month_shift.txt
Daily data for the indicated month for all 12 streams	Month (daily) (month shall be selected in separate field)	<i>yyyy_mm_month_daily.txt</i> Example: 2013_04_month_daily.txt
Multiday data for the indicated month for all 12 streams	Month (multiday) (month shall be selected in separate field)	<i>yyyy_mm_month_multiday.txt</i> Example: 2013_04_month_multiday.txt
Monthly data for the indicated year for all 12 streams	Year (monthly) (year shall be selected in separate field)	<i>yyyy_monthly.txt</i> Example: 2013_monthly.txt

Alarm log	Logs (all four logs transferred)	alarmlog.txt
Event log		eventlog.txt
Project log		projectlog.txt
Downloaded gas composition		downloadlog.txt
Monthly batch data for the selected month	Monthly batches	batch.txt
Meter serial test data. The last 10 serial test reports are stored.	Meter serial test	Meter_serial_test_report.txt
Flow computer test data. The last 10 serial test reports are stored.	FC calibration report	Flow_computer_test_report.txt
Limited set of hourly data for the current day. The content of the report is identical with the Month (hourly short) report but data included for the previous day only.	Prev. day (hourly short) (stream shall be selected in separate field)	<i>nrstrd_streamname_previous_day_hourly.txt</i> Example: 01strd_M123_previous_day_hourly.txt
Limited set of hourly data for the previous day. The content of the report is identical with the Month (hourly short) report but data included for the current day only.	Cur. day (hourly short) (stream shall be selected in separate field)	<i>nrstrd_streamname_yyyy_mm_dd_hourly.txt</i> Example: 01strd_M123_2013_04_12_hourly.txt
User defined set No.1 of hourly data for the previous day. The content of the report is identical with the Month (hourly defined 1) report but data included for the previous day only.	Prev. day (hourly defined 1)	01rpd_previous_day_hourly.txt Example: 01rpd_previous_day_hourly.txt
User defined set No.1 of hourly data for the current day. The content of the report is identical with the Month (hourly defined 1) report but data included for the current day only.	Cur. day (hourly defined 1)	01rpd_yyyyy_mm_dd_hourly.txt Example: 01rpd_2013_04_12_hourly.txt
User defined set No.2 of hourly data for the previous day. The content of the report is identical with the Month (hourly defined 2) report but data included for the previous day only.	Prev. day (hourly defined 2)	02rpd_previous_day_hourly.txt Example: 02rpd_previous_day_hourly.txt
User defined set No.2 of hourly data for the current day. The content of the report is identical with the Month (hourly defined 2) report but data included for the current day only.	Cur. day (hourly defined 2)	02rpd_yyyyy_mm_dd_hourly.txt 02rpd_2013_04_12_hourly.txt
User defined set No.3 of hourly data for the previous day.	Prev. day (hourly defined 3)	03rpds_previous_day_hourly.txt Example: 03rpds_previous_day_hourly.txt
User defined set No.3 of hourly data for the current day.	Cur. day (hourly defined 3)	03rpds_yyyy_mm_dd_hourly.txt Example: 03rpds_2013_04_12_hourly.txt
User defined set No.4 to 10 of hourly data for the previous day.	Prev. day (hourly defined 4 to 10)	04 to 10rpds_previous_day_hourly.txt Example: 05rpds_previous_day_hourly.txt
User defined set No.4 to 10 of hourly data for the current day.	Cur. day (hourly defined 4 to 10)	04 to 10rpds_yyyy_mm_dd_hourly.txt Example: 05rpds_2013_04_12_hourly.txt

		<p>where: <i>nn</i> – stream number <i>yyyy</i> – year <i>mm</i> – month <i>dd</i> – day <i>streamname</i> – stream name as entered in the Parameters -> Stream -> Physical stream and Parameters -> Stream -> Virtual stream menu</p>
--	--	--

Month (daily short) report example

```

=====
Month (daily short)
Previous month flows in daily details 2013.07.01 06:00 -
=====
11PTYXY
=====
Type of flowmeter: Turbine flowmeter
Machine: UNIFLOW-200 MFC_200-063
Branch: Tarif_1 2.str.

Time UVOL CVOL Energy P_avg. T_avg. K_avg. Inf.c.v
- m3 Sm3 GJ barA oC - MJ/m3
2013/06/02 06:00 683941 7686908 261474 26.005 380.00 1.0074 34.016
2013/06/03 06:00 683925 7686730 261469 26.005 380.00 1.0074 34.016
2013/06/04 06:00 683933 7686818 261472 26.005 380.00 1.0074 34.016
2013/06/05 06:00 683934 7686819 261471 26.005 380.00 1.0074 34.016
2013/06/06 06:00 681336 7657637 260478 26.005 380.00 1.0074 34.016
2013/06/07 06:00 17011 191192 6504 26.005 380.00 1.0074 34.016
2013/06/08 06:00 683819 7685529 261428 26.005 380.00 1.0074 34.016
2013/06/09 06:00 55858 627801 21355 26.005 380.00 1.0074 34.016
2013/06/10 06:00 0 0 0 26.005 380.00 1.0074 34.016
2013/06/11 06:00 * * * * * * *
2013/06/12 06:00 * * * * * * *
2013/06/13 06:00 * * * * * * *
2013/06/14 06:00 * * * * * * *
2013/06/15 06:00 * * * * * * *
2013/06/16 06:00 * * * * * * *
2013/06/17 06:00 * * * * * * *
2013/06/18 06:00 * * * * * * *
2013/06/19 06:00 * * * * * * *
2013/06/20 06:00 * * * * * * *
2013/06/21 06:00 * * * * * * *
2013/06/22 06:00 * * * * * * *
2013/06/23 06:00 * * * * * * *
2013/06/24 06:00 * * * * * * *
2013/06/25 06:00 * * * * * * *
2013/06/26 06:00 * * * * * * *
2013/06/27 06:00 * * * * * * *
2013/06/28 06:00 * * * * * * *
2013/06/29 06:00 * * * * * * *
2013/06/30 06:00 * * * * * * *
2013/07/01 06:00 0 0 0 26.005 380.00 1.0074 34.016

Previous month flows
UVOL: 4173757 m3
CVOL: 46909434 Sm3
Energy: 1595651 GJ
Premium CVOL: 0 Sm3

Previous month averages
P_average: 26.0050 bar
T_average: 380.0000 °C
K_average: 1.0074 -

Previous month maximal hourly corrected volume
CVOL_hourly_max: 320285 Sm3
Max_month: 6 month
Max_day: 1 day
Max_hour: 12 hour

Previous month
Flow time: 188.3019 hours
Fault flow time: 146.4619 hours
=====
02str_Tarif_1_2013_06_daily.txt

```

Month (hourly short)report example

```

=====
Month (hourly short)
Previous month flows in hourly details 2013.07.01 06:00 -
=====
11PTYXY

=====
Type of flowmeter: Turbine flowmeter
Machine: UNIFLOW-200 MFC_200-063
Branch: Tarif_1 2.str.

Time UVOL CVOL Energy P_avg. T_avg. K_avg. Inf.c.v
- m3 Sm3 GJ barA oC - MJ/m3
2013/06/01 07:00 28497 320284 10895 26.005 380.00 1.0074 34.016
2013/06/01 08:00 28497 320284 10894 26.005 380.00 1.0074 34.016
2013/06/01 09:00 28498 320284 10895 26.005 380.00 1.0074 34.016
2013/06/01 10:00 28497 320284 10894 26.005 380.00 1.0074 34.016
2013/06/01 11:00 28497 320284 10895 26.005 380.00 1.0074 34.016
2013/06/01 12:00 28497 320285 10895 26.005 380.00 1.0074 34.016
2013/06/01 13:00 28497 320284 10894 26.005 380.00 1.0074 34.016
2013/06/01 14:00 28498 320284 10895 26.005 380.00 1.0074 34.016
2013/06/01 15:00 28497 320284 10895 26.005 380.00 1.0074 34.016
2013/06/01 16:00 28497 320284 10894 26.005 380.00 1.0074 34.016
2013/06/01 17:00 28497 320284 10895 26.005 380.00 1.0074 34.016
2013/06/01 18:00 28497 320284 10895 26.005 380.00 1.0074 34.016
2013/06/01 19:00 28498 320284 10894 26.005 380.00 1.0074 34.016
2013/06/01 20:00 28497 320284 10895 26.005 380.00 1.0074 34.016
2013/06/01 21:00 28497 320285 10895 26.005 380.00 1.0074 34.016
2013/06/01 22:00 28497 320284 10894 26.005 380.00 1.0074 34.016
2013/06/01 23:00 28498 320284 10895 26.005 380.00 1.0074 34.016
2013/06/02 00:00 28497 320284 10895 26.005 380.00 1.0074 34.016
2013/06/02 01:00 28497 320284 10894 26.005 380.00 1.0074 34.016
2013/06/02 02:00 28497 320284 10895 26.005 380.00 1.0074 34.016
2013/06/02 03:00 28497 320284 10894 26.005 380.00 1.0074 34.016
2013/06/02 04:00 28498 320284 10895 26.005 380.00 1.0074 34.016
2013/06/02 05:00 28497 320285 10895 26.005 380.00 1.0074 34.016
...
2013/06/30 07:00 * * * * * * *
2013/06/30 08:00 * * * * * * *
2013/06/30 09:00 * * * * * * *
2013/06/30 10:00 * * * * * * *
2013/06/30 11:00 * * * * * * *
2013/06/30 12:00 * * * * * * *
2013/06/30 13:00 * * * * * * *
2013/06/30 14:00 * * * * * * *
2013/06/30 15:00 * * * * * * *
2013/06/30 16:00 * * * * * * *
2013/06/30 17:00 * * * * * * *
2013/06/30 18:00 * * * * * * *
2013/06/30 19:00 * * * * * * *
2013/06/30 20:00 * * * * * * *
2013/06/30 21:00 * * * * * * *
2013/06/30 22:00 * * * * * * *
2013/06/30 23:00 * * * * * * *
2013/07/01 00:00 * * * * * * *
2013/07/01 01:00 * * * * * * *
2013/07/01 02:00 * * * * * * *
2013/07/01 03:00 * * * * * * *
2013/07/01 04:00 * * * * * * *
2013/07/01 05:00 * * * * * * *
2013/07/01 06:00 0 0 0 26.005 380.00 1.0074 34.016
=====
02str_Tarif_1_2013_06_hourly.txt
=====

```

Periodic print: Cur. Day (hourly short) report example

```

=====
Prev. Day (hourly short)
Previous day flows in hourly details 2013.07.01 06:00 -
=====
11PTYXY

=====
Type of flowmeter: Nozzle
Machine: UNIFLOW-200 MFC_200-063

```

Branch: STO 1.str.

Time	UVOL	CVOL	Energy	P_avg.	T_avg.	K_avg.	Inf.c.v
-	MCF	SMCF	MMBTU	PSIA	oF	-	BTU/SCF
2013/06/30 07:00	*	*	*	*	*	*	*
2013/06/30 08:00	*	*	*	*	*	*	*
2013/06/30 09:00	*	*	*	*	*	*	*
2013/06/30 10:00	*	*	*	*	*	*	*
2013/06/30 11:00	*	*	*	*	*	*	*
2013/06/30 12:00	*	*	*	*	*	*	*
2013/06/30 13:00	*	*	*	*	*	*	*
2013/06/30 14:00	*	*	*	*	*	*	*
2013/06/30 15:00	*	*	*	*	*	*	*
2013/06/30 16:00	*	*	*	*	*	*	*
2013/06/30 17:00	*	*	*	*	*	*	*
2013/06/30 18:00	*	*	*	*	*	*	*
2013/06/30 19:00	*	*	*	*	*	*	*
2013/06/30 20:00	*	*	*	*	*	*	*
2013/06/30 21:00	*	*	*	*	*	*	*
2013/06/30 22:00	*	*	*	*	*	*	*
2013/06/30 23:00	*	*	*	*	*	*	*
2013/07/01 00:00	*	*	*	*	*	*	*
2013/07/01 01:00	*	*	*	*	*	*	*
2013/07/01 02:00	*	*	*	*	*	*	*
2013/07/01 03:00	*	*	*	*	*	*	*
2013/07/01 04:00	*	*	*	*	*	*	*
2013/07/01 05:00	*	*	*	*	*	*	*
2013/07/01 06:00	4	51	46	174.05	57.20	0.9780	897.68

Previous day flows

UVOL: 4 SMCF
 CVOL: 52 MCF
 Energy: 46 MMBTU
 Premium CVOL: 0 MCF

Previous day averages

P_average: 174.0453 PSIA
 T_average: 57.2000 oF
 K_average: 0.9780 -

Previous day maximal hourly corrected volume

CVOL_hourly_max: 0 MCF
 Max_month: 0 month
 Max_day: 0 day
 Max_hour: 0 hour

Previous day

Flow time: 0.0190 hours
 Fault flow time: 0.0190 hours

=====
 01strd_STO_previous_day_hourly.txt
 =====

Periodic print: Prev. Day (hourly defined 1) report example

```

=====
                Previous day, hourly defined rep.2
                Previous day flows in hourly details 2013.07.01 06:00 -
=====
11PTYXY

=====
Machine:                UNIFLOW-200 MFC_200-063

Time                    -   1.Str   2.Str   3.Str   4.Str   -
                        -   CVOL   CVOL   CVOL   CVOL   -
                        -   m3     m3     m3     m3     -
2013/06/30 07:00       1234   5678   9012   3456
2013/06/30 08:00       1234   5678   9012   3456
2013/06/30 09:00       1234   5678   9012   3456
2013/06/30 10:00       1234   5678   9012   3456
2013/06/30 11:00       1234   5678   9012   3456
2013/06/30 12:00       1234   5678   9012   3456
2013/06/30 13:00       1234   5678   9012   3456
2013/06/30 14:00       1234   5678   9012   3456
2013/06/30 15:00       1234   5678   9012   3456
2013/06/30 16:00       1234   5678   9012   3456
2013/06/30 17:00       1234   5678   9012   3456
2013/06/30 18:00       1234   5678   9012   3456
2013/06/30 19:00       1234   5678   9012   3456
2013/06/30 20:00       1234   5678   9012   3456
2013/06/30 21:00       1234   5678   9012   3456
2013/06/30 22:00       1234   5678   9012   3456
2013/06/30 23:00       1234   5678   9012   3456
2013/07/01 00:00       1234   5678   9012   3456
2013/07/01 01:00       1234   5678   9012   3456
2013/07/01 02:00       1234   5678   9012   3456
2013/07/01 03:00       1234   5678   9012   3456
2013/07/01 04:00       1234   5678   9012   3456
2013/07/01 05:00       1234   5678   9012   3456
2013/07/01 06:00       1234   5678   9012   3456
=====
02rpd_previous_day_hourly.txt
=====

```

Periodic print: Prev. Day (hourly defined 3) report example

=====
 Daily billing report (User report 3)
 Flows in hourly details Printed: 2013.07.02 06:00 -
 =====

11PTYXY

Meter Location: SH2

=====
 Machine: UNIFLOW-200 MFC_200-063
 Gas Day :2013/07/01
 Contract Time: 6
 Meter Tube Inside Diam: 7.874016 inches Orifice Plate Diam. : 3.937008 inches
 VOLUME factor: 28.000000
 Run Time : 23.055694 GC updates : 0
 Alarms : 24
 Events : 10

C1=98.259332 C2=0.000000 C3=0.000000 IC4=0.000000 NC4=0.000000
 H2O=1.740665 IC5=0.000000 NC5=0.000000 C6+=0.000000 CO2=0.000000 N2=0.000000

	1.Str	1.Str	1.Str	1.Str
	UVOL	CVOL	MASS	Energy
	MCF	MCF	lb	MMBTU
Previous Day Total	: 0	0	0	0
Current Day Total	: 1772	50137	3131172	45007
Cumulative Total	: 55885	2219188	104427317	2174591

	1.Str	1.Str	1.Str	1.Str	1.Str	1.Str	1.Str
	P avg	Temp.a	dp avg	K avg	Sup.c.v	Rel.dens	l.dens.a
	PSIA	°F	inchH2O	-	BTU/SCF	-	lb/CF
GasDayMax.	633.440	50.97	175.0432	0.9131	997.95	0.5562	2.992
Min.	174.045	50.95	174.9975	0.9131	997.95	0.5562	0.758
Avg.	525.232	52.43	545.5416	0.9284	997.95	0.5562	2.466

Time	1.Str	1.Str	1.Str	1.Str	1.Str	1.Str	1.Str	1.Str
hour	UVOL	CVOL	MASS	Energy	P avg	Temp.a	Sup.c.v	F.time
	MCF	MCF	lb	MMBTU	PSIA	°F	BTU/SCF	h
06-07	13	167	10469	150	174.045	57.20	997.95	0.0611
07-08	225	2743	171307	2462	174.045	57.20	997.95	1.0000
08-09	225	2740	171144	2459	174.045	57.20	997.95	0.9990
09-10	225	2742	171305	2462	174.045	57.20	997.95	1.0000
10-11	225	2742	171301	2462	174.045	57.20	997.95	1.0000
11-12	86	2186	136521	1961	492.628	52.88	997.95	0.9958
12-13	42	2045	127738	1835	633.441	50.97	997.95	1.0000
13-14	42	2045	127735	1835	633.428	50.97	997.95	1.0000
14-15	42	2045	127733	1836	633.411	50.97	997.95	1.0000
15-16	42	2045	127729	1835	633.395	50.96	997.95	1.0000
16-17	42	2045	127727	1835	633.381	50.96	997.95	1.0000
17-18	42	2045	127724	1835	633.376	50.96	997.95	1.0000
18-19	42	2045	127724	1835	633.372	50.96	997.95	1.0000
19-20	42	2045	127724	1835	633.371	50.96	997.95	1.0000
20-21	42	2044	127709	1834	633.381	50.96	997.95	0.9999
21-22	42	2045	127727	1835	633.383	50.96	997.95	1.0000
22-23	42	2045	127731	1835	633.398	50.96	997.95	1.0000
23-00	42	2045	127731	1836	633.407	50.97	997.95	1.0000
00-01	42	2045	127735	1835	633.422	50.97	997.95	1.0000
01-02	42	2045	127733	1835	633.418	50.97	997.95	1.0000
02-03	42	2045	127733	1835	633.415	50.97	997.95	1.0000
03-04	42	2045	127733	1835	633.416	50.97	997.95	1.0000
04-05	42	2045	127735	1835	633.422	50.97	997.95	1.0000
05-06	42	2045	127735	1835	633.428	50.97	997.95	1.0000

P T/A: * * * * *
 C T/A: 1772 50137 3131172 45007 525.232 52.43 997.95 23.0557

Reason for Irregularity or Remark : _____

Acknowledged By :

(_____) (_____) (_____)
 (COMP1) (COMP2) (COMP3)

03rpds_previous_day_hourly.txt

Batch report example

No	Date	Batch start	Batch stop	Stream No.	Stream name	Car number plate
1	2022.07.12	2022.07.12 7:49	2022.07.12 7:50	1	Station 1	ABC-123
2	2022.07.12	2022.07.12 7:52	2022.07.12 7:53	1	Station 1	ABC-123
3	2022.07.12	2022.07.12 7:55	2022.07.12 7:57	1	Station 1	ABC-123
4	2022.07.12	2022.07.12 7:59	2022.07.12 8:01	1	Station 1	ABC-123
5	2022.07.12	2022.07.12 8:30	2022.07.12 8:31	1	Station 1	ABC-123

From/To	Base volume (l)	Line volume (l)	Mass (kg)	Base density (kg/m3)	Line density (kg/m3)	Measured density (kg/m3)
Site1 - Site2	23838.4884	23611.1117	17566.7285	736.9058	744.0023	744.0023
Site1 - Site2	22637.2892	21666.6672	16119.7974	712.0905	743.9907	743.9908
Site1 - Site2	43333.3345	43333.3345	32240.0957	744.0018	744.0018	744.0018
Site1 - Site2	27921.9574	28611.1119	22008.3063	788.2075	769.2219	769.222
Site1 - Site2	30046.3389	31388.8897	25192.3941	838.4511	802.5892	802.5893

Temperature (°C)	Absolute pressure (bar)	Gauge pressure (bar)	Conc. %(V/V)	Conc. %(m/m)
7.1691	1	0	0	0
-20	1	0	0	0
15	1	0	0	0
40	1	0	0	0
65	1	0	0	0

Note:

Batch report is a txt file, all the data belonging to one batch are located in one line. Lines are broken in the example above for readability.

Flow meter serial test report report example

```

=====
Flow meter serial test report 2020.06.21 21:39:45
=====

```

	Master Stream	Slave Stream	Deviation Slave vs. Master [%]
Stream_No.:	8	1	
Stream_Name:	ASZK1	ASZK1	
Test_duration [min]:	20		
Test_duration [cycle]:	2400		
UVOL [m3]:	800.1055	800.0695	
UVOL_@Master_PT [m3]:	800.1055	800.0695	-0.004
CVOL [m3]:	44756.2852	44754.2656	-0.005
MASS [kg]:	32390.3184	32388.8555	-0.005
ENERGY [GJ]:	1564.7045	1564.6339	-0.005
P_average [bar]:	50.0000	50.0000	
T_average [°C]:	12.0000	12.0000	
Zline_average [-]:	0.889483	0.889483	
Zbase_average [-]:	0.997806	0.997806	
UVOL_FR_average [m3/h]:	2400.3169	2400.2075	
UVOL_FR_ave_@MastPT [m3/h]:	2400.3169	2400.2075	-0.005
CVOL_FR_average [Sm3/h]:	134268.9062	134262.6250	-0.005
MASS_FR_average [kg/h]:	97170.8125	97166.6016	-0.004
ENERGY_FR_average [GJ/h]:	4694.1089	4693.8984	-0.004
Rel_dens_ave [-]:	0.5906	0.5906	
Base_dens_ave [kg/Sm3]:	0.7237	0.7237	
Line_dens_ave [kg/m3]:	40.4826	40.4826	
L_dens_ave_@MastPT [kg/m3]:	40.4826	40.4826	0.000
ICV_average [MJ/m3]:	34.9606	34.9606	
SCV_average [MJ/m3]:	38.7745	38.7745	
dP_average [mbar]:	0.0000	0.0000	
Average gas composition during the test [mole%]			
N2:	1.0000	1.0000	
CO2:	0.5000	0.5000	
H2S:	0.0000	0.0000	
H2O:	0.0000	0.0000	
Helium:	0.0000	0.0000	
Methane:	95.0000	95.0000	
Ethane:	2.0000	2.0000	
Propane:	1.0000	1.0000	
n-Butane:	0.0000	0.0000	
i-Butane:	0.5000	0.5000	
n-Pentane:	0.0000	0.0000	
i-Pentane:	0.0000	0.0000	
Hexane:	0.0000	0.0000	
Heptane:	0.0000	0.0000	
Octane:	0.0000	0.0000	
Nonane:	0.0000	0.0000	
Decane:	0.0000	0.0000	
Oxygen:	0.0000	0.0000	
CO:	0.0000	0.0000	
H2:	0.0000	0.0000	
Argon:	0.0000	0.0000	
Total:	100.0000	100.0000	

```

=====

```

Annex B. User report editor

Introduction

In UNIFLOW-200 large number of predefined reports exist. The content of those reports cannot be modified. The type and content of the predefined reports described in Annex A.

Beside the predefined reports a tool is provided on the web server of the flow computer to create customized reports, we call them "user defined report". The content and the format of these reports are freely configurable. This Annex D. describes the method how to create and access user defined reports.

User defined reports can only be created via the web server of the flow computer, it cannot be created offline, on the stand-alone PC.

However, the template created in one flow computer can be exported to the PC hard drive and later on can be imported from another flow computer by means of user report editor.

1. Connecting UNIFLOW-200 to PC

To access the web server of the UNIFLOW-200 the Ethernet port of the UNIFLOW-200 shall be connected to the network where the PC is connected.

UNIFLOW-200 can be directly connected to PC via Ethernet cable.



Flow computer – PC Ethernet direct connection

Or it can be connected to PC via switches, routers, LAN/WAN network.



Flow computer – PC Ethernet connection using switch

Note!

UNIFLOW-200 support only fix IP addressing. No DHCP addressing is possible for UNIFLOW-200.

A browser is required to run on the PC to access UNIFLOW-200 web server. We recommend using Firefox for access.

Note, UNIFLOW-200 web server is not optimized for Internet Explorer.

Type the IP address of UNIFLOW-200 into the address bar of the browser and press enter.

A login screen appears requiring enter the password.



UNIFLOW-200 MFC Login

Password :

LOGIN

Enter the password for Engineering level of access to UNIFLOW-200. User report can only be edited at Engineering level. On Operator or Guest level user reports can be reviewed but not modified.

On the main display of UNIFLOW-200 web server click the “User defined report editor” menu item on the lower left corner.

The report editor screen appears.

2. Selecting the report for editing

There are 8 reports available as user defined report. Their name by convention is:

- Defined report11
- Defined report12
- Defined report13

- Defined report14
- Defined report15
- Defined report16
- Defined report17
- Defined report18

Open the dropdown menu in the upper left corner on the editor screen and select the report to be edited.

If the selected report has never been edited before (or has been cleared) then an empty editor pane appears with square grid, having 80 columns and 60 rows.

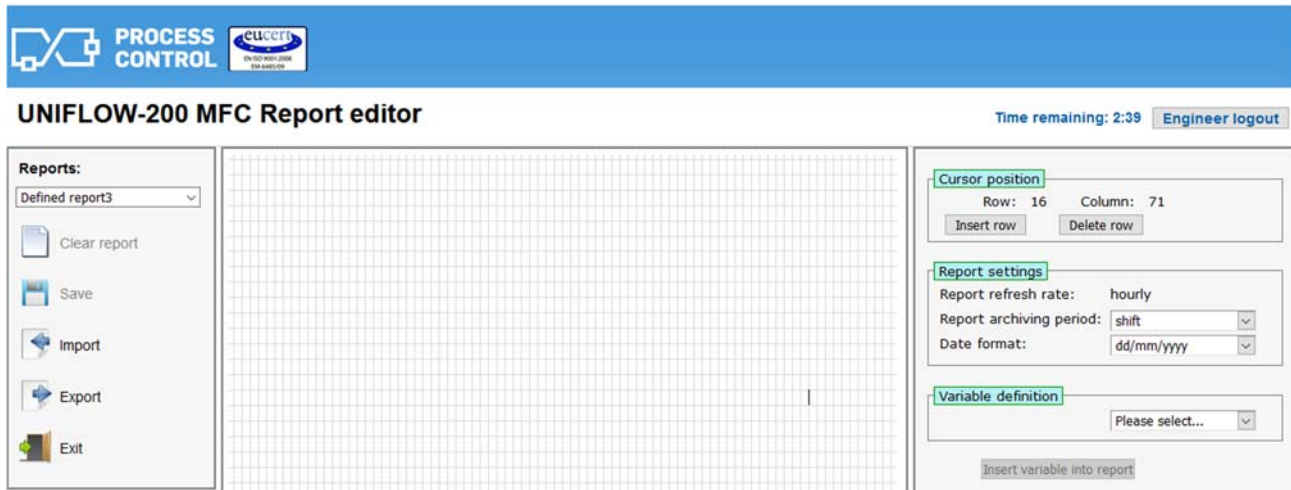

The available command on the left side command bar are as follows:

- Clear report - clears the content of the report being edited
- Save - save the report being edited into the memory of UNIFLOW-200;
- Import - import report template from the PC to UNIFLOW-200. Clicking the command, a file browser window opens. Select the report template file from the PC drive;
- Export - export report template from UNIFLOW-200 to the PC drive. Clicking the command, a file open window appears in the browser. Select the Save file option and in the file browser window select the place where the template file to save.

The default name of the template files is:

- defrep11.zip
- defrep12.zip
- defrep13.zip
- defrep14.zip
- defrep15.zip
- defrep16.zip
- defrep17.zip
- defrep18.zip

- Exit - return to the UNIFLOW-200 web server main display;

Click the square where you want to enter text (any text can be entered) or want to insert report item (the available items for report see later). The cursor will be blinking on the left side of the square. The current position of the cursor can be seen in the upper right corner of the editor pane.

The Insert row and Delete row buttons will insert and delete one row between the report items.

Click the Save button when finished editing the report template and Export it if you want to use the template in other UNIFLOW-200 as well.

3. Report settings

In the report setting area of the editor pane the parameters of the report can be set as follows.

Report settings	
Report refresh rate:	hourly
Report archiving period:	daily <input type="button" value="v"/>
Date format:	dd/mm/yyyy <input type="button" value="v"/>

3.1. Report refresh rate

- hourly

The content of the user defined report will be updated every hour. This parameter is not alterable.

3.2. Report archiving period

Select from the dropdown menu the archiving period of the report. Available options:

- shift
- daily
- multiday
- monthly
- yearly

At the end of the archiving period the reports will be closed and archived. For example, if a monthly report contains hourly data, then at the end of each hour the data for the last hour added to the report.

After the last hour of the month the report is closed and will not be altered any more.

The name of the user defined reports is as follows:

nn_RP_yyyymmdd_hh00_xx.txt

where: nn the serial number of the report from 11 to 18

yyyy year

mm month

dd day

hh hour

xx label indicating the archiving period and also indicating if report is already archived or it is still open (updated every hour)

If xx = xa, then the report is archived, the archiving period is finished.

If the report is still updated then the label indicates the archiving period as follows:

xx = ss shift

xx = dd day

xx = tt multiday

xx = mm month

xx = yy year

If for example the report 11 is archived daily (and the end of day hour is 06:00), then the name

11_RP_20201211_2000_dd.txt denotes a report which contains hourly data from 2020.12.11 07:00 to 2020.12.11 20:00.

At the end of the day (on 2020.12.12. 06:00) the report is archived and the name become:

11_RP_20201212_0600_da.txt

The archived and the open reports are accessible in the UNIArchive program of the U200ToolBox suit (see section 5).

3.3. Date format

The available options are as follows:

- dd/mm/yyyy
- mm/dd/yyyy
- yyyy/mm/dd

The system time on the reports will be displayed according to this setting.

4. Defining report items

In the Variable definition area of the editor pane the data point to be put onto the report can be selected.

The screenshot shows a rectangular box with a title bar labeled 'Variable definition'. Inside the box, there is a dropdown menu with the text 'Please select...' and a downward arrow. Below the dropdown menu, there is a button labeled 'Insert variable into report'.

Put the cursor into the cell on the report area where the report item (data point) to be started. From the dropdown menu select the category of data. Available categories are:

- Machine
- Date
- Table
- M01 stream
- M02 stream
- ...
- M12 stream

The screenshot shows the 'Variable definition' box with the dropdown menu open. The menu lists the following categories: Machine (highlighted in blue), Date, Table, M01 stream, M02 stream, M03 stream, M04 stream, M05 stream, M06 stream, M07 stream, M08 stream, M09 stream, M10 stream, M11 stream, and M12 stream. The 'Insert variable into report' button is visible below the menu.

Depending on the category selected one or more additional data level will appear. Select at each level the desired category while get to the required data point.

For example, if you want to insert the serial number of the flow computer on the report your selection looks like this:

The screenshot shows the 'Variable definition' box with the following configuration: the dropdown menu is set to 'Machine', the second dropdown menu is set to 'Serial no.', the 'Field length:' text is followed by a text input field containing '12', and the third dropdown menu is set to 'Left'. The 'Insert variable into report' button is at the bottom.

You should specify some additional parameter also. In this example the Field length (the number of cells you want to reserve for this data point) and the Alignment (left, center or right).

After the selection is done and all the requested parameters are set, press the Insert variable into report button.
 On the report question marks with turquoise background will occupy the cells reserved for that variable.
 If you locate the cursor over the field the background color turns to red and a pop-up label will show the name of the variable.

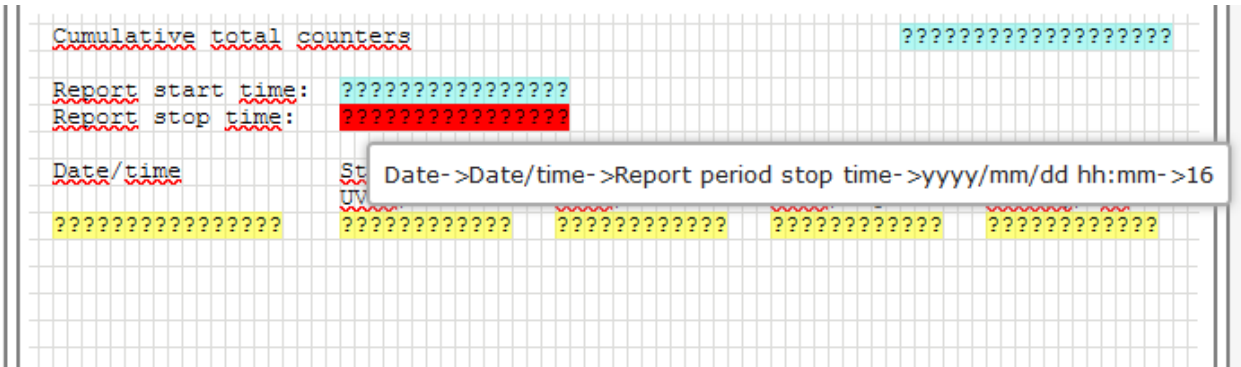

The available items for selection in the different category are listed in the next paragraphs.

4.1. Machine

- User name
The company name is inserted as defined in the General data / Company data parameter section
- User address
The company address is inserted as defined in the General data / Company data parameter section
- Machine name
The machine name is inserted as defined in the General data / Version control parameter section
- Serial no.
The machine serial number is inserted as displayed in the General data / Version control parameter section

4.2. Date

- System time
System date and time is inserted. It will show the date and time when the report is generated/updated
- Date/Time
 - Report period stop time
 - Report period start time

The available date/time formats are depending on the Date type selected in report settings.
 E.g., in case of yyyy/mm/dd date type the available options:

 - yyyy/mm/dd hh:mm
 - yyyy/mm/dd hh:00
 - mm/dd hh:mm
 - mm/dd hh:00
 - yyyy/mm/dd
 - mm/dd
 - hh:00-(hh+1):00

4.3. Table

In this category a multi column table can be defined.
 There are some limitations regarding the size and the format of the table to be taken into account when defining it.

- the maximum number of columns: 10;

- only variable item is allowed in the row, no text is allowed;

The length of the table (the number of rows) is determined by the report archiving period and the period of the variable selected. The possible combinations are shown below.

Report archiving period	Period of the variable	Number of rows in the archived report
Shift	Hourly	8
	Daily	24
Daily	Hourly	3
	Shift	240
	Multiday (assuming 10 days)	30
Monthly (assuming 31 days)	Hourly	10
	Shift	744
	Daily	93
	Multiday	31
Yearly (assuming 365 days)	Hourly	4
	Shift	365
	Multiday	43
	Monthly	12

Put the cursor into the cell in the Table row on the report area where the report item (data point) to be started. Select the required item in the variable definition pane, like this.

Report settings

Report refresh rate: hourly

Report archiving period: monthly

Date format: yyyy/mm/dd

Variable definition

Table

Hourly

Column definition

M01 stream

Cumulative total

UVOL

Total

Integer digits: 12

Decimal digits: 0

Right

Insert variable into report

In this particular example a monthly report is defined and the stream M01 uncorrected volume cumulative total counter is put into the table every hour. So that a table with 744 rows will be archived by the end of month. The width of the column is 12 digits (integer number displayed) and the numbers are aligned right.

After the selection is done and all the requested parameters are set, press the Insert variable into report button.

On the report question marks with yellow background will occupy the cells reserved for that table variable.

If you locate the cursor over the field the background color turns to red and a pop-up label will show the name of the variable.

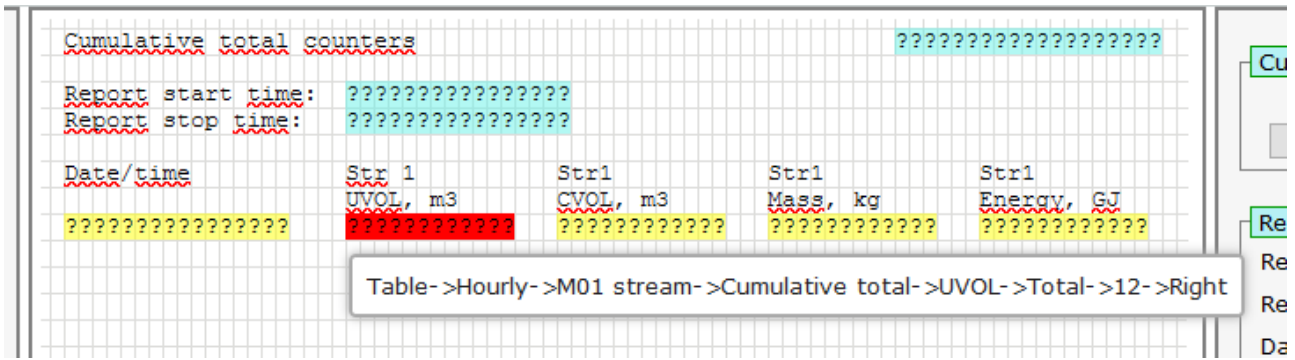

If you click on an existing variable placement (field) the definition of that variable will be displayed on the variable definition pane. You can modify your selection as desired. After pressing the Change column button, the variable selection will be modified accordingly.

The available options at the different level in the column definition are as follows:

- M01 stream
 - Periodic total (periodic totals: for the period the variable defined for, min. and max.: flow rates)
 - CVOL
 - ❖ Total
 - ❖ Fault total
 - ❖ Premium total
 - ❖ Min.
 - ❖ Max.
 - UVOL
 - ❖ same as for CVOL
 - Raw UVOL
 - ❖ same as for CVOL, except Min. and Max.
 - Mass
 - ❖ same as for CVOL
 - Energy
 - ❖ same as for CVOL
 - CO2 mass
 - ❖ same as for CVOL
 - Cumulative total
 - CVOL
 - ❖ Total
 - ❖ Fault total
 - ❖ Premium total
 - UVOL
 - ❖ same as for CVOL
 - Raw UVOL
 - ❖ same as for CVOL
 - Mass
 - ❖ same as for CVOL
 - Energy
 - ❖ same as for CVOL
 - CO2 mass
 - ❖ same as for CVOL
 - Process data (averages for the period the variable defined for)
 - Temperature
 - Absolute pressure
 - Differential pressure
 - Line density
 - Compression factor
 - Carbon number
 - Inferior calorific value
 - Superior calorific value
 - Relative density
 - Normal density
 - Gas component

- Nitrogen
 - ❖ Min.
 - ❖ Max.
 - ❖ Average
- Carbon-dioxide
- Hydrogen-sulfide
- Water
- Helium
- Methane
- Ethane
- Propane
- n-Butane
- i-Butane
- n-Pentane
- i-Pentane
- n-Hexane
- n-Heptane
- n-Octane
- n-Nonane
- n-Decane
- Oxygen
- Carbon-monoxide
- Hydrogen
- Argon
- Ammonia
- Benzene
 - ❖ for all components same as for Nitrogen
- Flow time
 - Total flow time
 - Fault flow time

Note, the flow time displayed in hours with decimal part of hours (not in the format hour and minute).
- M02 stream
 - same as for M01
- ...
- M12 stream
 - same as for M01
- Date/time

Data/time when the current row of the table is updated.
The available date/time formats are depending on the Date type selected in report settings. E.g., in case of yyyy/mm/dd date type the available options:

 - yyyy/mm/dd hh:mm
 - yyyy/mm/dd hh:00
 - mm/dd hh:mm
 - mm/dd hh:00
 - yyyy/mm/dd
 - mm/dd
 - hh:00-(hh+1):00

4.4. Stream data (M01...M12)

In the stream data category individual data (cumulative totals, interval totals, averages) for the selected stream can be inserted into the report.

The category of data available at stream level are as follows:

- stream name
- actual period
- previous period

4.4.1. Stream name

Insert the name of the stream as entered in the Stream definition menu.

4.4.2. Actual/Previous period data

The term “period” in this context means the Report archiving period as set in the Report settings section. In the example below the period is “daily”.

Report settings	
Report refresh rate:	hourly
Report archiving period:	daily
Date format:	dd/mm/yyyy

The Current period means the period being in progress.
The Previous period means the last period which has been finished.

The data point (variable) itself also can have period. The period of the data point cannot be shorter than the report archiving period. E.g., into the daily report data point with daily, multiday or monthly period can be inserted. The limits are shown in the table below.

Report archiving period	Period of the variable
Shift	Shift
	Daily
	Multiday
Daily	Monthly
	Daily
	Multiday
Multiday	Monthly
	Multiday
	Monthly
Monthly	Monthly
	Yearly
Yearly	no periodic data available

Data for the current period will be updated in the report in every hour and their value may change.
Value of the data for the previous period will never be changed on the report as it is related to the period already finished.

The available options at the different level in the stream data definition are as follows (they are identical to the options available for table items, see 4.3):

- Actual period
 - Periodic total (periodic totals: for the period the variable defined for, min. and max.: flow rates)
 - CVOL
 - ❖ Total
 - ❖ Fault total
 - ❖ Premium total
 - ❖ Min.
 - ❖ Max.
 - UVOL
 - ❖ same as for CVOL
 - Raw UVOL
 - ❖ same as for CVOL, except Min. and Max.
 - Mass
 - ❖ same as for CVOL
 - Energy
 - ❖ same as for CVOL
 - CO2 mass
 - ❖ same as for CVOL
 - Cumulative total
 - CVOL
 - ❖ Total
 - ❖ Fault total
 - ❖ Premium total

- UVOL
 - ❖ same as for CVOL
- Raw UVOL
 - ❖ same as for CVOL
- Mass
 - ❖ same as for CVOL
- Energy
 - ❖ same as for CVOL
- CO2 mass
 - ❖ same as for CVOL
- LF pulse counter
 - ❖ Total
- Process data (averages for the period the variable defined for)
 - Temperature
 - Absolute pressure
 - Differential pressure
 - Line density
 - Compression factor
 - Carbon number
 - Inferior calorific value
 - Superior calorific value
 - Relative density
 - Normal density
- Gas component
 - Nitrogen
 - ❖ Min.
 - ❖ Max.
 - ❖ Average
 - Carbon-dioxide
 - Hydrogen-sulfide
 - Water
 - Helium
 - Methane
 - Ethane
 - Propane
 - n-Butane
 - i-Butane
 - n-Pentane
 - i-Pentane
 - n-Hexane
 - n-Heptane
 - n-Octane
 - n-Nonane
 - n-Decane
 - Oxygen
 - Carbon-monoxide
 - Hydrogen
 - Argon
 - Ammonia
 - Benzene
 - ❖ for all components same as for Nitrogen
- Flow time
 - Total flow time
 - Fault flow time

Note, the flow time displayed in hours with decimal part of hours (not in the format hour and minute).
- Previous period
 - same as for Current period

Unit of measurement is not appended to the individual stream data. It should be entered into the report as text.

5. Accessing user defined reports

User defined reports can be accessed in different ways described below.

5.1. Saving reports to PC by UNIArchive

The U200ToolBox suit includes program for reading archive files from UNIFLOW-200.

Launch the UNIArchive from the start menu of the U200ToolBox.



Select the name and/or the IP address of UNIFLOW-200 to be read and press Upload from flow computer.

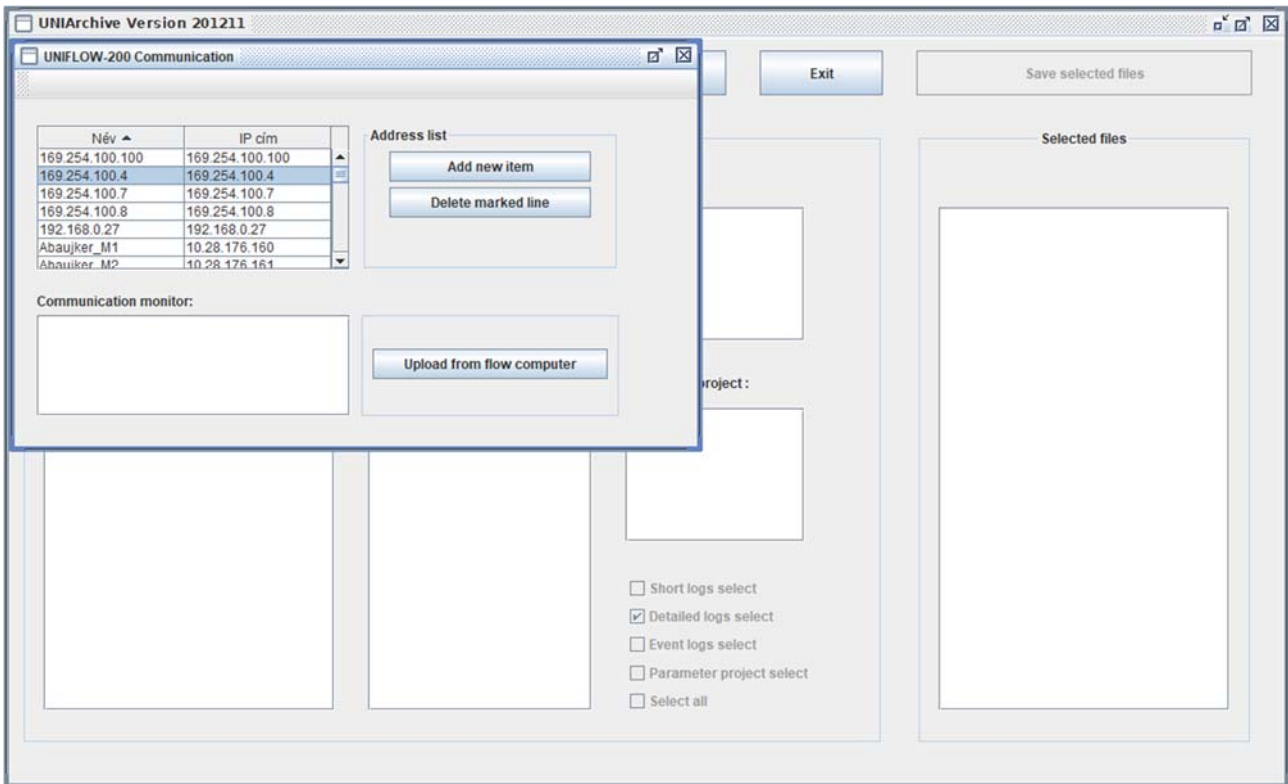

After successful upload the list of archive reports a selection pane appears.

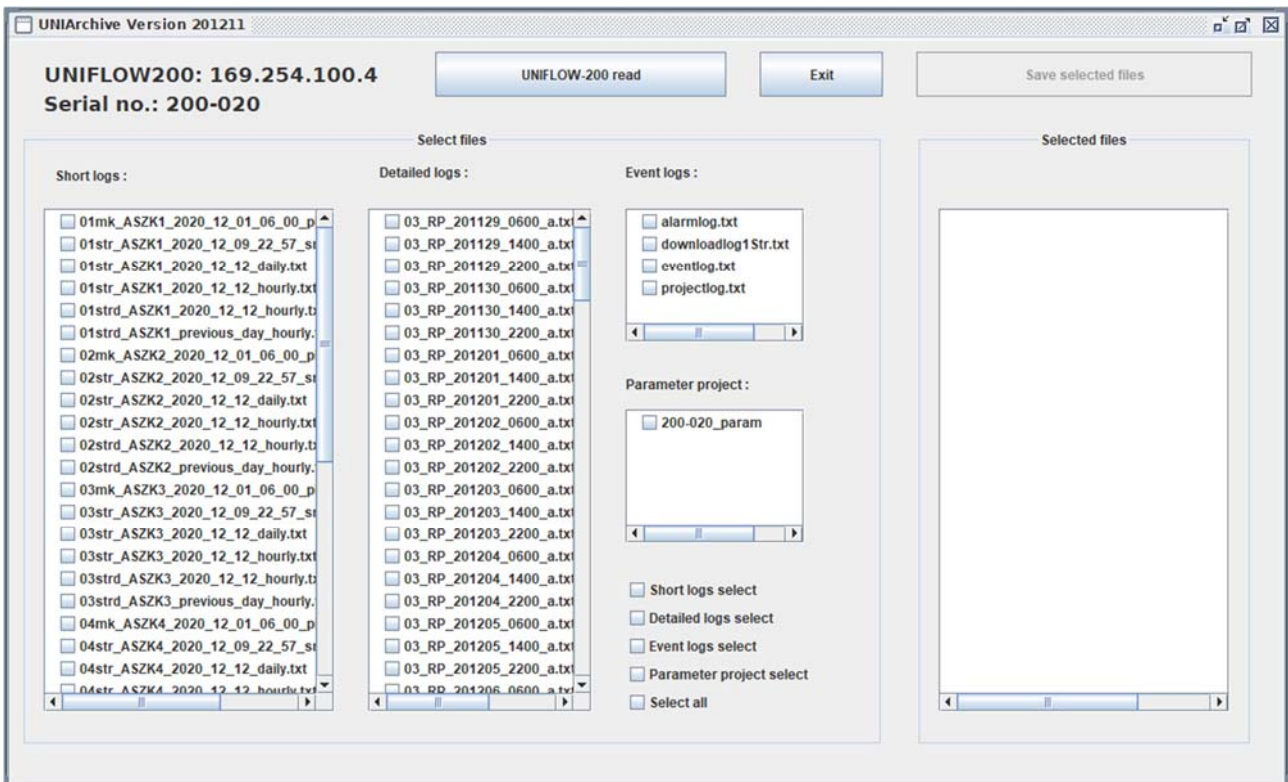

The file names of the user defined reports are listed in the "Detailed logs" column.

Click the check box in front of the file names one-by-one, or, click the "Detailed logs select" check box if you want to save all detailed files.

The name of the selected files appears in the "Selected files" column.

Click the Save selected files button to save files to drive of the PC.

5.2. Saving reports to flash drive

Insert flash drive into the USB port of UNIFLOW-200. Wait until message with red background appears on the display, suggesting saving the data before upgrading firmware or parameter project.

Leave the selection to “yes” and press OK button.

The Archive data transfer page appears.

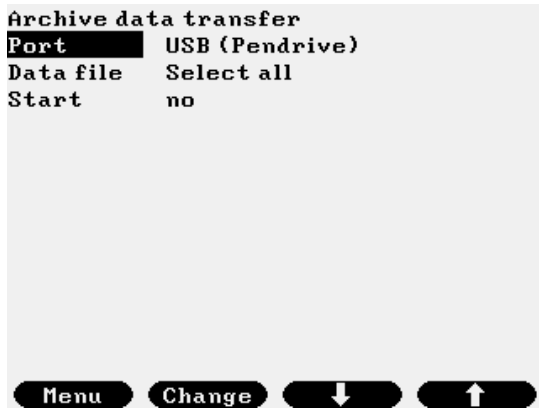

Leave the port selection to “USB (Pendrive)”.

Select the “Data file” field and by pressing Change button select the file you want to transfer. Or leave it to “Select all”, which means all the archive files will be transferred to flash drive.

Select the “Start” field, change it to yes and press OK.

Message Transfer in progress... indicates that the files are being copied to flash drive.

When copying finished a message appears saying you can remove the flash drive.

UNIFLOW-200 will create a directory on the flash drive which name is the serial number of the UNIFLOW-200, e.g., 200-020.

The archive files are placed into this directory.

5.3. Printing reports to serial printer

Navigating on the display of UNIFLOW-200 go to the page Flow / Data transfer / Archive data transfer (see above in 5.2.).

Change the port to the Com port where the serial printer is connected to.

Select the data file to be printed, change Start to yes and press OK.

The report will be sent to the printer.

5.4. Printing reports to serial printer when the report generated

If serial printer is permanently attached to UNIFLOW-200 then it is possible to set up printing the user defined report when it is generated.

In the Com port setup, if the function of the Com port is serial printer, then the automatic printing can be enabled.

Select the period of printing “daily” (if only daily reports to print) or “daily & hourly” (if both daily and hourly reports to print).

Set the selection box to “yes” for the user defined reports to be printed automatically.

In the example below user defined report 3 and 4 selected for printing.

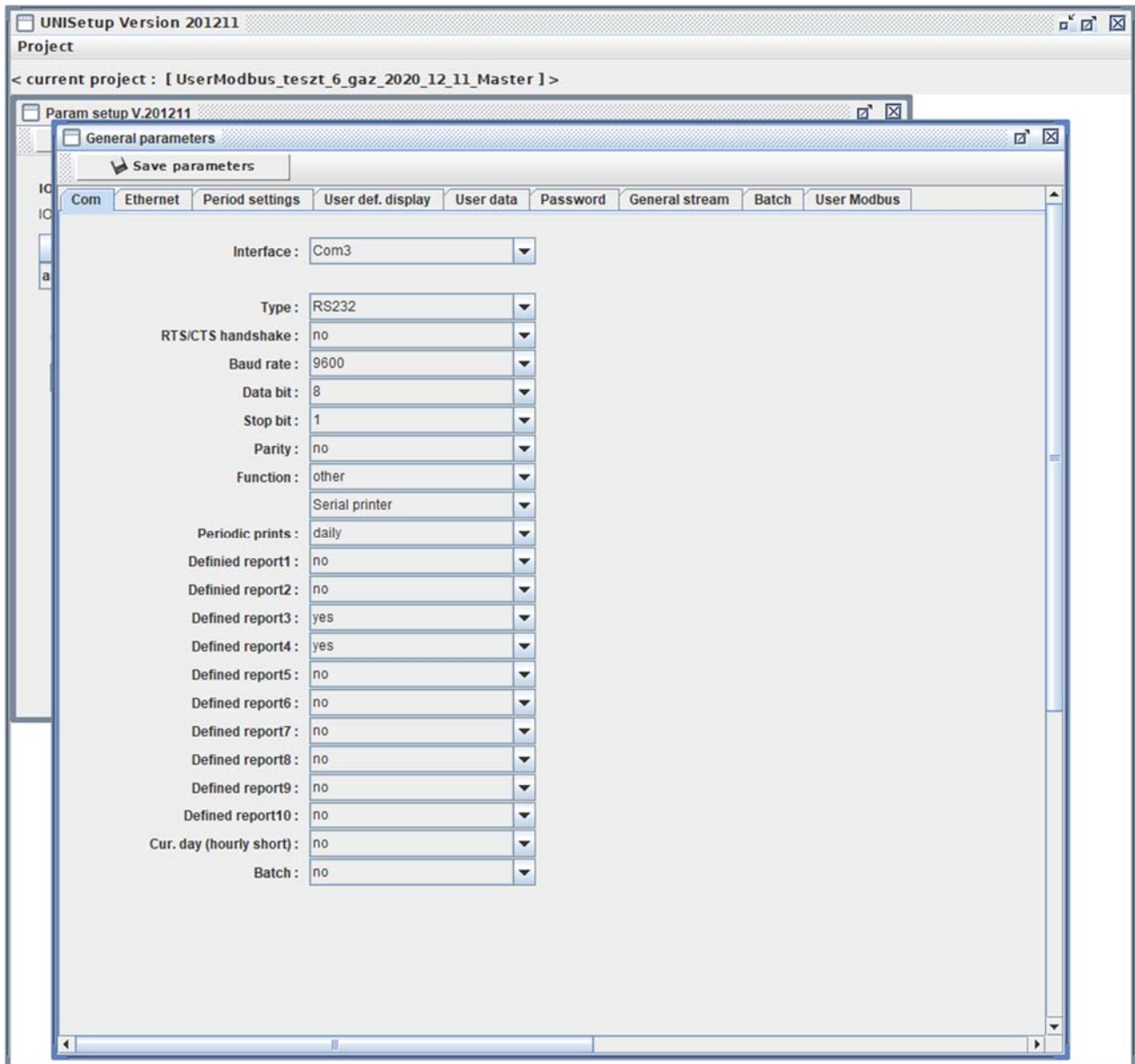

6. Sample user defined report

Below is a sample of the user defined report.

The report archiving period is "monthly".

On the subsequent pages you can see sections from the report as generated during the month.

* on the placement indicates that no data is available for that period. Such mark denotes all the future date.

If it appears for the date in the past, then most probably the flow computer was out of operation at that moment of time.

on the placement indicates that the number is too big for the format (integer digits and decimal digits) specified for that data point.

```

Cumulative total counters
Report start:
Report stop:

Counters by hours
Date/time Str1 CVOL Str2 CVOL Str3 CVOL Str4 CVOL

Counters by days
Date/time Str1 CVOL Str2 CVOL Str3 CVOL Str4 CVOL

Daily CVOL
Date/time Str1 CVOL Str2 CVOL Str3 CVOL Str4 CVOL

Stream 1 monthly data
Monthly quantities UVOL, m3 CVOL, m3 Mass. kg Energy, GJ
Current month:
Previous month:

Current month, average:
minimum:
maximum:
    
```

Cursor position
 Row: 1 Column: 1
 Insert row Delete row

Report settings
 Report refresh rate: hourly
 Report archiving period: monthly
 Date format: yyyy/mm/dd

Variable definition
 Please select...

Insert variable into report

Printout of the sample report

Cumulative total counters

2020.12.14 09:00:10

Report start: 2020/12/01 06:00

Report stop: 2021/01/01 06:00

Counters by hours

Date/time	Str1 CVOL	Str2 CVOL	Str3 CVOL	Str4 CVOL
	1.Stream CVOL counter m3	2.Stream CVOL counter m3	3.Stream CVOL counter m3	4.Stream CVOL counter m3
2020/12/01 07:00	381544	681416	403460	325142
2020/12/01 08:00	381544	681416	403460	331119
2020/12/01 09:00	381544	681416	403460	337097
2020/12/01 10:00	381544	681416	403460	343075
2020/12/01 11:00	381544	681416	403460	349053
2020/12/01 12:00	381544	681416	403460	355028
2020/12/01 13:00	381544	681416	403460	361006
2020/12/01 14:00	381544	681416	403460	366984
2020/12/01 15:00	381544	681416	403460	372962
2020/12/01 16:00	381544	681416	403460	378940
2020/12/01 17:00	381544	681416	403460	384918
2020/12/01 18:00	381544	681416	403460	390896
2020/12/01 19:00	381544	681416	403460	396874
2020/12/01 20:00	*	*	*	*
2020/12/01 21:00	*	*	*	*
2020/12/01 22:00	*	*	*	*
2020/12/01 23:00	*	*	*	*
2020/12/02 00:00	*	*	*	*
2020/12/02 01:00	*	*	*	*
2020/12/02 02:00	*	*	*	*
2020/12/02 03:00	*	*	*	*
2020/12/02 04:00	*	*	*	*
2020/12/02 05:00	*	*	*	*
2020/12/02 06:00	*	*	*	*
2020/12/02 07:00	*	*	*	*
...				
...				
...				
2020/12/05 07:00	0	1229006	951846	854498
2020/12/05 08:00	0	1229006	951846	862800
2020/12/05 09:00	0	1229006	951846	871102
2020/12/05 10:00	0	1229006	951846	879405
2020/12/05 11:00	0	1229006	951846	887708
2020/12/05 12:00	0	1229006	951846	896011
2020/12/05 13:00	0	1229006	951846	904313
2020/12/05 14:00	0	1229006	951846	912616
2020/12/05 15:00	0	1229006	951846	920919
2020/12/05 16:00	0	1229006	951846	929222
2020/12/05 17:00	0	1229006	951846	937526
2020/12/05 18:00	0	1229006	951846	945829
2020/12/05 19:00	0	1229006	951846	954132
2020/12/05 20:00	0	1229006	951846	962435
2020/12/05 21:00	0	1229006	951846	970738
2020/12/05 22:00	0	1229006	951846	979041
2020/12/05 23:00	0	1229006	951846	987344
2020/12/06 00:00	0	1229006	951846	995647

2020/12/06 01:00	0	1229006	951846	1003950
2020/12/06 02:00	0	1229006	951846	1012252
2020/12/06 03:00	0	1229006	951846	1020555
2020/12/06 04:00	0	1229006	951846	1028857
2020/12/06 05:00	0	1229006	951846	1037160
2020/12/06 06:00	0	1229006	951846	1045463
...				
...				
...				
2020/12/31 07:00	*	*	*	*
2020/12/31 08:00	*	*	*	*
2020/12/31 09:00	*	*	*	*
2020/12/31 10:00	*	*	*	*
2020/12/31 11:00	*	*	*	*
2020/12/31 12:00	*	*	*	*
2020/12/31 13:00	*	*	*	*
2020/12/31 14:00	*	*	*	*
2020/12/31 15:00	*	*	*	*
2020/12/31 16:00	*	*	*	*
2020/12/31 17:00	*	*	*	*
2020/12/31 18:00	*	*	*	*
2020/12/31 19:00	*	*	*	*
2020/12/31 20:00	*	*	*	*
2020/12/31 21:00	*	*	*	*
2020/12/31 22:00	*	*	*	*
2020/12/31 23:00	*	*	*	*
2021/01/01 00:00	*	*	*	*
2021/01/01 01:00	*	*	*	*
2021/01/01 02:00	*	*	*	*
2021/01/01 03:00	*	*	*	*
2021/01/01 04:00	*	*	*	*
2021/01/01 05:00	*	*	*	*
2021/01/01 06:00	*	*	*	*

Counters by days
Date/time

Date/time	Str1 CVOL	Str2 CVOL	Str3 CVOL	Str4 CVOL
	1.Stream CVOL counter m3	2.Stream CVOL counter m3	3.Stream CVOL counter m3	4.Stream CVOL counter m3
-				
2020/12/02 06:00	*	*	*	*
2020/12/03 06:00	480216	935236	657615	491680
2020/12/04 06:00	562735	1229006	951846	646937
2020/12/05 06:00	0	1229006	951846	846195
2020/12/06 06:00	0	1229006	951846	1045463
2020/12/07 06:00	0	1229006	951846	1170508
2020/12/08 06:00	0	1229006	951846	1170508
2020/12/09 06:00	0	1229006	951846	1170508
2020/12/10 06:00	0	1229006	951846	1333130
2020/12/11 06:00	0	1229006	951846	1532394
2020/12/12 06:00	0	1229005	951845	1731459
2020/12/13 06:00	709566	2102849	1826804	1930267
2020/12/14 06:00	895833	2102849	1826804	2129536
2020/12/15 06:00	*	*	*	*
2020/12/16 06:00	*	*	*	*
2020/12/17 06:00	*	*	*	*
2020/12/18 06:00	*	*	*	*
2020/12/19 06:00	*	*	*	*
2020/12/20 06:00	*	*	*	*

2020/12/21 06:00	*	*	*	*
2020/12/22 06:00	*	*	*	*
2020/12/23 06:00	*	*	*	*
2020/12/24 06:00	*	*	*	*
2020/12/25 06:00	*	*	*	*
2020/12/26 06:00	*	*	*	*
2020/12/27 06:00	*	*	*	*
2020/12/28 06:00	*	*	*	*
2020/12/29 06:00	*	*	*	*
2020/12/30 06:00	*	*	*	*
2020/12/31 06:00	*	*	*	*
2021/01/01 06:00	*	*	*	*

Daily CVOL

Date/time	Str1 CVOL 1.Stream CVOL	Str2 CVOL 2.Stream CVOL	Str3 CVOL 3.Stream CVOL	Str4 CVOL 4.Stream CVOL
-	-	-	-	-
-	m3	m3	m3	m3
2020/12/02 06:00	*	*	*	*
2020/12/03 06:00	98671	253819	254155	172517
2020/12/04 06:00	82519	293770	294230	155256
2020/12/05 06:00	0	0	0	199259
2020/12/06 06:00	0	0	0	199267
2020/12/07 06:00	0	0	0	125045
2020/12/08 06:00	0	0	0	0
2020/12/09 06:00	0	0	0	0
2020/12/10 06:00	0	0	0	162623
2020/12/11 06:00	0	0	0	199264
2020/12/12 06:00	0	0	0	199065
2020/12/13 06:00	146832	873844	874958	198807
2020/12/14 06:00	186266	0	0	199270
2020/12/15 06:00	*	*	*	*
2020/12/16 06:00	*	*	*	*
2020/12/17 06:00	*	*	*	*
2020/12/18 06:00	*	*	*	*
2020/12/19 06:00	*	*	*	*
2020/12/20 06:00	*	*	*	*
2020/12/21 06:00	*	*	*	*
2020/12/22 06:00	*	*	*	*
2020/12/23 06:00	*	*	*	*
2020/12/24 06:00	*	*	*	*
2020/12/25 06:00	*	*	*	*
2020/12/26 06:00	*	*	*	*
2020/12/27 06:00	*	*	*	*
2020/12/28 06:00	*	*	*	*
2020/12/29 06:00	*	*	*	*
2020/12/30 06:00	*	*	*	*
2020/12/31 06:00	*	*	*	*
2021/01/01 06:00	*	*	*	*

Stream 1 monthly data

Monthly quantities	UVOL,m3	CVOL,m3	Mass. kg	Energy,GJ
Current month:	12795	537572	400980	17118
Previous month:	5854	381544	265863	13044
	Pressure barA	Temperature °C	Line density kg/m3	

Current month, average:	45.65	39.78	32.22
minimum:	1.00	-10.00	0.00
maximum:	100.00	500.00	110.11

Annex C User Modbus editor

Introduction

UNIFLOW-200 has two predefined Modbus register assignments (register sets):

- Standard Modbus register map (see section 10.5 in the Manual)
- Daniel Modbus register map (see section 10.6 in the Manual)

To increase the flexibility of the Modbus communication a third, user defined register map is implemented, it is called User Modbus tables.

The User Modbus table is fully configurable. Data point assigned to registers and data format are set during the configuration, in the User Modbus editor.

User Modbus table can be edited in the ToolBox software suit in UNISetup.

No editing via UNIFLOW-200 display and keypad is possible.

The data format in the User Modbus table is according to the standard Modbus specification, see section 10.4.3 in the Manual. No Daniel data format is supported.

1. Adding User Modbus table to parameter project

If parameter project is created as new project with ToolBox version 210105 or later then the default User Modbus table is automatically created.

The default User Modbus table cannot be edited. It can be opened and saved under different name. The saved copy of the default table can be modified as desired.

New empty User Modbus table can also be created and filled as desired.

Up to 16 User Modbus table can be created. Any of them can be assigned to Ethernet port or to any serial port. The assignment can be modified even during the operation of the flow computer.

If parameter project was created with earlier than 210105 version of the ToolBox then the procedure is as follows:

- open the parameter project;
- go to the menu item Project / Project conversion

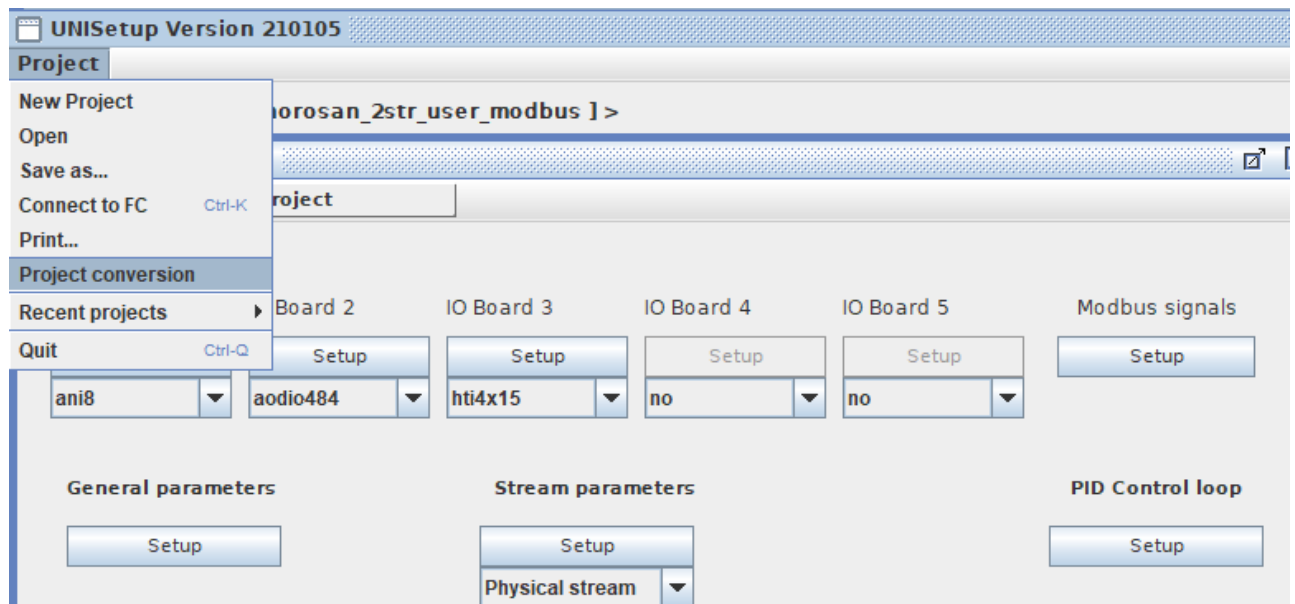

- follow the instruction and save the converted project.

2. Editing User Modbus table

When the project is open in UNISetup click the General parameters Setup button.

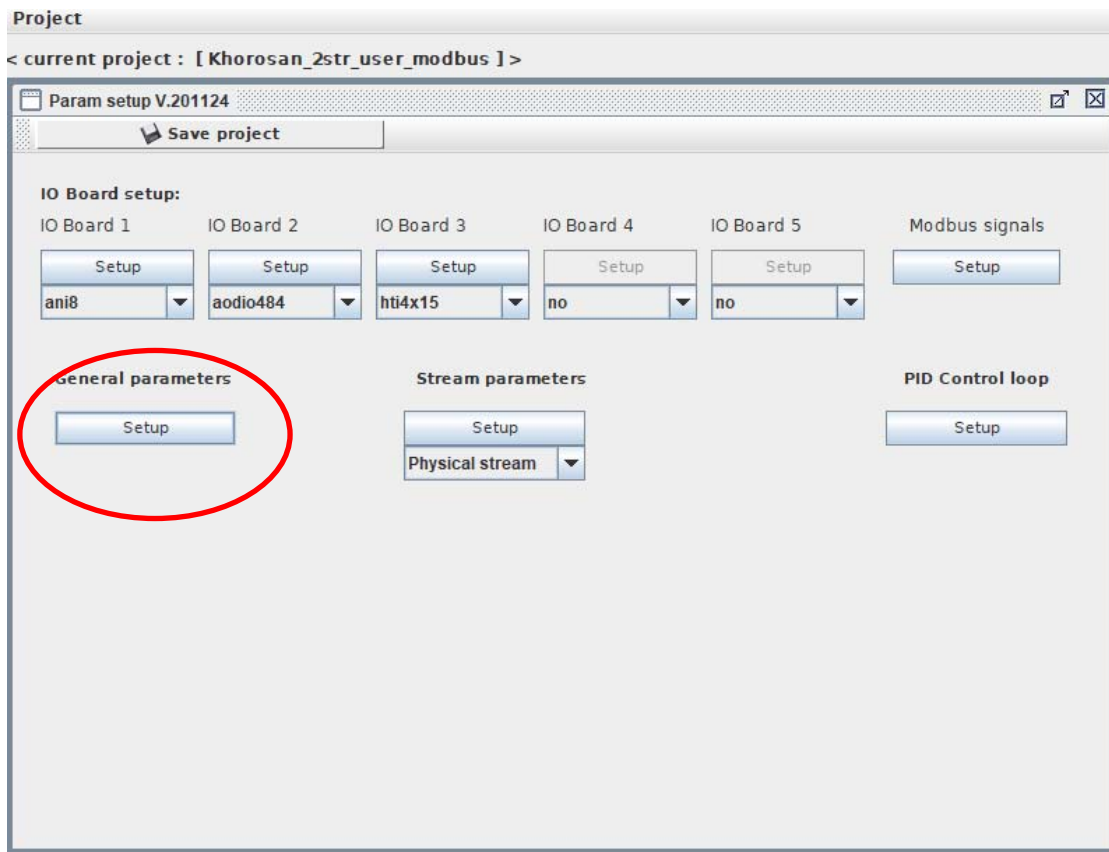

In the window opened click the User Modbus tab, then click the table icon on the left.

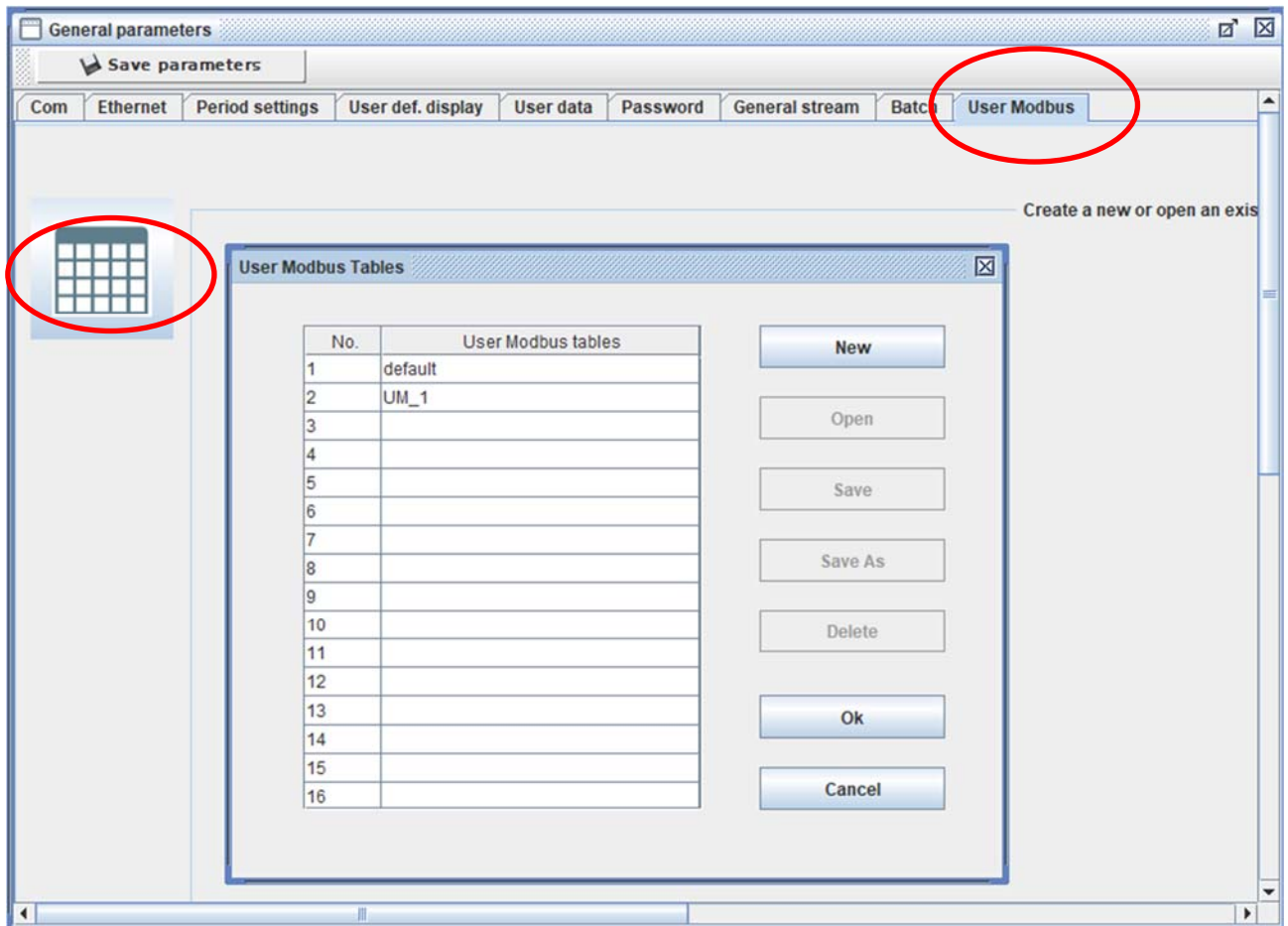

List of the existing User Modbus tables will appear. In case of new or converted project only the default table will be shown.

The buttons on the table list window allow:

New – create new table

Open – open existing table

Save – save table

Save As – save table under different name

Delete – delete table

OK – confirms the operation

Cancel – cancels the operation

After entering name for a new table and clicking OK an empty table appears and only the Insert button will be active.

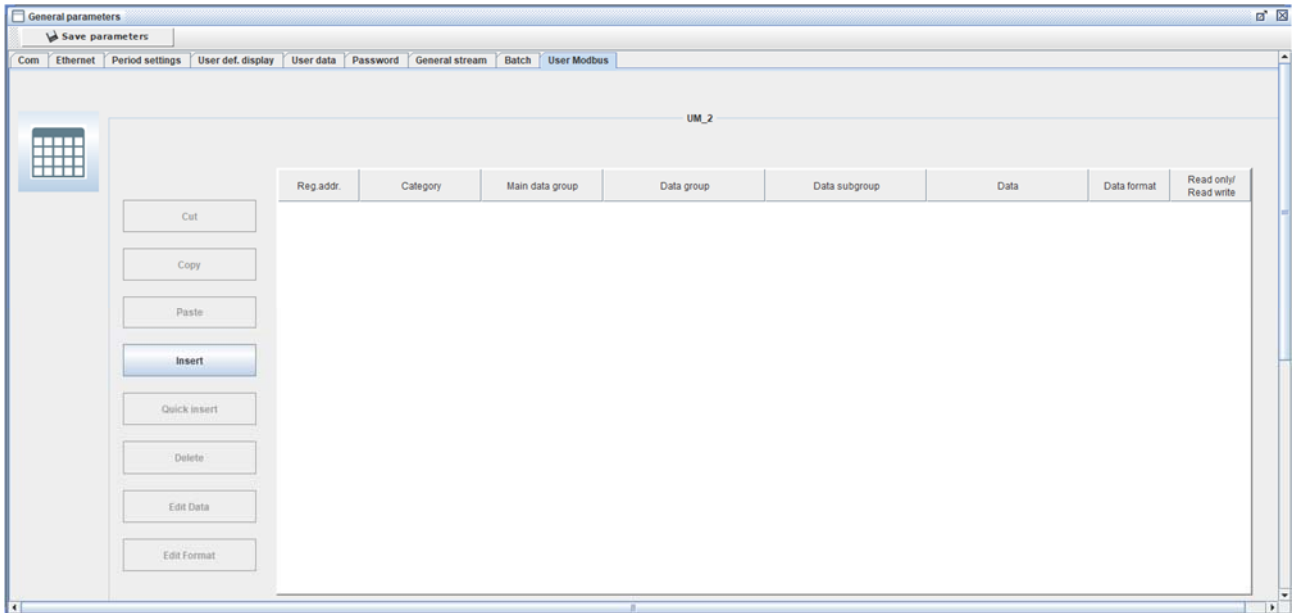

Clicking Insert button a data selection window opens.

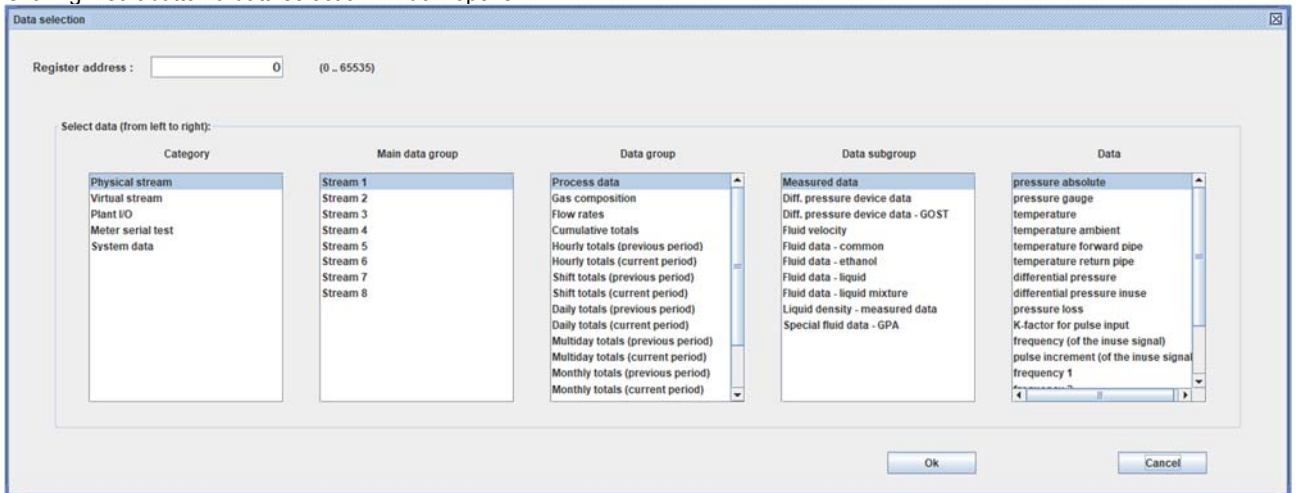

Enter the register address where you want to put data point.

Then, from left to right select the data category, main group, group, subgroup and finally the data point.

After the selection is made click OK.

The data point will be seen in the register list.

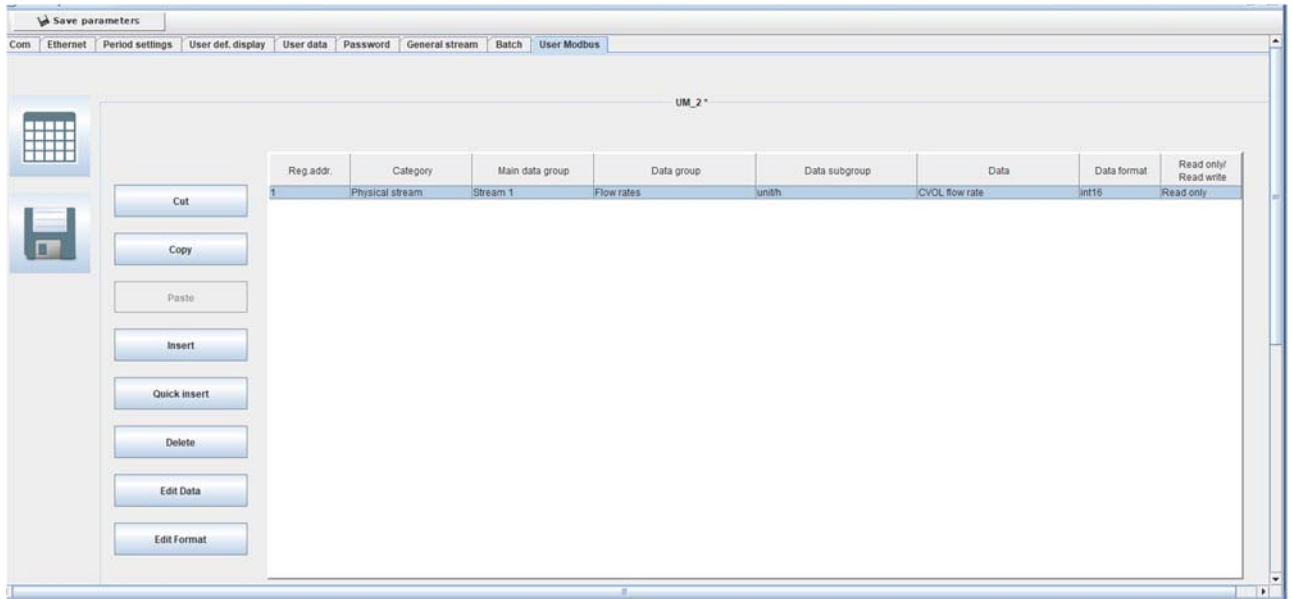

In the data selection window practically any data point which exists in the Uniflow-200 can be assigned to any Modbus register.

The data points include flow rates, cumulative totals, periodic totals, averages, gas composition, process data, alarms, ultrasonic meter diagnostic information, I/O boards channel measured data, etc.

If you modify the table comparing to the status when it was opened or created, a Save icon (a floppy disc) will appear below the table icon. Click the icon to save the changes.

Selecting data points

Click to any field of the data point to select it.

Holding shift key and clicking a new data point will select range of data points.

The Cut, Copy, Delete and Edit format buttons will work with single data point and with range of data points as well.

The function of the buttons on the register list window is as follows:

Cut – removes data point for subsequent insertion into different register;

Copy – copies data point for subsequent insertion into different register;

Paste – inserts data point(s) after Cut or Copy command. Will request enter the starting register to paste;

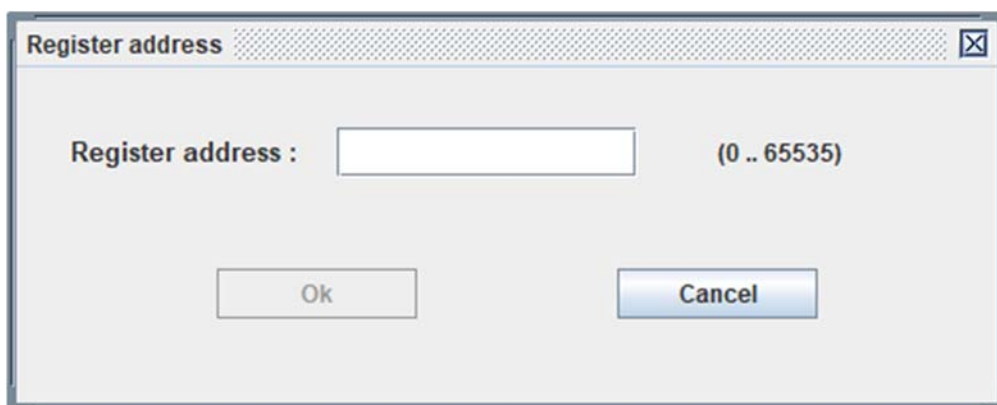

Insert – insert data point into the selected register;

Quick insert – insert the next data point from the data subgroup into the next register;

Delete – deletes data point (or range);

Edit Data – allows modify the data point;

Edit Format – allows set the data format. The available data formats are:

- int16 (16 bit unsigned integer)
- int32 (32 bit signed integer)
- float32 (single precision floating point number)

- float64 (double precision floating point number)

Single data point or range of data points data format can be edited as shown below.

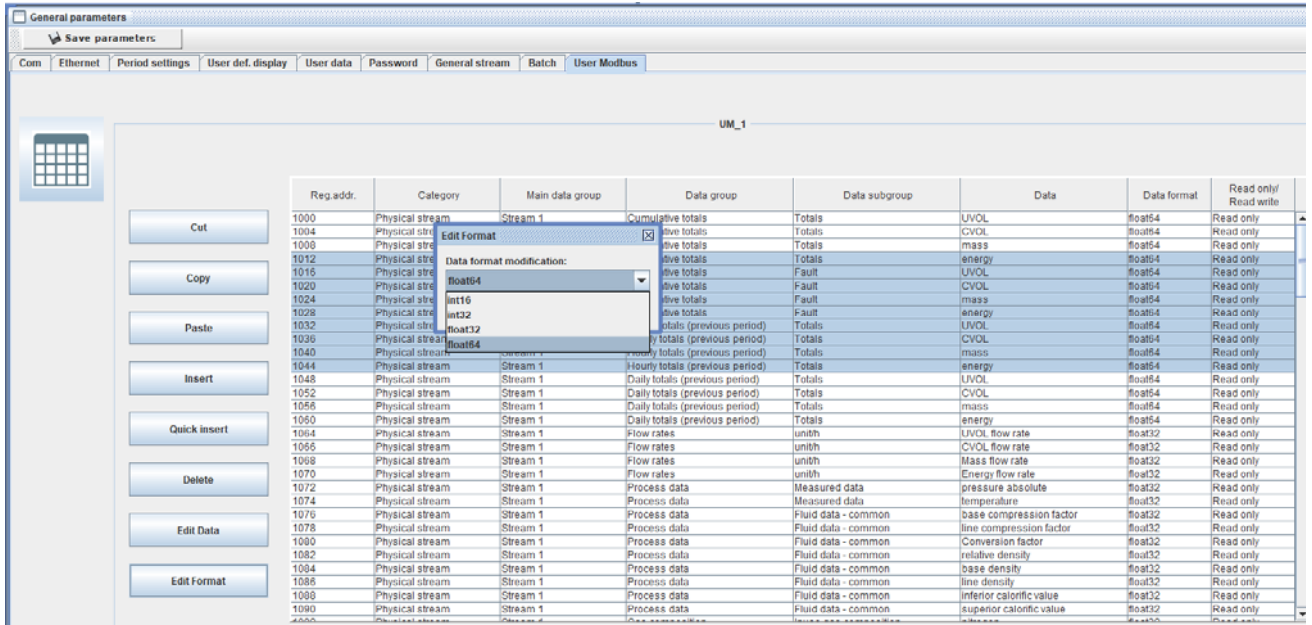

Some limitations to be taken into account.

In the Gas composition data group, there are 3 subgroups:

- In-use gas composition
- Downloaded gas composition
- Gas composition read from gas chromatograph

From the latter two subgroups only one can be selected for any stream, not both. The gas composition can come from the supervisory system (downloaded) or can be read from gas chromatograph.

In the Meter serial test, there are two data groups:

- Master
- Slave

Only one of them can be selected in any unit, as far as in the serial test on flow computer must be the Master and the other(s) must be the Slave.

In the Master unit the "Slave data" (data read from Slave unit) can also be assigned to Modbus registers.

3. Assigning User Modbus table to communication ports

Serial port

In the General parameters setup window select the Com tab and select the desired serial port.

Set the function to User Modbus and select the User Table to assign to that serial port (UM_1 in the sample below).

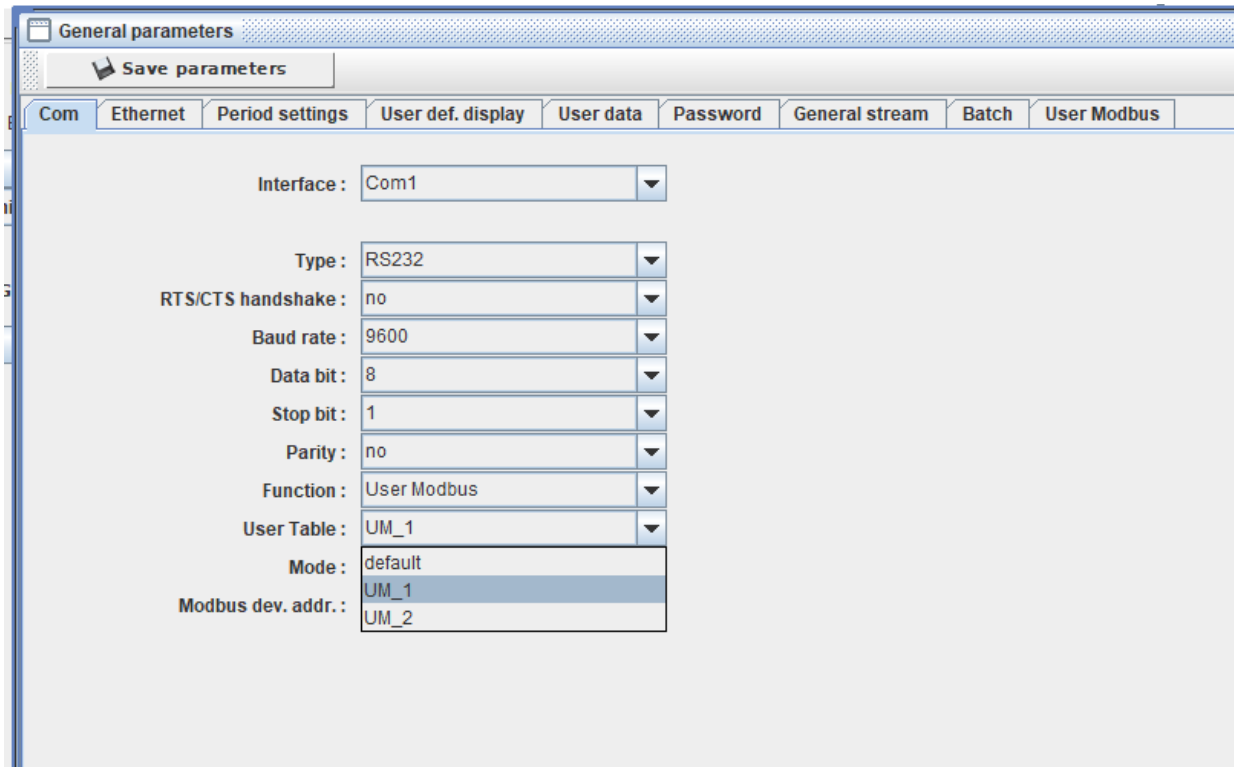

Ethernet port

In the General parameters setup window select the Ethernet tab.

Set the register assignment to User Modbus and select the User Modbus table to assign to the Ethernet port (UM_1 in the sample below).

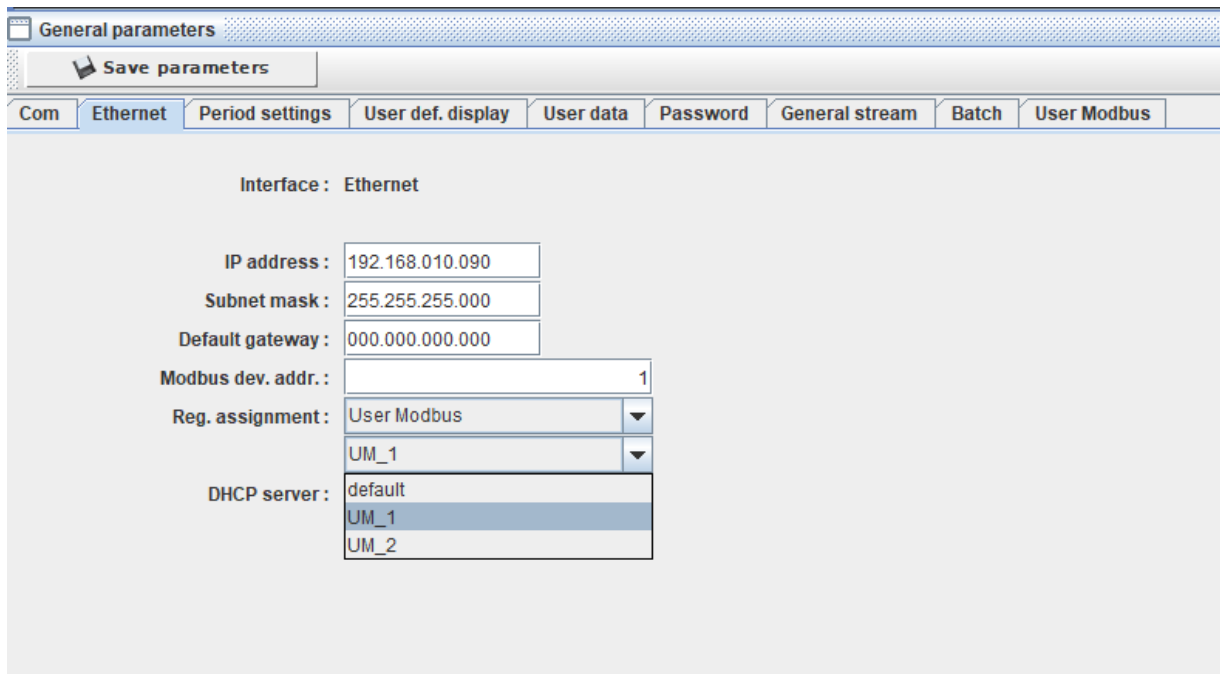

4. Checking User Modbus register content on the display

Go to the Main menu / Flow / Modbus regs menu item.

Go to the parameters section. Set the register mode to User Modbus.

The name of an active User Modbus table appears. If different User Modbus tables are assigned to different ports then you can select between the active User Modbus tables.

Set the starting register and go to Data section.

Content of the registers will be displayed in hexadecimal format and in the format set for that register (int16, int32, float32 or float64).

Main menu	Streams	Modbus registers	
	Plant I/O	Register mode	User Modbus
Flow	Archive data		ETH - UM_1
	Modbus regs	Starting register	110
	Data transfer	Type of register	read only
	Extra summ.disp	address hexadec.	float32
	Batches	110	0000
	Meter serial test	111	4224
	PID	112	0000
		113	4220
		114	9B66
		115	4465
		116	23AA
		117	4469
		Param.	

Annex D. Application notes for HTI4x15 I/O board

The HTI4x15 I/O board is designed to communicate with transmitters with HART protocol. One board is capable to serve 4 HART loops with maximum 15 process variable (PV) on each loop. The maximum number of input channels on one board is limited to 32.

Multidrop mode

In multidrop mode one loop can accommodate maximum 15 transmitters and maximum 15 PVs can be read. If more than one PV is read from one transmitter then the maximum number of transmitter in one loop is decreased accordingly.

The parameters of the HART channels are setup in the I/O signal setup menu. The process variables from the transmitters are assigned to the channels of the IO board. The assignment shall be started from channel 1 and shall be continuous.

Parameters to be defined for each channel are as follows:

- serial number of HART loop (1 to 4);
- polling address of the transmitter (1 to 15)
- serial number of the process variable (1 to 4)

The low scale and high scale values for the channel must be set equal to the low scale and high scale value set in the transmitter.

Transmitter mode

In transmitter mode only one transmitter is connected on one loop. In this mode the transmitter current signal can be connected to some external device (e.g. PLC or DCS) analog input board while UNIFLOW-200 will read the process variable from the transmitter on HART protocol.

The polling address in transmitter mode must be set to 0.

Transmitter settings

The parameters of the transmitter shall be setup before it is connected to UNIFLOW-200. The hand held communicator can be used to setup the transmitter.

Precautions to be observed in transmitter setup:

- the low scale and high scale values in the transmitter must be equal with the ones set in the UNIFLOW-200;
- the polling address must be from 0 to 15;
- transmitters connected to one loop must have different polling addresses;
- no transmitter can be set to burst mode.

Wiring and cabling

Transmitters shall be wired as shown in Annex B.

The load resistance in the HART loop (if there is no other consideration) shall be $R_t = 250$ ohms. HART recommend resistance from 230 to 1100 ohms.

Rules to be followed selecting the loop resistance:

- the minimum operational voltage should be provided for all the transmitters connected in one loop. This minimum voltage is from 6 to 10 V depending on the manufacturer and type of the transmitter. The R_t load resistance determined from the equation:

$$U_{\text{transmitter_min}} < U_{\text{power}} - n * 4\text{mA} * (R_t + R_{\text{wire}})$$

where: U_{power} - voltage of the power supply
 n - number of transmitters in one loop
 R_{wire} - resistance of the cable

- the RC time-lag shall be calculated for the cable. The RC time-lag depends on the
 - R_t resistance;
 - quality of the cable (resistance, capacitance, isolation material);
 - input capacitance of the HART transmitters;
 - presence of other equipment in the loop.

The RC time-lag shall not exceed 65 microseconds.

Annex E. Drawings

I/O BOARDS WIRING TERMINALS

ANI8 0/4-20mA analogue input module		
Channel No	25-pin 'D sub' F	
	(+)	(-)
1	14	1
2	15	2
3	16	3
4	17	4
5	18	5
6	19	6
7	20	7
8	21	8
24V _{out}	22	9 (AGND)

PT4 Pt100 RTD input module		
Channel No	25-pin 'D sub' F	
	(+)	(-)
1	14 (U)	1 (U)
	15 (I)	2 (I)
2	16 (U)	3 (U)
	17 (I)	4 (I)
3	18 (U)	5 (U)
	19 (I)	6 (I)
4	20 (U)	7 (U)
	21 (I)	8 (I)
24V _{out}	22	9 (AGND)

ANI4/PT2 0/4-20mA analogue and Pt100 RTD input module		
Channel No	25-pin 'D sub' F	
	(+)	(-)
1	14	1
2	15	2
3	16	3
4	17	4
5	18(U)	5(U)
	Pt100 19(I)	6(I)
6	20(U)	7(U)
	Pt100 21(I)	8(I)
24V _{out}	22	9

AODIO484 0/4-20mA analogue and digital output and digital input module		
Channel No	25-pin 'D sub' F	
	(+)	(-)
1 (AO)	14	1
2 (AO)	15	2
3 (AO)	16	3
4 (AO)	17	4
5 (DI)	22	13
6 (DI)	9	13
7 (DI)	23	13
8 (DI)	10	13
9 (DI)	24	13
10 (DI)	11	13
11 (DI)	25	13
12 (DI)	12	13
13 (DO)	18	5
14 (DO)	19	6
15 (DO)	20	7
16 (DO)	21	8

HTI4x15 Input module for smart transmitters with HART protocol		
Loop No	25-pin 'D sub' F	
	(+)	(-)
1	14	1
2	15	2
3	16	3
4	17	4
24V _{out}	22	9 (AGND)

MB, Hot/stand-by interface and flow computer status	
Terminal label	Signal
O	Operating (output)
C	Common (output)
E	Fault (output)
+S	Sense+ (input)
-S	Sense- (input)

PDIO484 Pulse/frequency and digital input and digital output module		
Channel No	25-pin 'D sub' F	
	(+)	(-)
1 (PI)	14	1
2 (PI)	15	2
3 (PI)	16	3
4 (PI)	17	4
5 (DI)	22	13
6 (DI)	9	13
7 (DI)	23	13
8 (DI)	10	13
9 (DI)	24	13
10 (DI)	11	13
11 (DI)	25	13
12 (DI)	12	13
13 (DO)	18	5
14 (DO)	19	6
15 (DO)	20	7
16 (DO)	21	8

PITC4641 Pulse/frequency and digital input and pulse and digital output module		
Channel No	25-pin 'D sub' F	
	(+)	(-)
1 (PI)	14	1
2 (PI)	15	2
3 (PI)	16	3
4 (PI)	17	4
5 (DI)	22	13
6 (DI)	9	13
7 (DI)	23	13
8 (DI)	10	13
9 (DI)	24	13
10 (DI)	11	13
11 (DO)	18	5
12 (DO)	19	6
13 (DO)	20	7
14 (DO)	21	8
15 (PO)	25	12

NOTE

Maximum load of the 24V_{out} transmitter power output is 200 mA total (as sum of loads on every board providing transmitter power output).

Terminal pairs of the pulse inputs not in use must be connected together (short circuited).

Terminal pairs of the 4 terminal points of the RTD inputs not in use must be connected together (short circuited).

To maintain the accuracy of the analog inputs protective ground shall be connected to grounding pin (lower right corner of the backplane) even if unit is powered from 24 VDC power supply.

Terminal points in D-sub connectors
View from rear

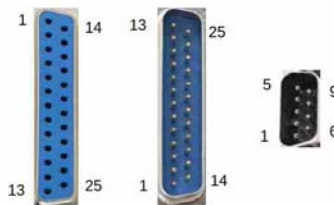

PI – pulse input
DI – digital input
DO – digital output
AO – analog output
PO – pulse output

I/O BOARDS WIRING TERMINALS (continued)

COM1, COM2, COM3			
9-pin 'D sub' M	RS232	RS485	RS422
1			
2	RxD		Rx+ (A)
3	TxD	RxTx-	Tx- (Z)
4			
5	GND	GND	GND
6			
7	RTS	RxTx+	Tx+ (Y)
8	CTS		Rx- (B)
9			

CX5 serial extension board			
25-pin 'D sub' M	RS232	RS485	RS422
COM4			
13	RxD		Rx+ (A)
12	TxD	RxTx-	Tx- (Z)
11	GND	GND	GND
25	RTS	RxTx+	Tx+ (Y)
24	CTS		Rx- (B)
COM5			
23	RxD		Rx+ (A)
22	TxD	RxTx-	Tx- (Z)
21	GND	GND	GND
10	RTS	RxTx+	Tx+ (Y)
9	CTS		Rx- (B)
COM6			
8	RxD		Rx+ (A)
7	TxD	RxTx-	Tx- (Z)
6	GND	GND	GND
20	RTS	RxTx+	Tx+ (Y)
19	CTS		Rx- (B)
COM7			
18	RxD		Rx+ (A)
17	TxD	RxTx-	Tx- (Z)
16	GND	GND	GND
5	RTS	RxTx+	Tx+ (Y)
4	CTS		Rx- (B)
COM8			
3	RxD		Rx+ (A)
2	TxD	RxTx-	Tx- (Z)
1	GND	GND	GND
15	RTS	RxTx+	Tx+ (Y)
14	CTS		Rx- (B)

Terminal points in D-sub connectors
View from rear

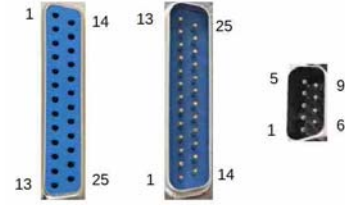

UNIFLOW-200 FLOW COMPUTER HW BLOCK SCHEMATIC

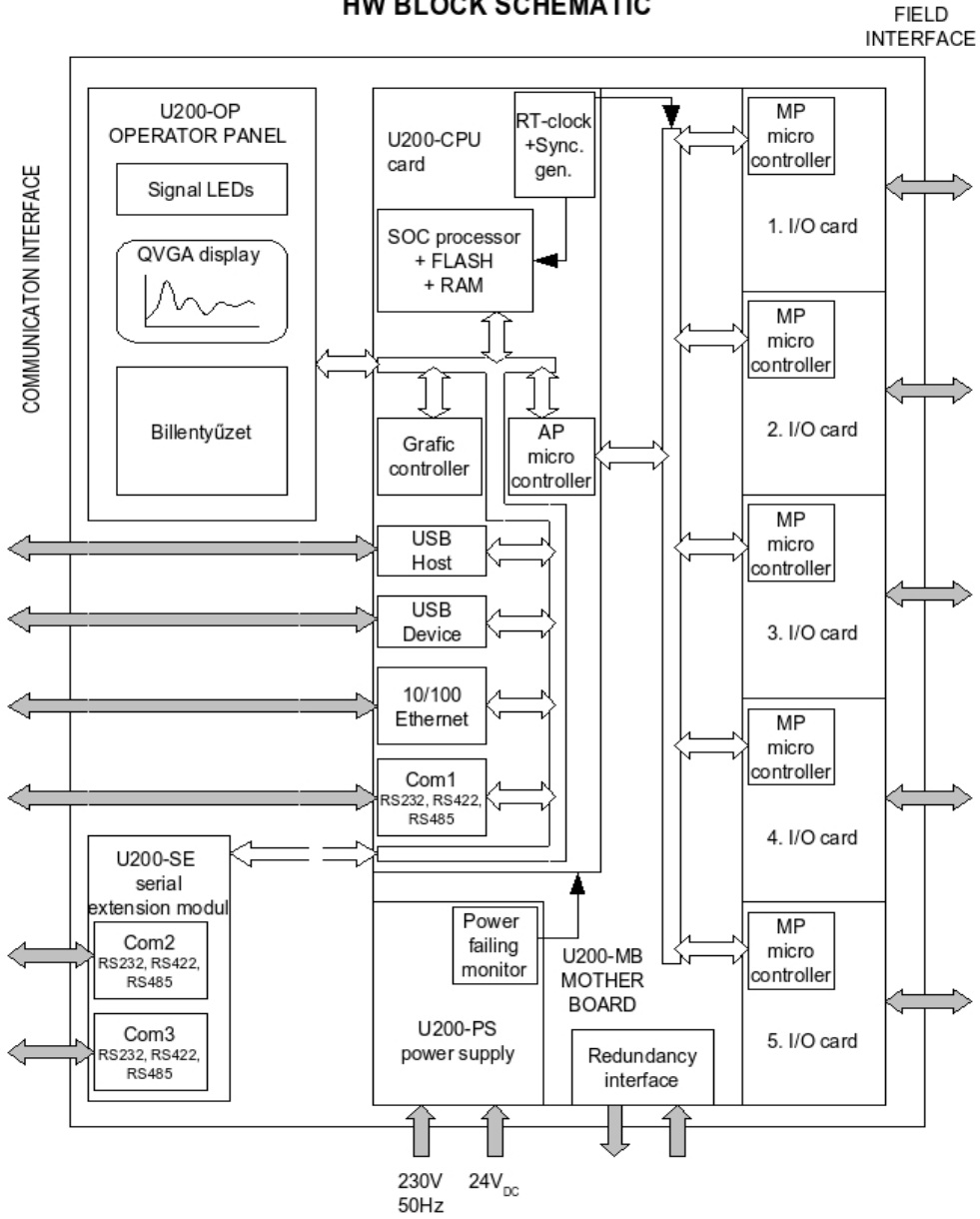

**UNIFLOW-200 FLOW COMPUTER
SW BLOCK SCHEMATIC**

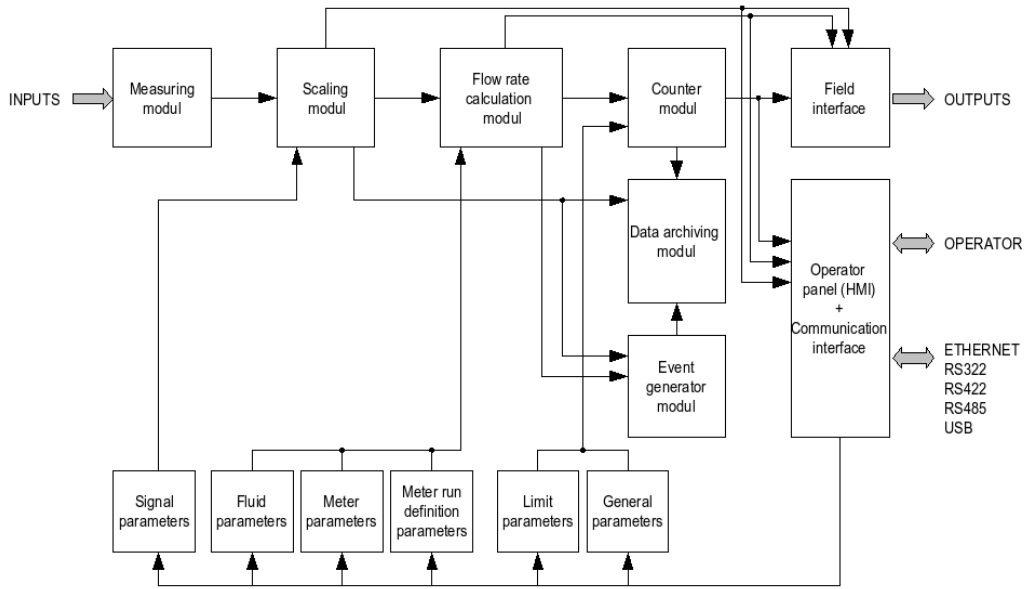

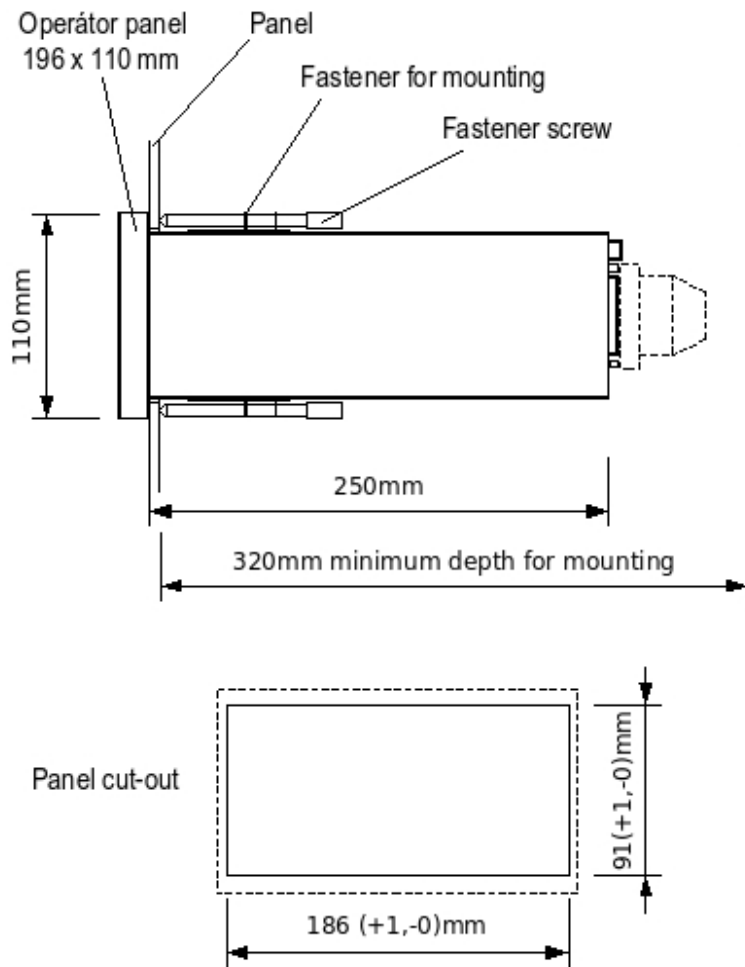

Mounting and cut-out

Manufacturer	Process Control Kft.	Type	UNIFLOW-200 MFC - 2 <input type="checkbox"/> 5 <input type="checkbox"/>
Serial No / Year of prod.	200-218 / 2013	Program ID	u2_cAA_1.1
Number of streams	max. 8	MPE Uncertainty	±0.03 % OIML R117, ±0.2 % EN12405 ±0.05 %
I/O boards	1. pos. ANI8	in: 8 x 4-20 mA	out: 1 x 24V _{DC} / 200 mA
	2. pos. PT4	in: 4 x Pt100	out: -
	3. pos. PDIO484	in: 4 x imp., 8 x DI	out: 4 x DO
	4. pos. AODIO484	in: 8 x DI	out: 4 x 4-20 mA, 4 x DO
	5. pos. HTI4x15	in: 4 x 15 HART PV	out: -
Communications	Ethernet <input checked="" type="checkbox"/> USB <input checked="" type="checkbox"/>	COM1 <input checked="" type="checkbox"/> COM2 <input type="checkbox"/> COM3 <input type="checkbox"/>	
Power supply	230V, 50Hz (24V _{DC})	Power consumption	25VA (21W) max.
Operating temperature	-10...60°C	Protection	IP20
EC-type Certificate (UNIFLOW-200 MFC - 2)	TH-8543/3/2008 EN 12405-1:2005	CE M08 1422	Evaluation Certificate (UNIFLOW-200 MFC - 5) TH-8614/5/2013 OIML R 117 Class 0,3

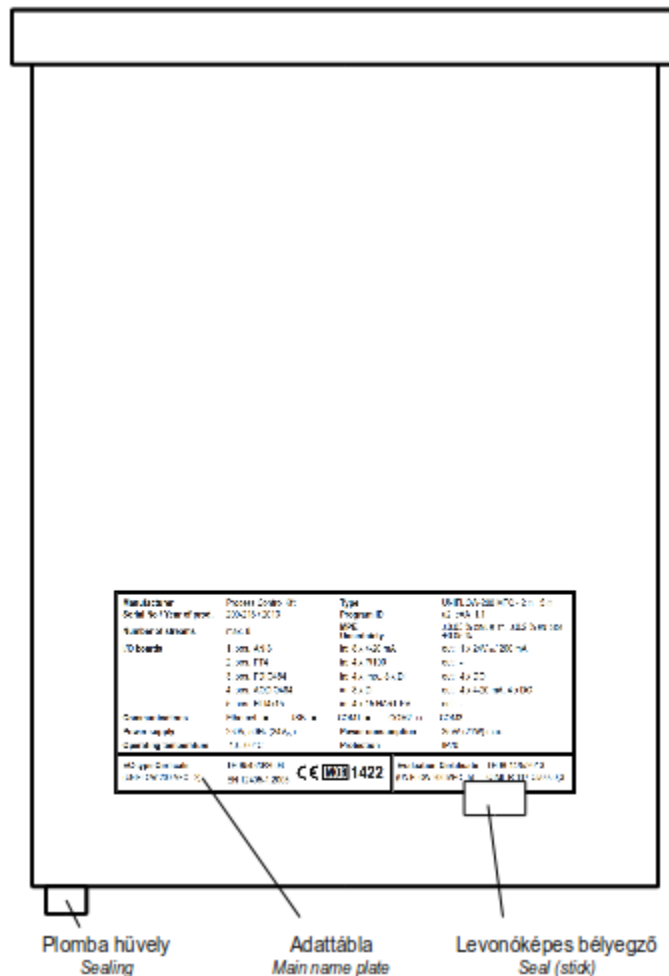

Main name plate and seal position

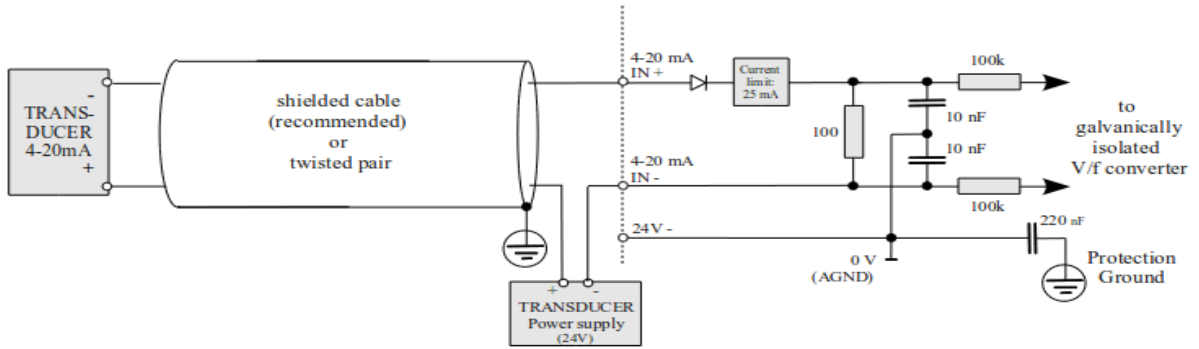

**4-20 mA Input and wiring
loop powered using satellite power supply**

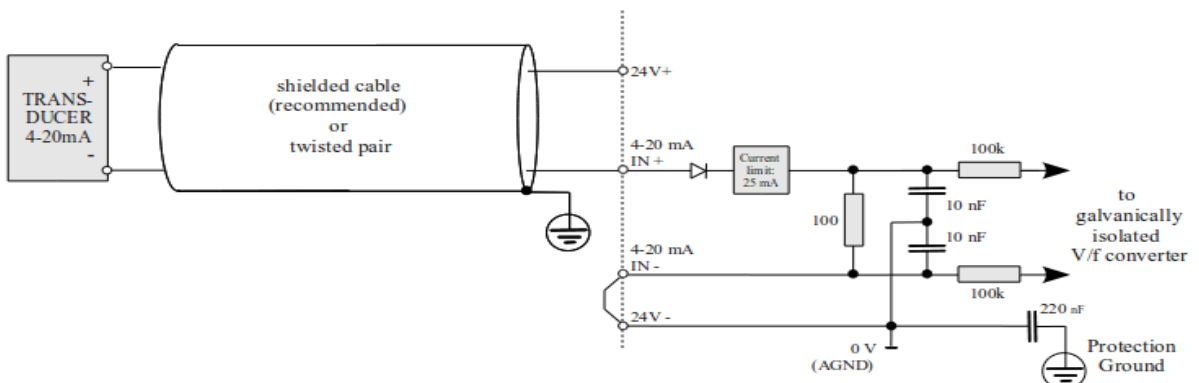

**4-20 mA Input and wiring
loop powered by the flow computer (1x24V, 20 mA max.)**

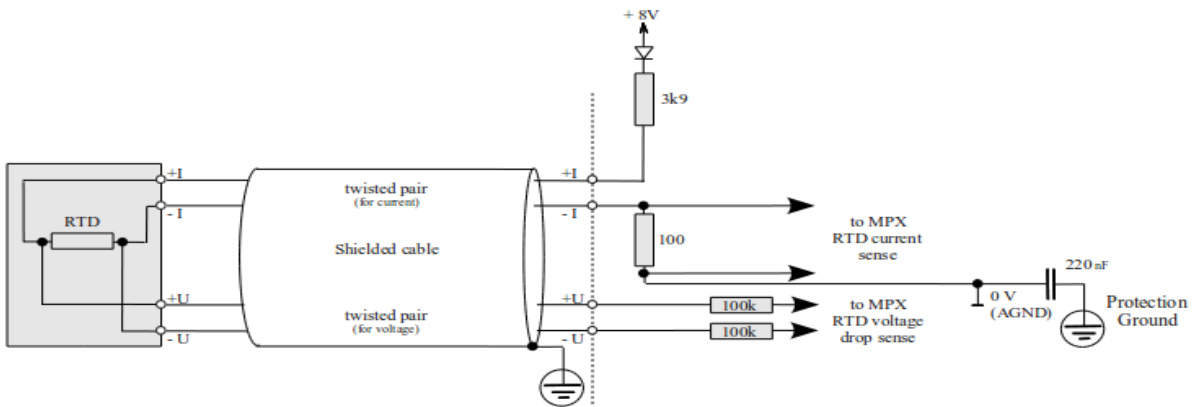

PRT/RTD Input and wiring

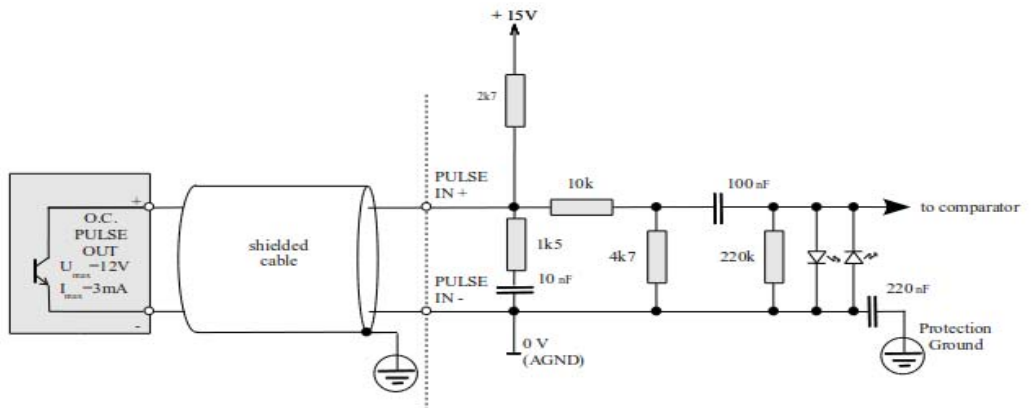

Pulse Input and wiring for transducers with Open Collector (NPN) output

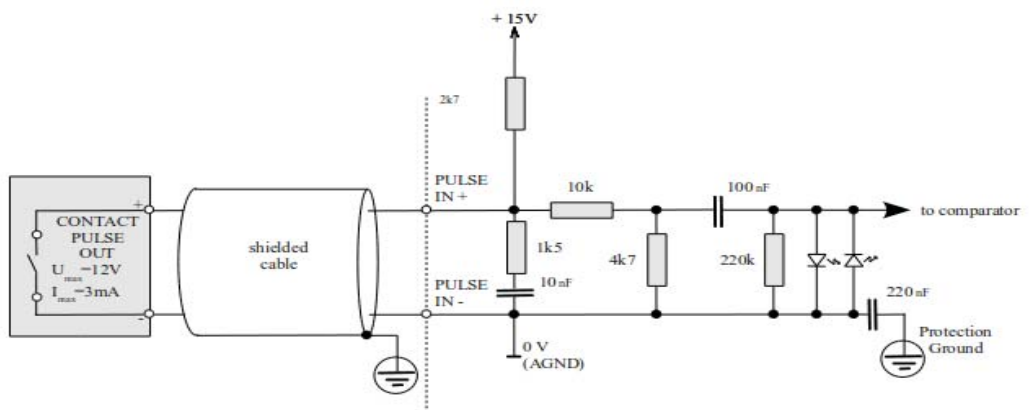

Pulse Input and wiring for transducers with potential free contact output

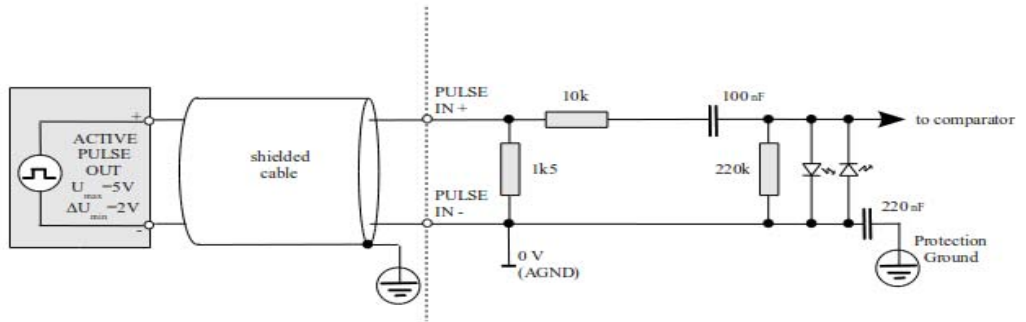
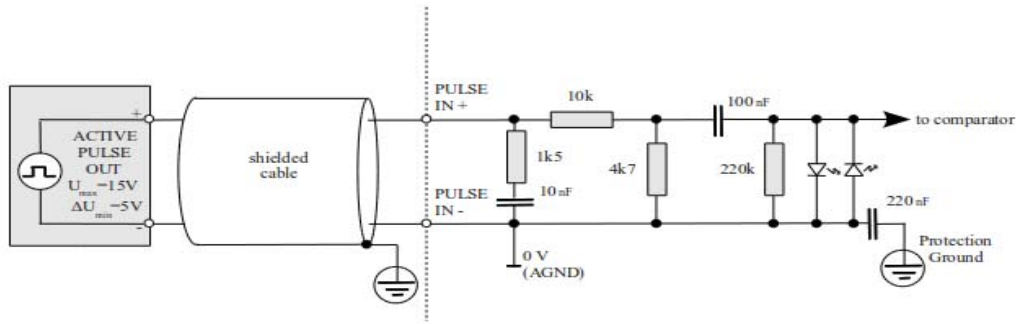

Pulse Input and wiring for transducers with voltage output

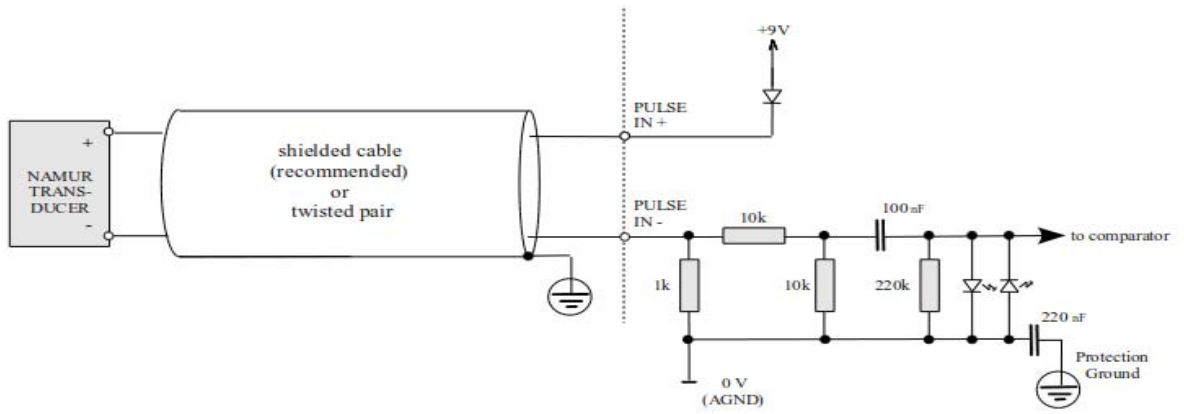

Pulse Input and wiring for transducers with voltage output

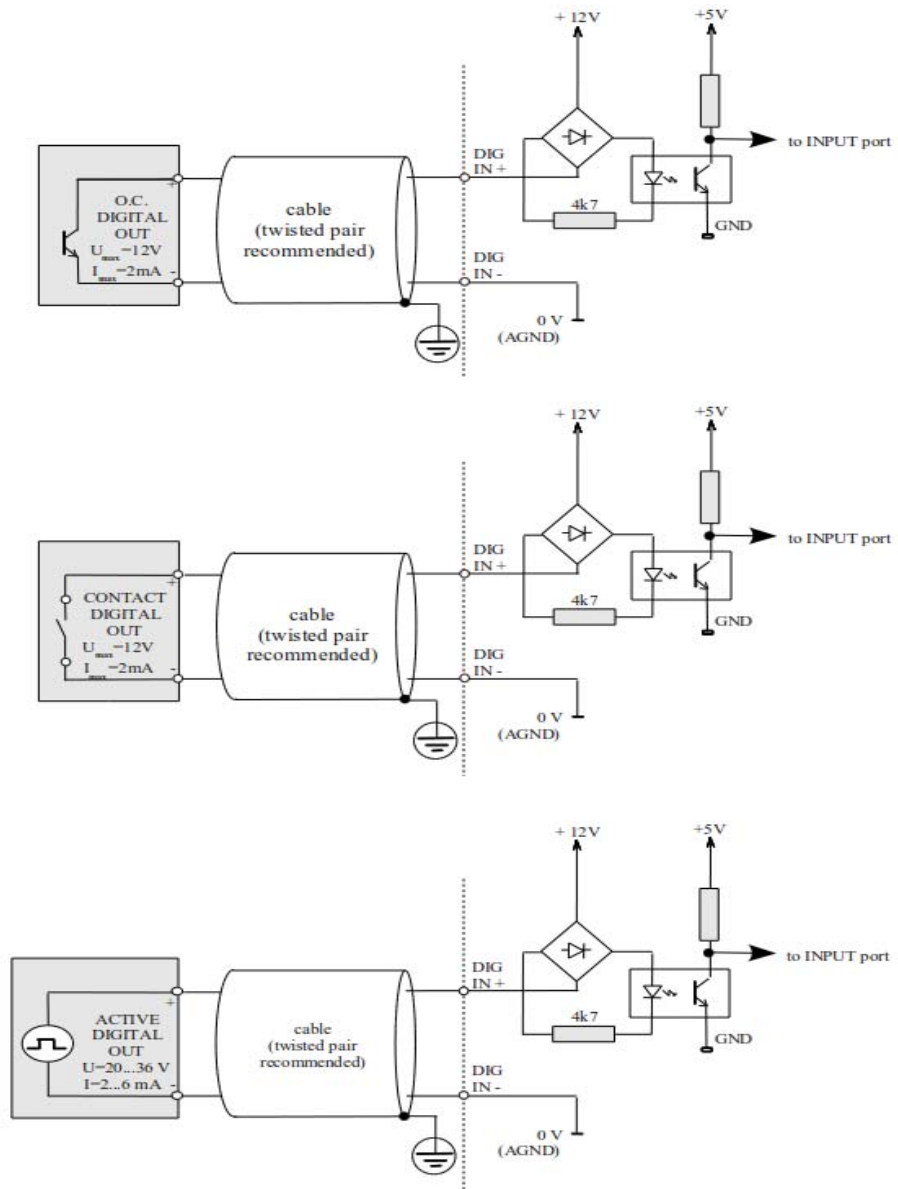

Digital Input and wiring

*** IMPORTANT!**
 The use of the relay coil switch-off transient absorbing diode (D) is **OBLIGATORY**.
 A missing diode can result in output damage!

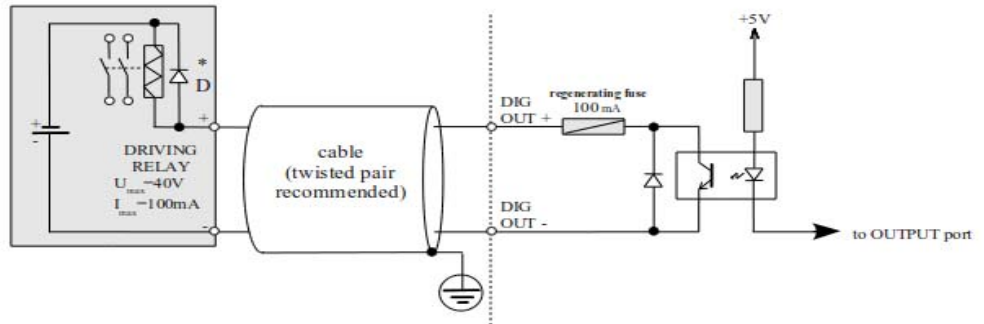

Digital Output and wiring

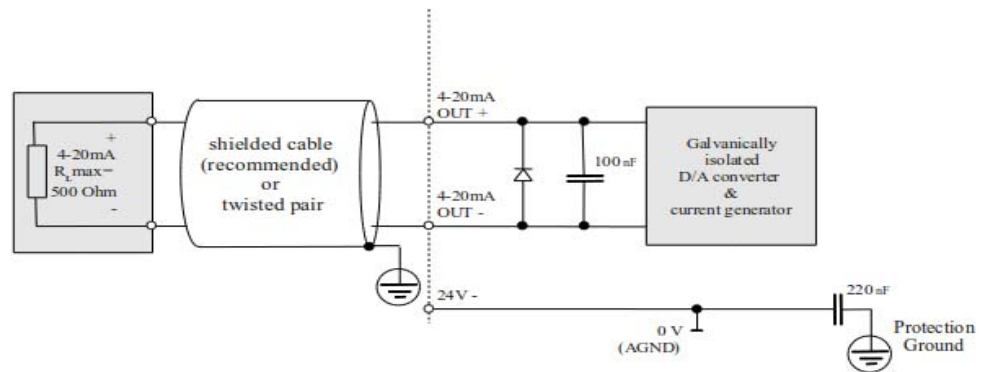

4-20 mA Output and wiring

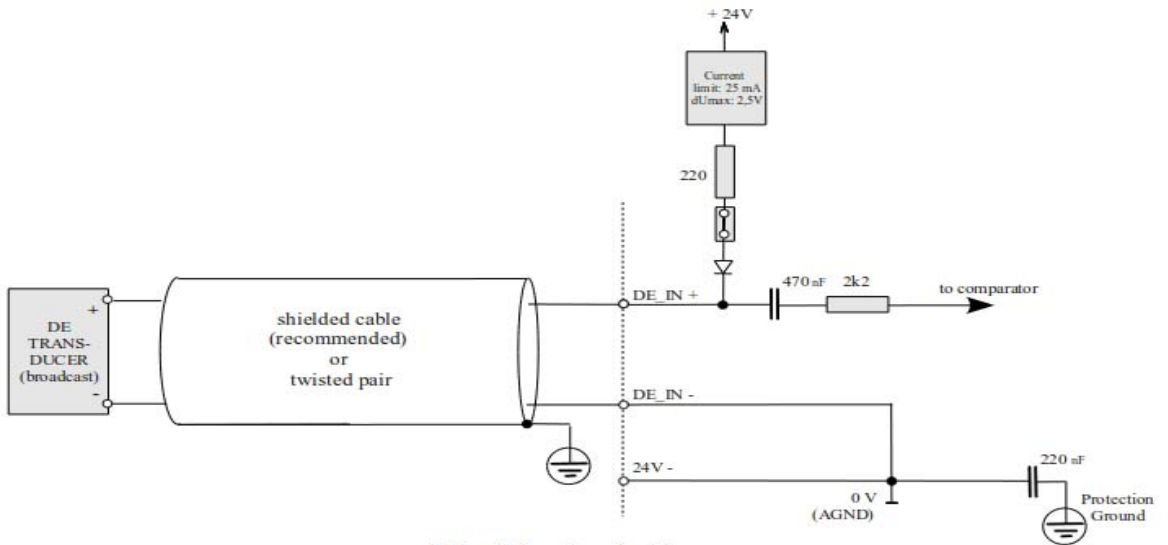

**4-20 mA Input and wiring
for transducers communicating by Honeywell DE protocol
loop powered by the flow computer**

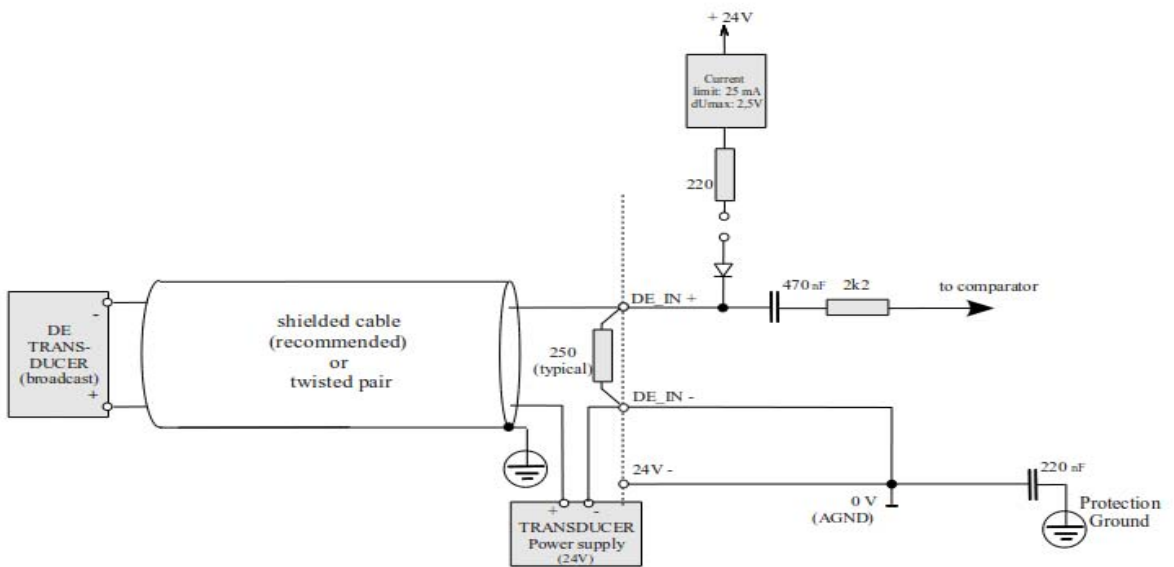

**4-20 mA Input and wiring
for transducers communicating by Honeywell DE protocol
loop powered using satellite power supply**

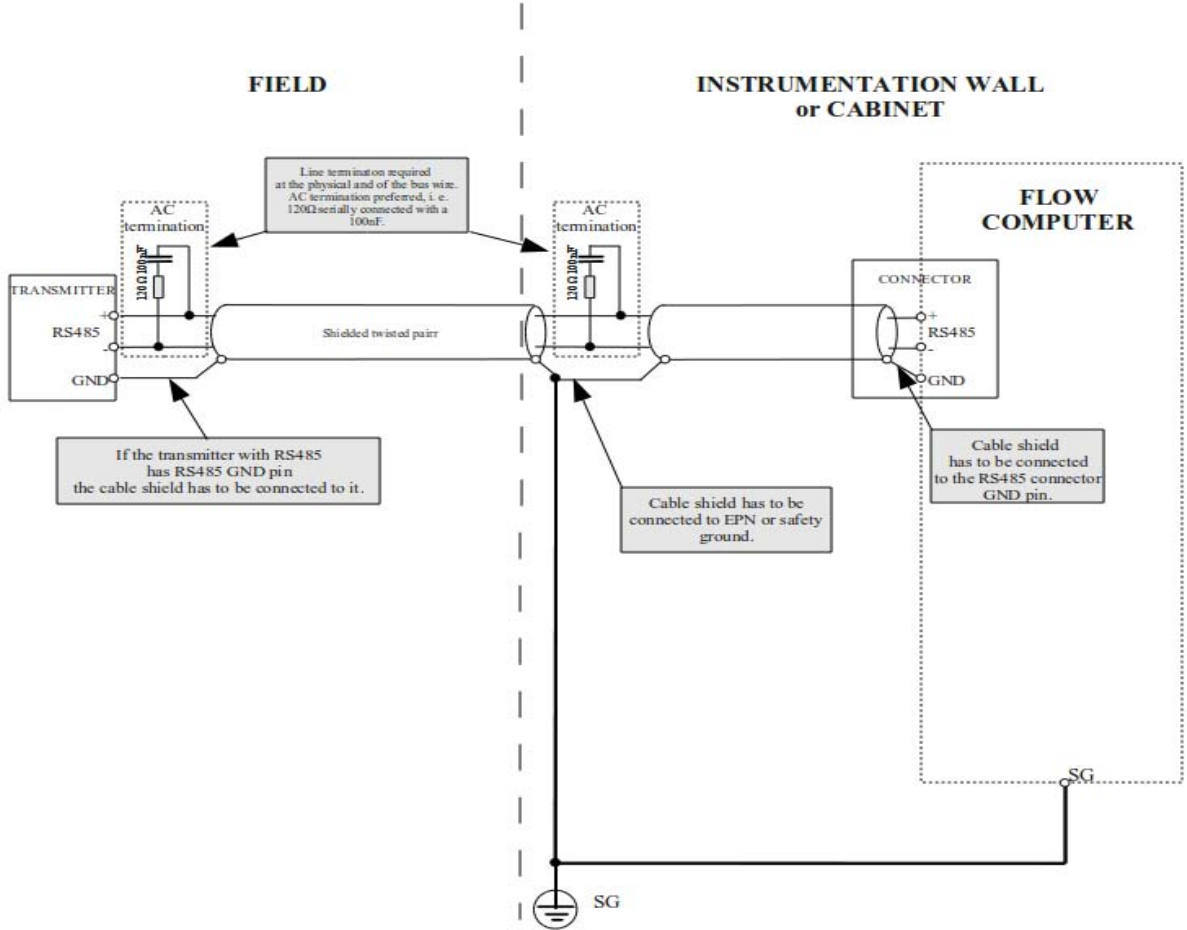

Connection to transmitter equipped with RS485 interface

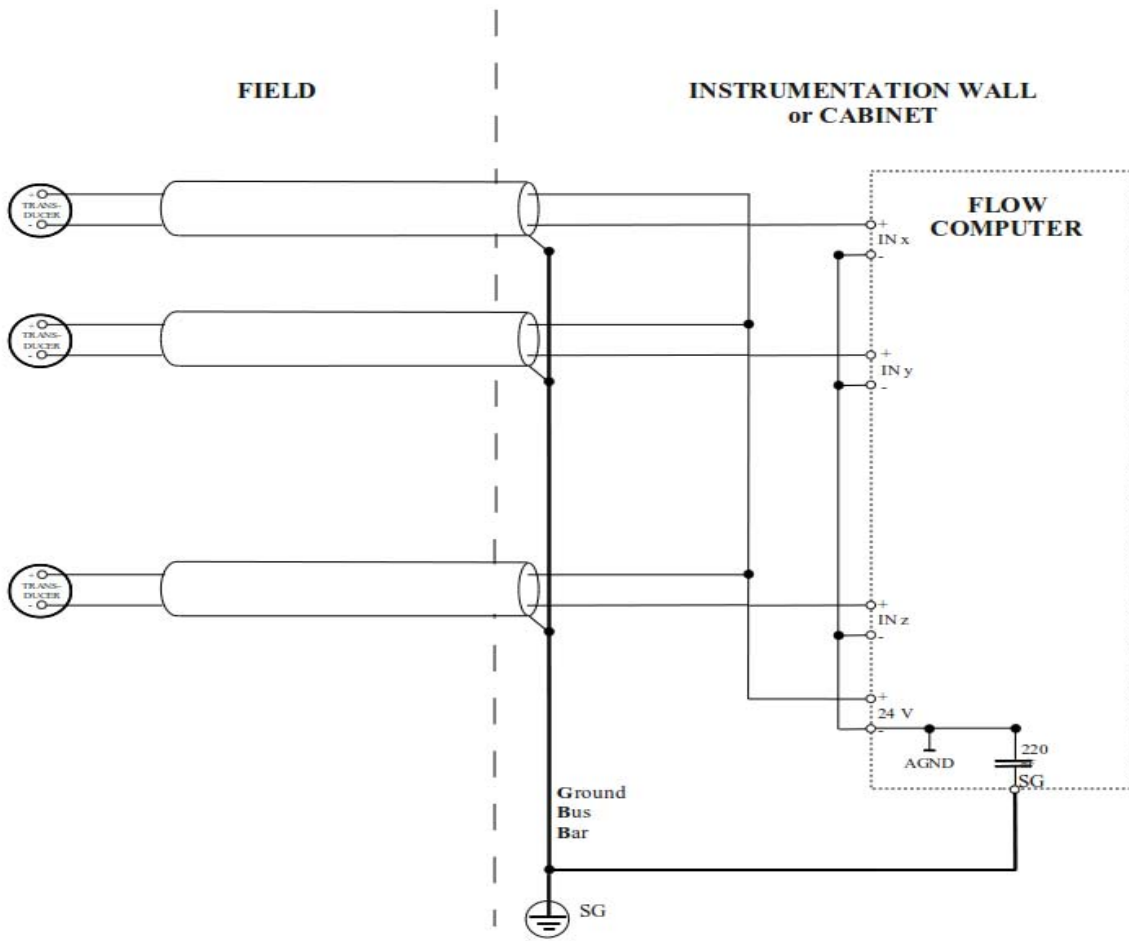

**Wiring of the 4-20 mA inputs,
loop powered by the flow computer**

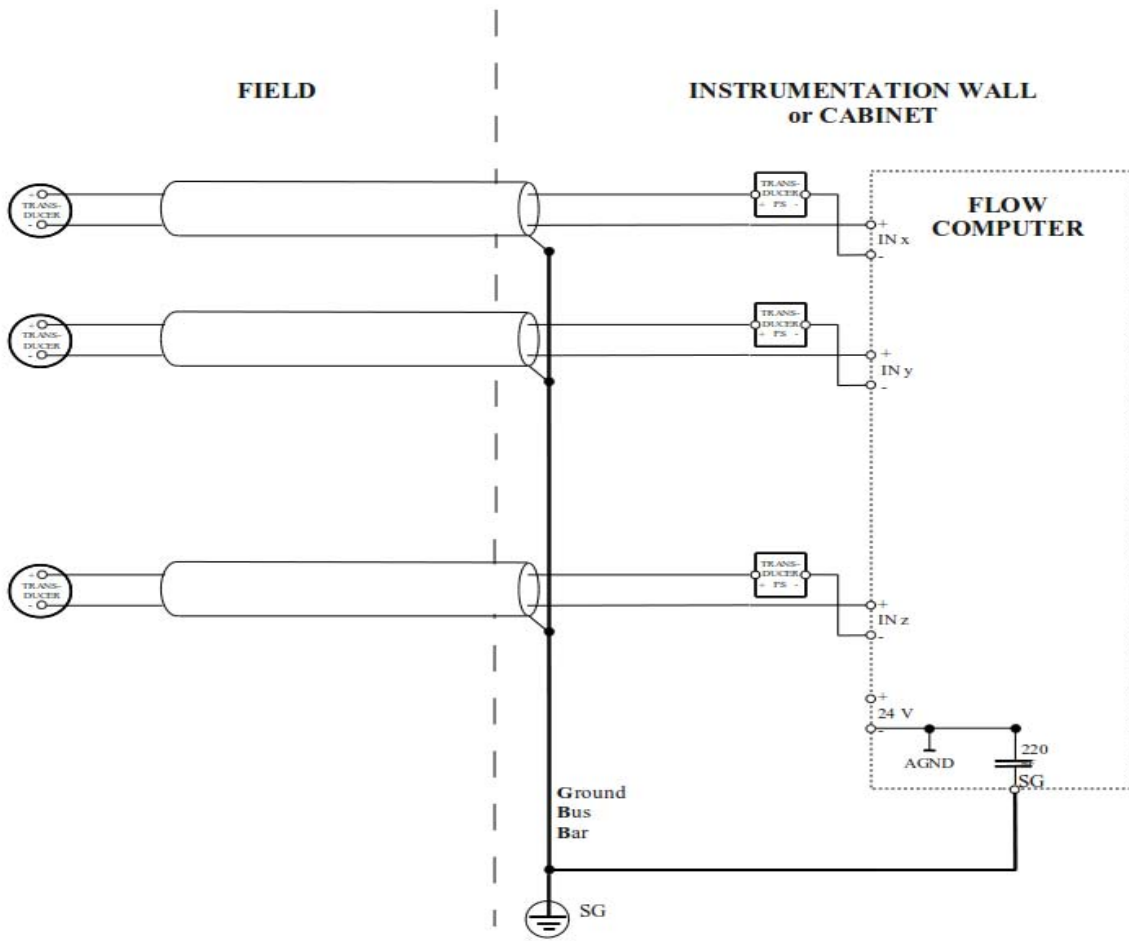

**Wiring of the 4-20 mA inputs,
loop powered using satellite power supplies**

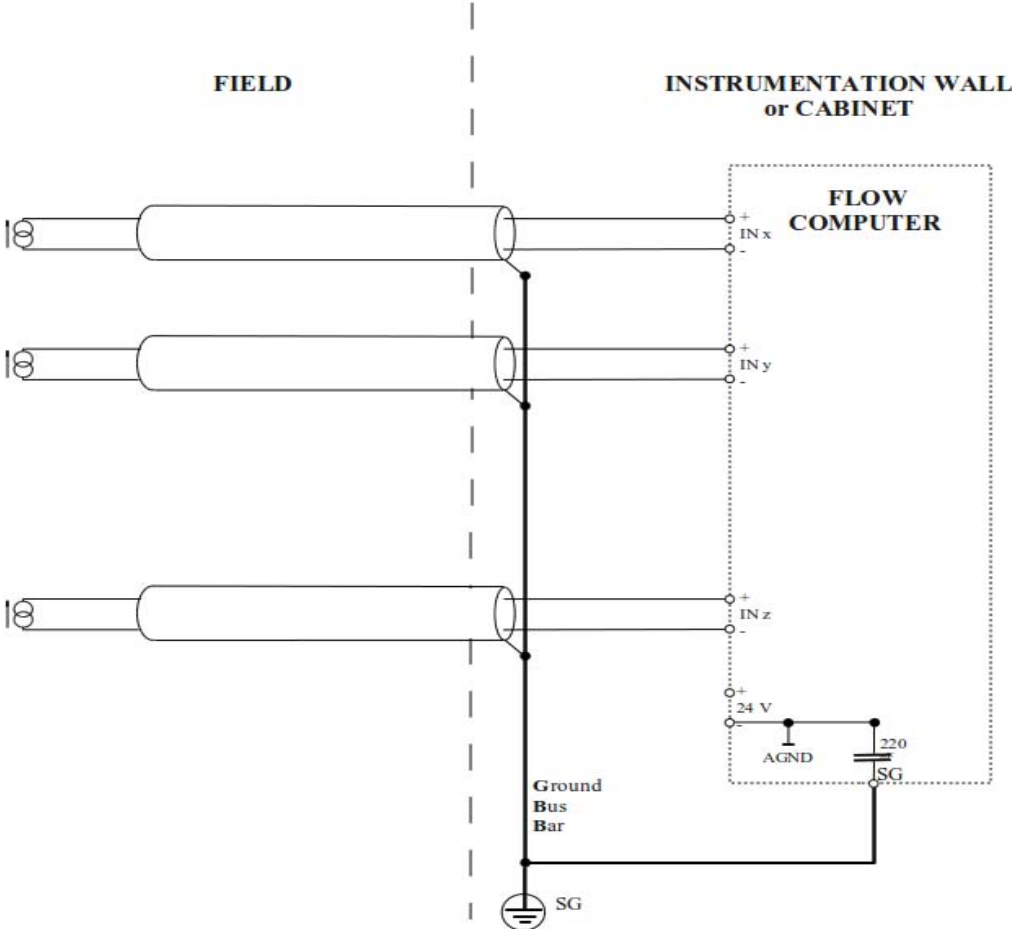

Wiring of the 4-20 mA inputs, transducers with active outputs isolated from the earth

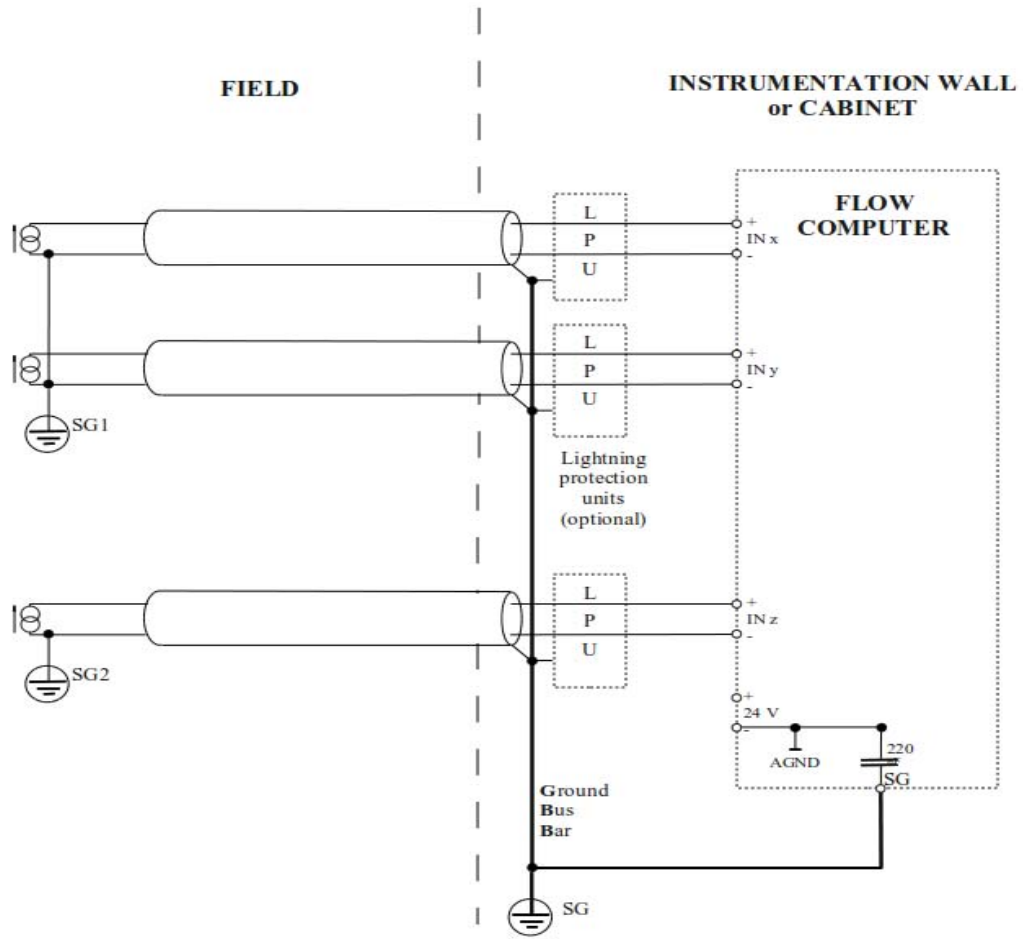

**Wiring of the 4-20 mA inputs,
transducers with active outputs connected to the earth
and optional lightning protection**

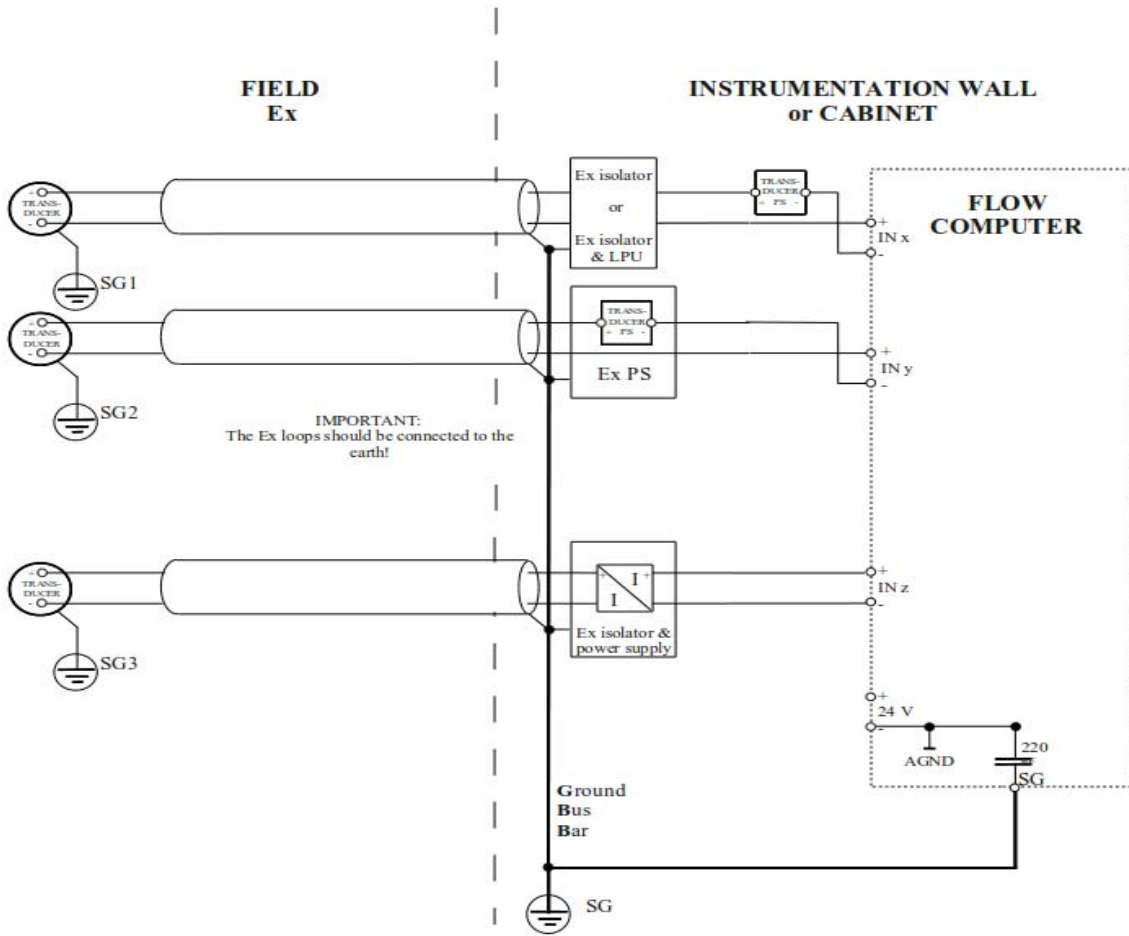

**Wiring of the 4-20 mA inputs
in case of explosive (Ex) environment**

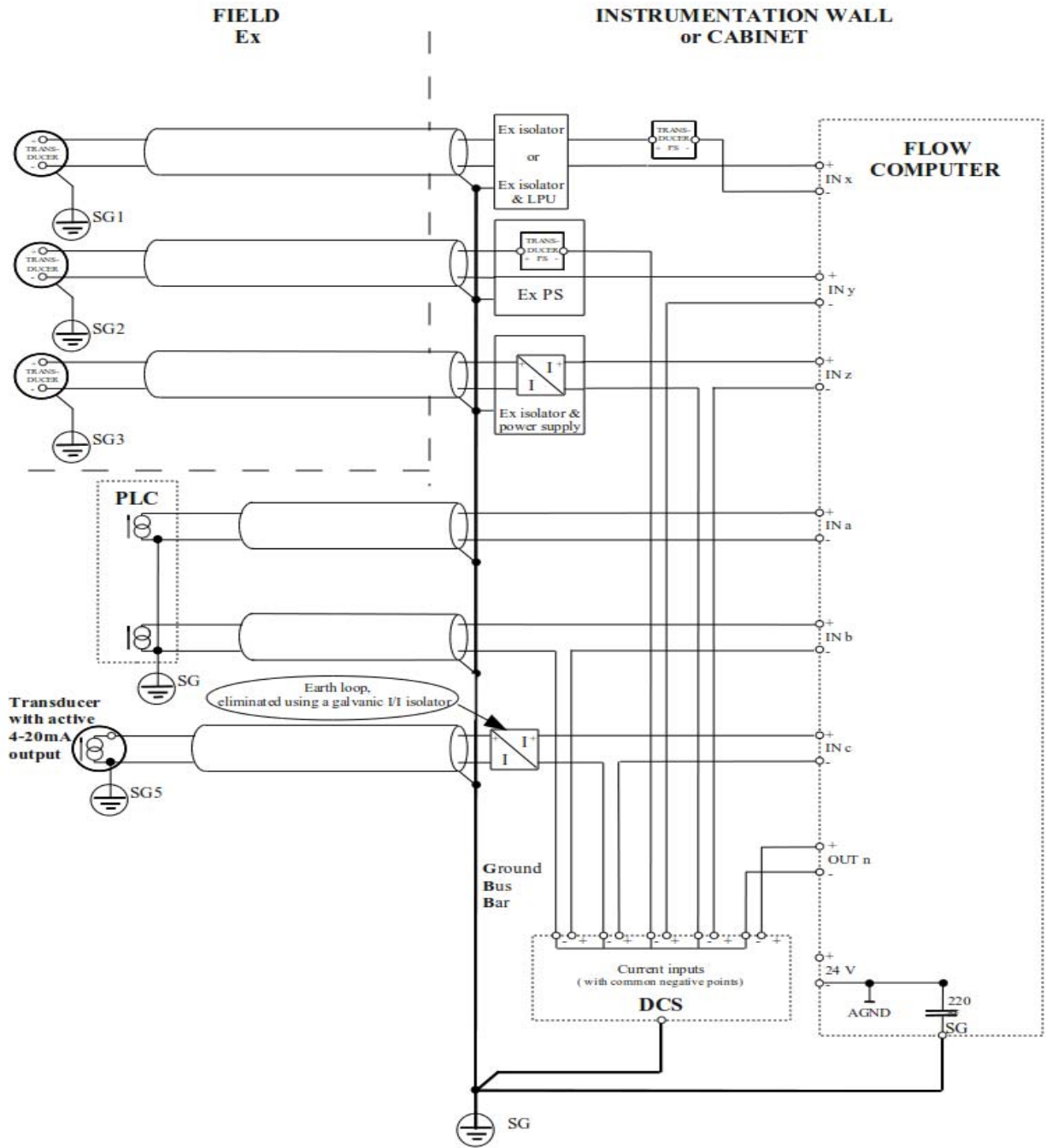

**Wiring of the 4-20 mA inputs
in case of different type devices,
connected to the earth in different places**

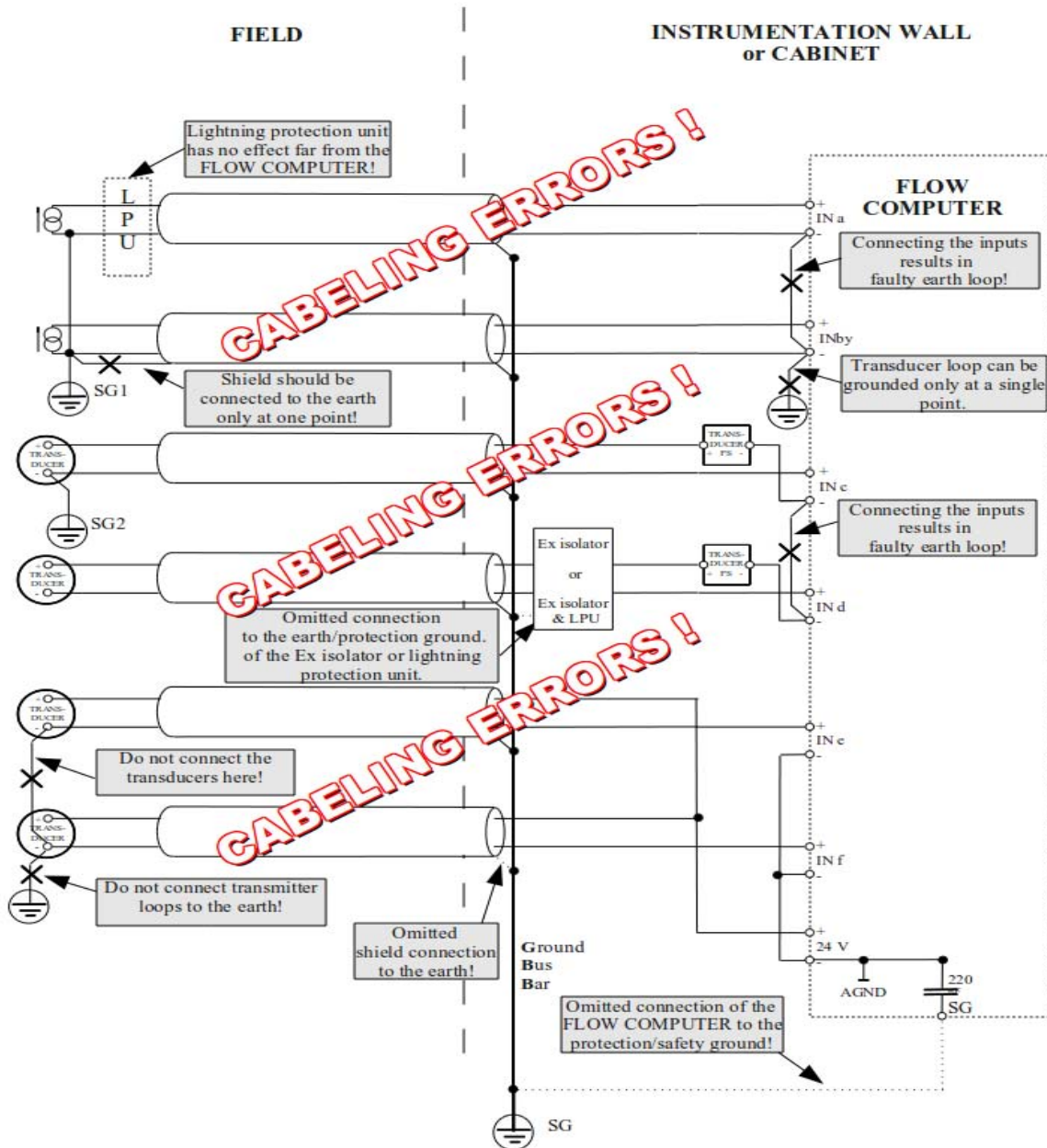

Typical mistakes of the 4-20 mA input wiring